



Bulletin 100-C/104-C — IEC Contactors

- Compact sizes from 4...55 kW/5...75 Hp (9...97 A)
- AC and DC coil control
- Common accessories for all contactor sizes
- Front and side mounting of auxiliary contacts
- Electronic and pneumatic timing modules
- Space-saving coil-mounted control modules
- Reversible coil terminations (line or load side)
- All devices can be attached to 35 mm DIN mounting Rail
- Environmentally friendly materials

The Bulletin 100-C/104-C IEC contactor family, along with a wide range of common accessories and Bulletin 193 solid-state overload relays, provides the most compact and flexible starter component system available.

Your order must include: cat. no. of the contactor specified with coil voltage code and, if required, cat. no. of any accessories and/or replacement coils.

Table of Contents

Product Selection..... this page
 Accessories..... 2-142
 Approximate
 Dimensions..... 2-194

Standards Compliance

EN/IEC 60947-4-1, 60947-5-1
 IEC 60947 Type “2”
 Coordination
 CSA C22.2 No. 14
 UL 508
 Meets the material restrictions
 for European Directive
 2002/95/IEC-EU-RoHS

Certifications

CE Marked
 cULus Listed (File No. E3125;
 Guide NLDX, NLDX7)
 CCC

Product Selection



3-Pole AC- and DC-Operated Contactors

I _e [A]		Ratings for Switching AC Motors — AC-2, AC-3, AC-4										Aux. Contacts		Cat. No.
		3-Phase kW (50 Hz)				Hp (60 Hz)						N.O.	N.C.	
AC-3	AC-1	230V	400V/415V	500V	690V	1-Phase		3-Phase						
						115V	230V	200V	230V	460V	575V			
9	32	3	4	4	4	1/2	1-1/2	2	2	5	7-1/2	1	0	‡ 100-C09⊗10
												0	1	‡ 100-C09⊗01
12	32	4	5.5	5.5	5.5	1/2	2	3	3	7-1/2	10	1	0	‡ 100-C12⊗10
												0	1	‡ 100-C12⊗01
16	32	5.5	7.5	7.5	7.5	1	3	5	5	10	15	1	0	‡ 100-C16⊗10
												0	1	‡ 100-C16⊗01
23	32	7.5	11	13	10	2	3	5	7-1/2	15	15	1	0	100-C23⊗10
												0	1	100-C23⊗01
30	65	10	15	15	15	2	5	7-1/2	10	20	25	0	0	100-C30⊗00
												1	0	100-C30⊗10
37	65	11	18.5/20	20	18.5	3	5	10	10	25	30	0	1	100-C30⊗01
												1	0	100-C37⊗10
43	85	13	22	25	22	3	7-1/2	10	15	30	30	0	0	100-C37⊗01
												1	0	100-C43⊗00
60	100	18.5	32	37	32	5	10	15	20	40	50	1	0	100-C43⊗10
												0	1	100-C43⊗01
72	100	22	40	45	40	5	15	20	25	50	60	0	0	100-C60⊗00
												1	0	100-C60⊗10
85	100	25	45	55	45	5	15	25	30	60	60	0	1	100-C60⊗01
												0	0	100-C72⊗00
97	130	30	55	55	55	10	15	30	30	75	75	1	0	100-C72⊗10
												0	1	100-C72⊗01
97	130	30	55	55	55	10	15	30	30	75	75	0	0	100-C85⊗00
												1	0	100-C85⊗10
97	130	30	55	55	55	10	15	30	30	75	75	0	1	100-C85⊗01
												0	0	100-C97⊗00
97	130	30	55	55	55	10	15	30	30	75	75	1	0	100-C97⊗10
												0	1	100-C97⊗01

‡ For screwless terminals, add an "R" after the letter "C" in the catalog number. Example: **Cat. No. 100-C09⊗10** becomes **Cat. No. 100-CR09⊗10**.

⊗ Coil voltage code and terminal position—see page 2-131

4-Pole AC- and DC-Operated Contactors

I_e [A]		Ratings for Switching AC Motors — AC-2, AC-3										Contact Configuration, Main Pole		Cat. No.	
		3-Phase kW (50 Hz)*					Hp (60 Hz)								
AC-3	AC-1	230V	400V/415V	500V	690V	1-Phase		3-Phase *						N.O.	N.C.
						115V	230V	200V	230V	460V	575V				
9	32	3	4	4	4	1/2	1-1/2	2	2	5	7-1/2	4	0	‡	100-C09Ⓢ400
												3	1	‡	100-C09Ⓢ300
												2	2	‡	100-C09Ⓢ200
12	32	4	5.5	5.5	5.5	1/2	2	3	3	7-1/2	10	4	0	‡	100-C12Ⓢ400
												3	1	‡	100-C12Ⓢ300
												2	2	‡	100-C12Ⓢ200
16	32	5.5	7.5	7.5	7.5	1	3	5	5	10	15	4	0	‡	100-C16Ⓢ400
												3	1	‡	100-C16Ⓢ300
												2	2	‡	100-C16Ⓢ200
23	32	7.5	11	13	10	2	3	5	7-1/2	15	15	4	0		100-C23Ⓢ400
												3	1		100-C23Ⓢ300
												2	2		100-C23Ⓢ200
37	75	11	18.5/20	20	18.5	3	5	10	10	25	30	4	0		100-C40Ⓢ400
												2	2		100-C40Ⓢ200
85	130	25	45	55	45	7-1/2	15	25	30	60	50	4	0		100-C90Ⓢ400
												2	2		100-C90Ⓢ200

* Three-phase ratings apply only to contactors with at least three N.O. power poles.

‡ For screwless terminals, add an "R" after the letter "C" in the catalog number. Example: **Cat. No. 100-C09Ⓢ400** becomes **Cat. No. 100-CR09Ⓢ400**.

Ⓢ Coil voltage code and terminal position—see page 2-131

Reversing AC- and DC-Operated Contactors



Cat. No. 104-C09D22



Cat. No. 104-C30ZJ22



Cat. No. 104-C85D22

I _e [A]		Ratings for Switching AC Motors — AC-2, AC-3, AC-4										Auxiliary Contacts Installed per Contactor		Cat. No.
		3-Phase kW (50 Hz)					Hp (60 Hz)					N.O.	N.C.*	
		AC-3	AC-1	230V	400V/415V	500V	690V	1-Phase		3-Phase				
						115V	230V	200V	230V	460V	575V			
9	32	3	4	4	4	1/2	1-1/2	2	2	5	7-1/2	1	1	104-C09⊗22
12	32	4	5.5	5.5	5.5	1/2	2	3	3	7-1/2	10	1	1	104-C12⊗22
16	32	5.5	7.5	7.5	7.5	1	3	5	5	10	15	1	1	104-C16⊗22
23	32	7.5	11	13	10	2	3	5	7-1/2	15	15	1	1	104-C23⊗22
30	65	10	15	15	15	2	5	7-1/2	10	20	25	0	1	104-C30⊗02
												1	1	104-C30⊗22
37	65	11	18.5/20	20	18.5	3	5	10	10	25	30	0	1	104-C37⊗02
												1	1	104-C37⊗22
43	85	13	22	25	22	3	7.5	10	15	30	30	0	1	104-C43⊗02
												1	1	104-C43⊗22
60	100	18.5	32	37	32	5	10	15	20	40	50	0	1	104-C60⊗02
												1	1	104-C60⊗22
72	100	22	40	45	40	5	15	20	25	50	60	0	1	104-C72⊗02
												1	1	104-C72⊗22
85	100	25	45	55	45	7-1/2	15	25	30	60	60	0	1	104-C85⊗02
												1	1	104-C85⊗22
97	130	30	55	55	55	10	15	30	30	75	75	0	1	104-C97⊗02
												1	1	104-C97⊗22

* The N.C. auxiliary contact is supplied as part of the mechanical/electrical interlock.

⊗ Coil Voltage Code and Terminal Position

The Cat. No. as listed is incomplete. Select a coil voltage code from the table below to complete the Cat. No. Example: 120V, 60Hz:

Cat. No. 100-C09⊗10 becomes Cat. No. 100-C09D10.

[M]	12	24	32	36	42	48	100	100-110	110	120	127	200	200-220	208	208-240	220-230	230	230-240	240	277	347	380	380-400	400	400-415	440	480	500	550	600
50 Hz	R	K	V	W	X	Y	KP	—	D	P	S	KG	L	—	—	F	—	VA	T	—	—	—	N	—	G	B	—	M	C	—
60 Hz	Q	J	—	V	—	X	—	KP	—	D	—	—	KG	H	L	—	—	—	A	T	I	E	—	—	N	B	—	—	—	C
50/60 Hz	—	KJ	—	—	—	KY	KP	—	KD	—	—	KG	KL‡	—	—	KL‡	KF	—	KA	—	—	—	—	—	KN	—	KB	—	—	—

‡ Not available on 100/104-C90 or -C97 contactors.

DC Voltages [V]		9	12	24	36	48	48-72	60	64	72	80	110	110-125	115	125	220	220-250	230	250
100-C09...C43	Standard	ZR	ZQ	ZJ	ZW	ZY	—	ZZ	ZB	ZG	ZE	ZD	—	ZP	ZS	ZA	—	ZF	ZT
	with Integrated Diode	—	—	DJ	—	—	—	—	—	—	—	—	—	—	—	—	—	—	—
	Electronic with Integrated Diode	—	EQ	EJ	—	—	EY	—	—	—	—	—	ED	—	—	—	EA	—	—
100-C60...C97	with Integrated Diode	DR	DQ	DJ	DW	DY	—	DZ	DB	DG	DE	DD	—	DP	DS	DA	—	DF	DT

Coil Terminal Position

- All contactors are delivered with the coil terminals located on the **line side**.
- For **load side** coil terminations, insert a “U” prior to the coil voltage code. Ordering example: **Cat. No. 100-C09UD10**.

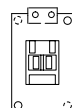

Cat. No. 100-C09⊗10
Line Side

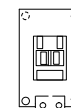

Cat. No. 100-C09U⊗10
Load Side

Bulletin 100 Line
IEC Contactors
 Assignment of Contacts

Assignment of Contacts

Auxiliary Contact Blocks		Contactors 100-C (AC and DC Control)							
			100-C09_@10 100-C12_@10 100-C16_@10 100-C23_@10	100-C09_@01 100-C12_@01 100-C16_@01 100-C23_@01	100-C30_@00 100-C37_@00 100-C43_@00 100-C60_@00 100-C72_@00 100-C85_@00 100-C97_@00	100-C09_@400 100-C12_@400 100-C16_@400 100-C23_@400 100-C40_@400 100-C90_@400	100-C09_@300 100-C12_@300 100-C16_@300 100-C23_@300	100-C09_@200 100-C12_@200 100-C16_@200 100-C23_@200 100-C40_@200 100-C90_@200	
	Circuit Diagram	Control							
Side Mounting *									
100-SB01		AC/DC	10 + 01 = 11	01 + 01 = 02 ‡	00 + 01 = 01	00 + 01 = 01	00 + 01 = 01	00 + 01 = 01	
100-SB10		AC/DC	10 + 10 = 20 ‡	01 + 10 = 11	00 + 10 = 10	00 + 10 = 10	00 + 10 = 10	00 + 10 = 10	
100-SB02		AC/DC	10 + 02 = 12 ‡	—	00 + 02 = 02	00 + 02 = 02	00 + 02 = 02	00 + 02 = 02	
100-SB11		AC/DC	10 + 11 = 21 ‡	01 + 11 = 12 ‡	00 + 11 = 11	00 + 11 = 11	00 + 11 = 11	00 + 11 = 11	
100-SB20		AC/DC	10 + 20 = 30 ‡	01 + 20 = 21 ‡	00 + 20 = 20	00 + 20 = 20	00 + 20 = 20	00 + 20 = 20	
100-SBL11 * ‡		AC/DC	10 + L11 = L21 ‡	01 + L11 = L12 ‡	00 + L11 = L11	00 + L11 = L11	00 + L11 = L11	00 + L11 = L11	

* Up to 8 auxiliary contacts possible: contactor + front mounted (AC max. 4 N.C. / DC max. 4 N.C.), side mounted (AC max. 2 N.O. / DC max. 2 N.O. and max. 2 N.C.).

‡ Early make and/or late break.

‡ Double numbering: because of double numbering only left-side mounting is recommended.

2

Device Combinations in Accordance with IEC 60947-1 / -4-1

Auxiliary Contact Blocks		Contactors 100-C (AC and DC Control)							
			100-C09_⊗10 100-C12_⊗10 100-C16_⊗10 100-C23_⊗10	100-C09_⊗01 100-C12_⊗01 100-C16_⊗01 100-C23_⊗01	100-C30_⊗00 100-C37_⊗00 100-C43_⊗00 100-C60_⊗00 100-C72_⊗00 100-C85_⊗00 100-C97_⊗00	100-C09_⊗400 100-C12_⊗400 100-C16_⊗400 100-C23_⊗400 100-C40_⊗400 100-C90_⊗400	100-C09_⊗300 100-C12_⊗300 100-C16_⊗300 100-C23_⊗300	100-C09_⊗200 100-C12_⊗200 100-C16_⊗200 100-C23_⊗200 100-C40_⊗200 100-C90_⊗200	
Circuit Diagram	Control								
Front Mounting *									
100-FA02, 100-FAB02		AC/DC	10 + 02 = 12	01 + 02 = 03	00 + 02 = 02	00 + 02 = 02	00 + 02 = 02	00 + 02 = 02	
100-FA11, 100-FAB11		AC/DC	10 + 11 = 21	01 + 11 = 12	00 + 11 = 11	00 + 11 = 11	00 + 11 = 11	00 + 11 = 11	
100-FB11, 100-FBB11		AC/DC	—	—	00 + 11 = 11	00 + 11 = 11	00 + 11 = 11	00 + 11 = 11	
100-FC11, 100-FCB11		AC/DC	10 + 11 = 21	—	—	—	—	—	
100-FA20, 100-FAB20		AC/DC	10 + 20 = 30	01 + 20 = 21	00 + 20 = 20	00 + 20 = 20	00 + 20 = 20	00 + 20 = 20	
100-FBL11 †		AC/DC	—	—	00 + L11 = L11	00 + L11 = L11	00 + L11 = L11	00 + L11 = L11	
100-FA22, 100-FAB22		AC/DC	10 + 22 = 32	01 + 22 = 23	00 + 22 = 22	00 + 22 = 22	00 + 22 = 22	00 + 22 = 22	
100-FB22, 100-FBB22		AC/DC	—	—	00 + 22 = 22	00 + 22 = 22	00 + 22 = 22	00 + 22 = 22	
100-FC22, 100-FCB22		AC/DC	10 + 22 = 32	—	—	—	—	—	
100-FA31, 100-FAB31		AC/DC	10 + 31 = 41	01 + 31 = 32	00 + 31 = 31	00 + 31 = 31	00 + 31 = 31	00 + 31 = 31	
100-FA40, 100-FAB40		AC/DC	10 + 40 = 50	01 + 40 = 41	00 + 40 = 40	00 + 40 = 40	00 + 40 = 40	00 + 40 = 40	
100-FAL22 †		AC/DC	10 + L22 = L32	01 + L22 = L23	00 + L22 = L22	00 + L22 = L22	00 + L22 = L22	00 + L22 = L22	
100-FA04, 100-FAB04		AC/DC	10 + 04 = 14	01 + 04 = 05	00 + 04 = 04	00 + 04 = 04	00 + 04 = 04	00 + 04 = 04	
100-FA13, 100-FAB13		AC/DC	10 + 13 = 23	01 + 13 = 14	00 + 13 = 13	00 + 13 = 13	00 + 13 = 13	00 + 13 = 13	
100-FB02, 100-FBB02		AC/DC	10 + 02 = 12	01 + 02 = 03	00 + 02 = 02	00 + 02 = 02	00 + 02 = 02	00 + 02 = 02	
100-FB20, 100-FBB20		AC/DC	10 + 20 = 30	01 + 20 = 21	00 + 20 = 20	00 + 20 = 20	00 + 20 = 20	00 + 20 = 20	
100-FC31, 100-FCB31		AC/DC	10 + 31 = 41	01 + 31 = 32	00 + 31 = 31	00 + 31 = 31	00 + 31 = 31	00 + 31 = 31	







* Up to 8 auxiliary contacts possible: contactor + front mounted (AC max. 4 N.C. / DC max. 4 N.C.), side mounted (AC max. 2 N.O. / DC max. 2 N.O. and max. 2 N.C.).

† Early make and/or late break.

‡ Double numbering: because of double numbering only left-side mounting is recommended.

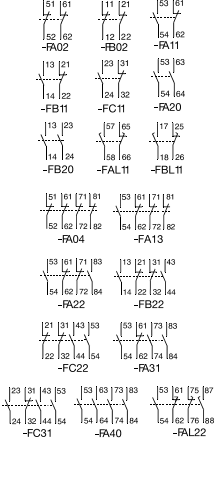
Auxiliary Contacts (For 100-C09...C97 contactors)

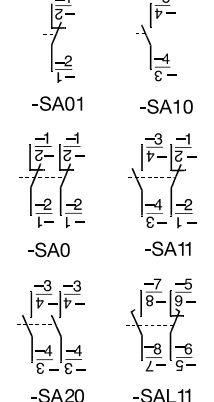
2

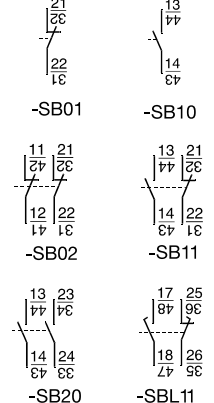
	Description			Connection Diagrams	For Use With	Standard Auxiliary Contact Cat. No. ‡	Bifurcated Auxiliary Contact Cat. No.		
		N.O.	N.C.						
 <p>Auxiliary Contact Blocks for Front Mounting*</p> <ul style="list-style-type: none"> • 2- and 4-pole • Quick and easy mounting without tools • Electronic-compatible contacts down to 17V, 5 mA • Mechanically linked performance between N.O. and N.C. poles and to the main contactor poles (except for L types) • Models with equal function with several terminal numbering choices • 1L = Late break N.C./early make N.O. • Bifurcated version for switching down to 5V, 3 mA also available 		0	2		100-C all	100-FA02	100-FAB02		
		1	1		C30®00...C97®00	100-FB02	100-FBB02		
		2	0		100-C all	100-FA11	100-FAB11		
		1L	1L		C30®00...C97®00	100-FB11	100-FBB11		
		0	4		C09®10...C23®10	100-FC11	100-FCB11		
		1	3		100-C all	100-FA20	100-FAB20		
		2	2		C30®00...C97®00	100-FB20	100-FBB20		
		3	1		100-C all	100-FAL11	—		
		4	0		C30®00...C97®00	100-FBL11	—		
		1+1L	1+1L		100-C all	100-FA04	100-FAB04		
	 <p>Auxiliary Contact Blocks for Side Mounting without Sequence Terminal Designations*</p> <ul style="list-style-type: none"> • 1- and 2-pole • Two-way numbering for right or left mounting on the contactor • Quick and easy mounting without tools • Electronic-compatible contacts down to 17V, 10 mA • Mirror contact performance to the main contactor poles • 1L = Late break N.C./early make N.O. 		0		1		100-C all	100-SA01	—
			1		0		100-C all	100-SA10	—
		0	2	100-C all	100-SA02		—		
		1	1	100-C all	100-SA11		—		
		2	0	100-C all	100-SA20		—		
		1L	1L	100-C all	100-SAL11		—		
 <p>Auxiliary Contact Blocks for Side Mounting with Sequence Terminal Designations*</p> <ul style="list-style-type: none"> • 1- and 2-pole • Two-way numbering for right or left mounting on the contactor • Quick and easy mounting without tools • Electronic-compatible contacts down to 17V, 10 mA • Mirror contact performance to the main contactor poles • 1L = Late break N.C./early make N.O. 		0	1		100-C	100-SB01	—		
		1	0		100-C*	100-SB10	—		
		0	2		100-C*	100-SB02	—		
		1	1		100-C*	100-SB11	—		
		2	0		100-C*	100-SB20	—		
		1L	1L		100-C*	100-SBL11	—		











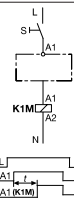
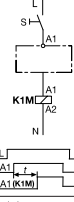

* Max. number of auxiliary contacts that may be mounted:

AC and 24V DC electronic coil contactors — max. 4 N.O. contacts on the front of the contactor, 2 N.O. contacts on the side, 4 N.C. front or side, 6 total.
 DC coil contactors — max. 4 N.O. contacts on the front of the contactor or max 2 N.O. contacts on the side, 4 N.C. front or side, 4 total.

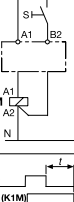
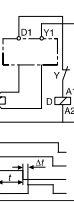
* Double numbering — Left-side mounting only is recommended for **Cat. No. 100-C09...100-C23** due to double numbering.

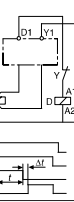
‡ For screwless terminals (front mount only), insert "CR" after the "100-" in the catalog number. Example: **Cat. No. 100-FA02** becomes **Cat. No. 100-CRFA02**.

Control Modules (For 100-C09...C97 contactors)

	Description	Connection Diagrams	For Use With	Cat. No.					
	Pneumatic Timing Modules • Pneumatic timing element contacts switch after the delay time. The contacts on the main control relay continue to operate without delay.	On-Delay 0.3...30 s Range 1.8...180 s Range		100-C or 700-CF with AC or 24V DC electronic coils†	100-FPTA30 100-FPTA180				
		Off-Delay 0.3...30 s Range 1.8...180 s Range			100-C all, 700-CF all	100-FPTB30 100-FPTB180			
			Electronic Timing Modules — On-Delay Delay of the contactor or control relay solenoid. The contactor or control relay is energized at the end of the delay time.		0.1...3 s Range 1...30 s Range 10...180 s Range		100-C or 700-CF with 110...240V, 50/60 Hz or 110...250V DC coils	100-ETA3 100-ETA30 100-ETA180	
				0.1...3 s Range 1...30 s Range 10...180 s Range				100-C or 700-CF with 24...48V DC coils	100-ETAZJ3 100-ETAZJ30 100-ETAZJ180
	Electronic Timing Modules — Off-Delay Delay of the contactor or control relay solenoid. After interruption of the control signal, the contactor or control relay is deenergized at the end of the delay time.			0.3...3 s Range 1...30 s Range 10...180 s Range			100-C09...C37 or 700-CF with 24V 50/60 Hz coils		100-ETBKJ3 100-ETBKJ30 100-ETBKJ180
				0.3...3 s Range 1...30 s Range 10...180 s Range				100-C or 700-CF with 110...240V 50/60 Hz coils	100-ETB3 100-ETB30 100-ETB180
		0.3...3 s Range 1...30 s Range 10...180 s Range		100-C with 110...240V, 50/60 Hz coils					100-ETY30
						Mechanical Interlocks • For interlocking of two contactors. • Common interlock for all Bul. 100-C contactor sizes • Interlocking of different sizes possible • Mechanical and electrical interlocking possible in one module by means of integrated auxiliary contacts • 9 mm dovetail connector included	Mechanical only, without auxiliary contacts		
					Mechanical/electrical interlock with 2 N.C. auxiliary contacts			100-C (except 100-C40, -C90)	
			Mechanical Latch • Following contactor latching, the contactor coil is immediately de-energized (off) by the N.C. auxiliary contact (65-66). • Electrical or manual release • 1 N.O. + 1 N.C. auxiliary contacts • Suitable for all Bul. 100-C contactor sizes, 9...97 A	Maximum command duration 0.03...10 s		100-C with AC or 24V DC electronic coils (except 100-C90)		100-FL11⊗	

† Cannot be used with side-mounted auxiliary contacts on 700-CF DC relays.

⊗ **Coil Voltage Code**



The cat. no. as listed is incomplete. Select a voltage suffix code from the table below to complete the cat. no. Example: 120V, 60 Hz: **Cat. No. 100-FL11⊗** becomes **Cat. No. 100-FL11D**.

Voltage* [V]	24	48	100	110	120	230...240	240	277	380...400	400...415	440	480
50 Hz	K	Y	KP	D	—	VA	KA	—	N	G	B	—
60 Hz	J	—	—	—	D	—	KA	T	—	—	N	B

* For special voltages, consult your local Rockwell Automation sales office or Allen-Bradley distributor.



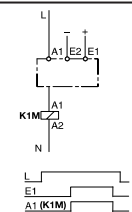

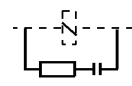
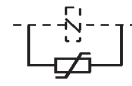
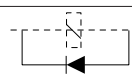

Control Modules (For 100-C09...C97 contactors), Continued

	Description	Voltage Range	Connection Diagrams	For Use With	Cat. No.	
	DC Interface (Electronic) • Interface between the DC control signal (PLC) and the AC operating mechanism of the contactor. • Requires no additional surge suppression on the relay coils	Input: 12V DC Output: 110...240V AC		100-C with AC coils 110...240V AC	100-JE12	
		Input: 18...30V DC Output: 110...240V AC			100-JE	
		Input: 48V DC Output: 110...240V AC			100-JE48	
	Surge Suppressors • For limitation of coil switching transients. • Plug-in, coil mounted. • Suitable for 100-C contactor sizes, 9...97 A. • RC, varistor, and diode versions.	24...48V AC, 50/60 Hz		100-C with AC coils	‡ 100-FSC48	
		110...280V AC, 50/60 Hz			‡ 100-FSC280	
		380...480V AC, 50/60 Hz			‡ 100-FSC480	
		Varistor Module AC/DC operating mechanism	12...55V AC/ 12...77V DC		100-C with AC coils or 100-C09...-C43 with DC coils	‡ 100-FSV55
			56...136V AC/ 78...180V DC			‡ 100-FSV136
			137...277V AC/ 181...350V DC			‡ 100-FSV277
			278...575V AC			‡ 100-FSV575
		Diode Module DC operating mechanism	12...250V DC		100-C09...-C43 with DC coils	‡ 100-FSD250

‡ For screwless terminals, insert "CR" after the "100-" in the catalog number. Example: **Cat. No. 100-FSC48** becomes **Cat. No. 100-CR-FSC48**.

Assembly Components (For 100-C09...C97 contactors)

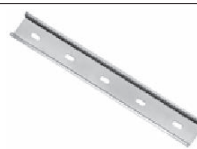
	Description	For Use With	Pkg. Quantity	Cat. No.
 Cat. No. 100-S0	Dovetail Connectors • For use in contactor and starter assemblies. • Single Connector — 0 mm Spacing	100-C	10	100-S0
	Dovetail Connectors • For use in contactor and starter assemblies. • Dual Connector — 9 mm Spacing			100-S9
 Cat. No. 100-SCCA	Protective Covers • Provides protection against unintended manual operation • For contactors and front-mounted auxiliary contacts, pneumatic timers, and latches	100-C all	1	100-SCCA
 Cat. No. 100-SCFA		100-FA, -FB, -FC, -FP, -FL;	10	100-SCFA
 Cat. No. 105-PW23	Reversing Power Wiring Kits • For reversing connection with a solid-state or thermal overload relay	100-C09...C23	1	105-PW23
		100-C30...C37	1	105-PW37
		100-C43	1	105-PW43
		100-C60...C97	1	105-PW85
	DIN (#3) symmetrical hat rail 35 x 7.5 x 1 m	140M-D 140M-F 100-C all	10	199-DR1

Wye-Delta/Star-Delta Starter Kits

Wye-Delta power wiring kits were designed to aid in the field assembly of open-transition wye-delta starters that use Bulletin 100-C contactors. These kits include line, load, and start-point (shorting) connections. Assembling a wye-delta starter requires the use of the following additional components:

- Contactors
- Overload Relay
- Cat. No. 100-MCA02 Mechanical/Electrical Interlock
- Cat. No. 100-ETY30 Electronic Y-Δ Timer
- Cat. No. 100-S9 Base Coupler for 1M to 2M contactor (optional)

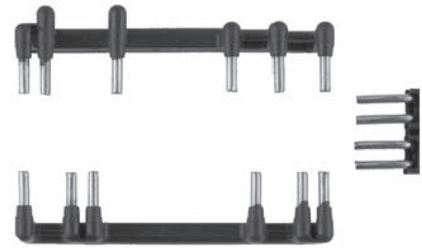



Cat. No. 170-PW23

3-Phase Rating											Pkg. Qty.	Cat. No.
kW (50 Hz)				Hp (60 Hz)				Use with Cat. No. 100-				
230V	380/415V	500V	690V	200V	230V	460V	575V	Delta	Wye			
								1M	2M	1S		
5.5	8	8	8	5	5	10	10	C09	C09	C09	1	170-PW23
7.5	11	11	11	5	7.5	15	15	C12	C12	C09	1	170-PW23
10	14	15	14	7.5	10	20	20	C16	C16	C12	1	170-PW23
14	21	21	19	7.5	10	25	25	C23	C23	C12	1	170-PW23
18	28	28	28	10	15	30	30	C30	C30	C16	1	170-PW37
19	35	35	32	15	20	40	40	C37	C37	C23	1	170-PW37
23	40	40	41	20	25	50	50	C43	C43	C30	1	170-PW43
33	58	60	56	30	40	75	75	C60	C60	C37	1	170-PW72
39	69	67	70	40	50	100	100	C72	C72	C43	1	170-PW72
47	82	82	81	50	60	125	125	C85	C85	C60	1	170-PW85
50	90	90	90	50	60	125	125	C97	C97	C60	1	170-PW85





Package Quantity = 1

Marking Systems (For 100-C09...C97 contactors)

	Description	Pkg. Qty.*	Cat. No.
	Label Sheet 105 self-adhesive paper labels each, 6 x 17 mm	10	100-FMS
	Marking Tag Sheet 160 perforated paper labels each, 6 x 17 mm, to be used with a transparent cover	10	100-FMP
	Transparent Cover To be used with marking tag sheets	100	100-FMC
	Marking Tag Adapters To be used with marking tag: System V4/V5	100	100-FMA1
	Marking Tag Adapters To be used with marking tag: System 1492 W	100	100-FMA2

* Must be ordered in multiples of package quantities.

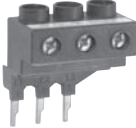
Terminal Kits (For 100-C09...C97 contactors)

	Description	Max. Current Ratings and Wire Sizes	Pkg. Qty.*	Cat. No.
	Stab Connector Kit Dual stab (0.250 in.) for 100-C coil terminals For 100-C09...C97 contactors		20	199-SC2
	Stab Connector Kit Dual stab (0.250 in.) for 100-C power terminals For 100-C09...C23 contactors		100	199-SC10
	3-Pole Terminal Lug Kit For Cat. No. 100-C09...C23 (Line side)	IEC @ 40 °C IEC @ 40 °C UL/CSA (Encl.)	45 A (4...16 mm ² *, fine stranded w/ ferrule) 45 A (4...25 mm ² , coarse stranded/solid) 40 A (#10...4 AWG, stranded/solid)	1 100-CTN23
	3-Pole Terminal Lug Kit For Cat. No. 100-C09...C23 (Load side)	IEC @ 40 °C IEC @ 40 °C UL/CSA (Encl.)	45 A (4...16 mm ² *, fine stranded w/ ferrule) 45 A (4...25 mm ² , coarse stranded/solid) 40 A (#10...4 AWG, stranded/solid)	1 100-CTL23
	3-Pole Terminal Lug Kit For Cat. No. 100-C30...C37 (Line and load side)	IEC @ 40 °C IEC @ 40 °C UL/CSA (Encl.)	60 A (4...16 mm ² *, fine stranded w/ ferrule) 60 A (4...25 mm ² , coarse stranded/solid) 55 A (#10...4 AWG, stranded/solid)	1 100-CT37
	1-Pole Terminal Lug Kit For Cat. No. 100-C43	IEC @ 40 °C IEC @ 40 °C UL/CSA (Encl.)	90 A (6...35 mm ² , fine stranded w/ ferrule) 90 A (6...50 mm ² , coarse stranded/solid) 75 A (#8...2 AWG, stranded/solid)	3 100-CT43
	1-Pole Terminal Lug Kit For Cat. No. 100-C60...C97	IEC @ 40 °C IEC @ 40 °C UL/CSA (Encl.)	130 A (10...70 mm ² , fine stranded w/ ferrule) 130 A (10...95 mm ² , coarse stranded/solid) 130 A (#8...2/0 AWG, stranded/solid)	3 100-CT85
	3-Pole Paralleling Kit For Cat. No. 100-C09...C23	IEC @ 40 °C IEC @ 40 °C UL/CSA (Encl.)	100 A (35...70 mm ² , fine stranded w/ ferrule) 100 A (35...95 mm ² , coarse stranded/solid) 100 A (#0...2/0 AWG, stranded/solid)	2 100-CP23
	3-Pole Paralleling Kit For Cat. No. 100-C30...C37	IEC @ 40 °C IEC @ 40 °C UL/CSA (Encl.)	150 A (35...70 mm ² , fine stranded w/ ferrule) 150 A (35...95 mm ² , coarse stranded/solid) 150 A (#0...2/0 AWG, stranded/solid)	2 100-CP37

* Must be ordered in multiples of the package quantity.

* 16 mm² max. according to IEC 60947; actual max. 25 mm².

SEMI-F47 Voltage Sag Immunity Module

	Description	Input Voltage	For Use With‡	Options	Cat. No.
	SEMI-F47 Module <ul style="list-style-type: none"> Meets SEMI-F47 voltage sag immunity requirements Direct mounting to coil terminals of 100-C contactors and 700-CF control relays Requires DC coil contactor Optional 1...30 s ON-delay timer version 	24...240V AC	100-C09...C97 700-CF	without timer	100-CSF47
		110...240V AC	100-C09...C97 700-CF	with 1...30 s ON-delay timer	100-CSF47A30

‡ Contactor must have DC coil at the same voltage as AC input. Example: for 24V AC control, select **Cat. No. 100-C09ZJ10** (24V DC coil).

IEC Contactors

Specifications

2

Coil Type :	Conventional Electronic — EI	100-KR		100/104-K			100/104-C, 100S/104S-C									
		05	09	05	09	12	09	12	16	23	30	37	40*200	40*400	43	60
		X	X	X	X	X	X	X	X	X	X	X	X	X	X	X
		—	—	—	—	—	—	—	—	—	—	—	—	—	—	—

**AC-1 Active Power Load (50 Hz);
Ambient temperature 40 °C**

<i>I_e</i>	≤ 500V	[A]	10	10	20	20	20	32	32	32	32 (40)*	65	65	75	75	85	100
	690V	[A]	10	10	20	20	20	32	32	32	32 (40)*	65	65	75	75	85	100
	1000V	[A]	—	—	—	—	—	—	—	—	—	—	—	—	—	—	—
	230V	[kW]	4	4	8	8	8	13	13	13	13	26	26	30	30	34	40
	240V	[kW]	4	4	8.3	8.3	8.3	13	13	13	13	27	27	31	31	35	42
	400V	[kW]	6.9	6.9	14	14	14	22	22	22	22	45	45	52	52	59	69
	415V	[kW]	7	7	14	14	14	23	23	23	23	47	47	54	54	61	72
	500V	[kW]	8.7	8.7	17	17	17	28	28	28	28	56	56	65	65	74	87
	690V	[kW]	12	12	24	24	24	38	38	38	38	78	78	90	90	102	120
	1000V	[kW]	—	—	—	—	—	—	—	—	—	—	—	—	—	—	—

Ambient temperature 60 °C

<i>I_e</i>	≤ 500V	[A]	10	10	16	16	16	32	32	32	32	65	65	60	60	80	100
	690V	[A]	10	10	16	16	16	32	32	32	32	65	65	60	60	80	100
	1000V	[A]	—	—	—	—	—	—	—	—	—	—	—	—	—	—	—
	230V	[kW]	4	4	6.4	6.4	6.4	13	13	13	13	26	26	24	24	25	40
	240V	[kW]	4	4	6.7	6.7	6.7	13	13	13	13	27	27	25	25	26	42
	400V	[kW]	6.9	6.9	11	11	11	22	22	22	22	45	45	42	42	44	69
	415V	[kW]	7	7	12	12	12	23	23	23	23	47	47	43	43	45	72
	500V	[kW]	8.7	8.7	14	14	14	28	28	28	28	56	56	52	52	55	87
	690V	[kW]	12	12	19	19	19	38	38	38	38	78	78	72	72	75	120
	1000V	[kW]	—	—	—	—	—	—	—	—	—	—	—	—	—	—	—

Switching of 3-phase Motors; (50 Hz)

Ambient temperature 60 °C, AC-2, AC-3

	230V	[A]	6.3	8.5	6.3	11.3	11.3	12	15	20	26.5	35	38	38	38	44	62
	240V	[A]	6.3	8.5	6.3	11.3	11.3	12	15	20	26.5	35	38	38	38	44	62
	400V	[A]	4.9	8.5	4.9	8.5	11.5	9	12	16	23	30	37	37	37	43	60
	415V	[A]	4.9	8.5	4.9	8.5	11.5	9	12	16	23	30	37	37	37	43	60
	500V	[A]	3.9	6.8	3.9	6.8	9.2	7	10	14	20	25	30	29	30	38	55
	690V	[A]	2.8	4.9	2.8	4.9	6.7	5	7	9	12	18	21	9	21	25	34
	1000V	[A]	—	—	—	—	—	—	—	—	—	—	—	—	—	—	—
	230V	[kW]	1.5	2.2	1.5	3	3	3	4	5.5	7.5	10	11	11	11	13	18.5
	240V	[kW]	1.5	2.2	1.5	3	3	3	4	5.5	7.5	10	11	11	11	13	18.5
	400V	[kW]	2.2	4	2.2	4	5.5	4	5.5	7.5	11	15	18.5	18.5	18.5	22	32
	415V	[kW]	2.2	4	2.2	4	5.5	4	5.5	7.5	11	15	20	20	20	22	32
	500V	[kW]	2.2	4	2.2	4	5.5	4	5.5	7.5	13	15	20	18.5	20	25	37
	690V	[kW]	2.2	4	2.2	4	5.5	4	5.5	7.5	10	15	18.5	7.5	18.5	22	32
	1000V	[kW]	—	—	—	—	—	—	—	—	—	—	—	—	—	—	—

Load Carrying Capacity per UL/CSA

General Purpose Current (enclosed)

	[A]	9	9	12	15	18	25	25	30	30	55	60	60	60	75	90
--	-----	---	---	----	----	----	----	----	----	----	----	----	----	----	----	----

Rated power (enclosed)

1-phase	115V	[A]	7.2	7.2	9.8	9.8	13.8	9.8	9.8	16	24	24	34	34	34	34	56
	230V	[A]	6.9	8	8	10	12	10	12	17	17	28	28	28	28	40	50
	115V	[Hp]	1/3	1/3	0.5	0.5	0.75	0.5	0.5	1	2	2	3	3	3	3	5
	230V	[Hp]	3/4	1	1	1.5	2	1.5	2	3	3	5	5	5	5	7.5	10
3-phase	200V	[A]	6.9	7.8	6.9	7.8	11	7.8	11	17.5	17.5	25.3	32.2	32.2	32.2	32.2	48.3
	230V	[A]	6	6.8	6	6.8	9.6	6.8	9.6	15.2	22	28	28	28	28	42	54
	460V	[A]	4.8	7.6	4.8	7.6	11	7.6	11	14	21	27	34	34	34	40	52
	575V	[A]	3.9	6.1	3.9	6.1	9	9	11	17	17	27	32	17	32	32	52
	200V	[Hp]	1.5	2	1.5	2	3	2	3	5	5	7.5	10	10	10	10	15
	230V	[Hp]	1.5	2	1.5	2	3	2	3	5	5	7.5	10	10	10	10	15
	460V	[Hp]	3	5	3	5	7.5	5	7.5	10	15	20	25	25	25	30	40
575V	[Hp]	3	5	3	5	7.5	7.5	10	15	15	25	30	15	30	30	50	



100/104-C, 100S/104S-C					100/104-D, 100S-D										
72	85	90*200	90*400	97	115	140	140	180	180	210	250	300	420	630	860
X	X	X	X	X	X	X	—	X	—	—	—	—	—	—	—
—	—	—	—	—	X	—	X	—	X	X	X	X	X	X	X
AC-1 Active Power Load (50 Hz); Ambient temperature 40 °C															
100	100	130	130	130	250	250	250	250	250	350	350	450	540	800	1000
100	100	130	130	130	250	250	250	250	250	350	350	450	540	800	1000
—	—	—	—	—	250	250	250	250	250	350	350	450	540	—	—
40	40	52	52	52	100	100	100	100	100	139	139	179	199	319	398
42	42	54	54	54	104	104	104	104	104	145	145	187	208	333	416
69	69	90	90	90	173	173	173	173	173	242	242	312	346	554	693
72	72	93	93	93	180	180	180	180	180	252	252	323	359	575	719
87	87	113	113	113	217	217	217	217	217	303	303	390	433	693	866
120	120	155	155	155	299	299	299	299	299	418	418	538	598	956	1195
—	—	—	—	—	433	433	433	433	433	606	606	779	866	—	—
Ambient temperature 60 °C															
100	100	110	110	110	210	210	210	210	210	300	300	380	425	—	—
100	100	110	110	110	210	210	210	210	210	300	300	380	425	—	—
—	—	—	—	—	210	210	210	210	210	300	300	380	425	—	—
40	40	44	44	44	84	84	84	84	84	120	120	151	169	—	—
42	42	46	46	46	87	87	87	87	87	125	125	158	177	—	—
69	69	76	76	76	145	145	145	145	145	208	208	263	294	—	—
72	72	79	79	79	151	151	151	151	151	216	216	273	305	—	—
87	87	95	95	95	182	182	182	182	182	260	260	329	368	—	—
120	120	131	131	131	251	251	251	251	251	359	359	454	508	—	—
—	—	—	—	—	364	364	364	364	364	520	520	658	736	—	—
Switching of 3-phase Motors; (50 Hz) Ambient temperature 60 °C, AC-2, AC-3															
72	85	85	85	96	115	140	140	180	180	210	250	300	420	630	860
72	85	85	85	95	115	140	140	180	180	210	250	300	420	630	860
72	85	85	85	97	115	140	140	180	180	210	250	300	420	630	860
72	85	85	85	97	115 (130)‡	140 (155)‡	140 (155)‡	180 (189)‡	180 (189)‡	210 (227)‡	250 (258)‡	300 (315)‡	420	630	860
67	80	80	80	78	115	115	140	140	180	210	250	300	420	630	753
42	49	22	49	57	115	115	140	140	180	210	250	300	420	492	—
—	—	—	—	—	46	55	55	65	65	80	95	115	160	—	—
22	25	25	25	30	37	45	45	57	57	67	80	97	135	200	250
22	25	25	25	30	38	47	47	60	60	70	83	101	141	200	250
40	45	45	45	55	64	78	78	101	101	118	140	170	238	355	500
40	45	45	45	55	66 (75)‡	82 (90)‡	82 (90)‡	105 (110)‡	105 (110)‡	122 (132)‡	145 (150)‡	176 (185)‡	250	355	500
45	55	55	55	55	80	80	98	98	126	147	177	213	298	450	560
40	45	18.5	45	55	111	111	135	135	176	205	250	293	424	500	—
—	—	—	—	—	63	75	75	90	90	110	132	160	225	—	—
Load Carrying Capacity per UL/CSA															
General Purpose Current (enclosed)															
90	100	125	130	120	160	220	220	220	220	300	300	340	420	630	860
Rated power (enclosed)															
56	80	80	80	100	100	135	135	—	—	—	—	—	—	—	—
68	68	68	68	88	110	136	136	176	176	216	—	—	—	—	—
5	7.5	7.5	7.5	10	10	15	15	—	—	—	—	—	—	—	—
15	15	15	15	20	25	30	30	40	40	50	—	—	—	—	—
62.1	78.2	78.2	78.2	92	120	120	120	150	150	177	221	285	414	552	692
68	80	80	80	80	104	130	130	154	154	192	248	312	420	602	720
65	77	65	77	96	96	124	124	180	180	180	240	302	414	590	702
62	62	22	52	77	99	125	125	144	144	192	242	289	382	562	651
20	25	25	25	30	40	40	40	50	50	60	75	100	150	200	250
25	30	30	30	30	40	50	50	60	60	75	100	125	175	250	300
50	60	50	60	75	75	100	100	150	150	150	200	250	350	500	600
60	60	20	50	75	100	125	125	150	150	200	250	300	400	600	700

‡ 415 V: values in () AC-2 and AC-3 lifespan -25 %

IEC Contactors

Specifications

2

		100/104-K			100/104-C, 100S/104S-C								
		05	09	12	09	12	16	23	30	37	43	60	
Coil Type :	Conventional	X	X	X	X	X	X	X	X	X	X	X	X
	Electronic — EI	—	—	—	—	—	—	—	—	—	—	—	—
Switching of 3-phase Motors, (50Hz); Ambient temperature 60 °C, AC-4													
	230V [A]	6.3	11.3	11.3	12	15	20	26.5	35	38	44	62	
	240V [A]	6.3	11.3	11.3	12	15	20	26.5	35	38	44	62	
	400V [A]	4.9	8.5	11.5	9	12	16	23	30	37	43	60	
	415V [A]	4.9	8.5	11.5	9	12	16	23	30	37	43	60	
	500V [A]	3.9	6.8	9.2	7	10	14	20	25	30	38	55	
	690V [A]	2.8	4.9	6.7	5	7	9	12	18	21	25	34	
	1000V [A]	—	—	—	—	—	—	—	—	—	—	—	
	230V [kW]	1.5	3	3	3	4	5.5	7.5	10	11	13	18.5	
	240V [kW]	1.5	3	3	3	4	5.5	7.5	10	11	13	18.5	
	400V [kW]	2.2	4	5.5	4	5.5	7.5	11	15	18.5	22	32	
	415V [kW]	2.2	4	5.5	4	5.5	7.5	11	15	20	22	32	
	500V [kW]	2.2	4	5.5	4	5.5	7.5	13	15	20	25	37	
	690V [kW]	2.2	4	5.5	4	5.5	7.5	10	15	18.5	22	32	
	1000V [kW]	—	—	—	—	—	—	—	—	—	—	—	
AC-4 at approximately 200,000 operations													
	230V [A]	2.3	3.9	3.9	4.3	6.6	9	9	12	14	16.5	25.5	
	240V [A]	2.3	3.9	3.9	4.3	6.6	9	9	12	14	16.5	25.5	
	400/415V [A]	2	3.6	3.6	4.3	6.6	9	9	12	14	16.5	25.5	
	500V [A]	1.9	3.2	3.2	4.3	6.6	9	9	12	14	16.5	25.5	
	690V [A]	—	—	—	4.3	6.6	9	9	12	14	16.5	25.5	
	1000V [A]	—	—	—	—	—	—	—	—	—	—	—	
	230V* [kW]	0.37	0.75	0.75	0.75	1.5	2.2	2.2	3	3.7	4	6.3	
	240V* [kW]	0.37	0.75	0.75	0.75	1.5	2.2	2.2	3	4	4	7.5	
	400V* [kW]	0.75	1.5	1.5	1.8	3	4	4	5.5	6.3	7.5	13	
	415V* [kW]	0.75	1.5	1.5	1.8	3	4	4	5.5	6.3	7.5	13	
	500V* [kW]	0.75	1.5	1.5	2.2	3.7	5.5	5.5	7.5	7.5	10	15	
	690V* [kW]	—	—	—	3	5.5	7.5	7.5	10	11	15	22	
	1000V* [kW]	—	—	—	—	—	—	—	—	—	—	—	
Max. switching frequency	Ops/h	250	250	250	250	250	220	200	200	200	200	120	
Wye-Delta (60 Hz)													
	200V [Hp]	2.2	3	5	5	5	7½	7½	10	15	20	30	
	230V [Hp]	2.2	3	5	5	7½	10	10	15	20	25	40	
	460V [Hp]	5	7.5	10	10	15	20	25	30	40	50	75	
	575V [Hp]	5	7.5	10	10	15	20	25	30	40	50	75	
UL/CSA Elevator Duty†													
	200V [A]	—	—	—	7.8	11.0	11.0	17.5	25.3	25.3	32.2	32.2	
	230V [A]	—	—	—	6.8	9.6	15.2	15.2	22.0	28.0	28.0	42.0	
	460V [A]	—	—	—	7.6	11.0	14.0	21.0	27.0	27.0	34.0	40.0	
	575V [A]	—	—	—	6.1	9.0	11.0	17.0	22.0	27.0	32.0	41.0	
	200V [Hp]	—	—	—	2	3	3	5	7½	7½	10	10	
	230V [Hp]	—	—	—	2	3	5	5	7½	10	10	15	
	460V [Hp]	—	—	—	5	7½	10	15	20	20	25	30	
	575V [Hp]	—	—	—	5	7½	10	15	20	25	30	40	
Star-Delta Starting (50 Hz)													
	≤ 230V [A]	11.3	20	20	21	26	35	46	61	66	76	107	
	≤ 240V [A]	11.3	20	20	21	26	35	46	61	66	76	107	
	400V [A]	8.5	15.5	15.5	16	21	28	40	52	64	74	104	
	415V [A]	8.5	15.5	15.5	16	21	28	40	52	64	74	104	
	500V [A]	6.8	12.4	12.4	12	17	24	35	43	52	66	95	
	690V [A]	4.9	8.9	8.9	8.6	12	16	21	31	36	43	59	
	1000V [A]	—	—	—	—	—	—	—	—	—	—	—	
	230V* [kW]	3	5.5	5.5	5.5	7.5	10	13	17	20	22	32	
	240V* [kW]	3	5.5	5.5	5.5	7.5	10	13	18.5	20	22	32	
	400V* [kW]	4	7.5	10	7.5	10	13	20	25	32	40	55	
	415V* [kW]	4	7.5	11	7.5	11	15	22	25	37	40	55	
	500V* [kW]	4	7.5	7.5	7.5	11	15	22	25	32	45	63	
	690V* [kW]	4	7.5	7.5	7.5	10	13	18.5	25	32	40	55	
	1000V* [kW]	—	—	—	—	—	—	—	—	—	—	—	

* Power ratings at 50 Hz: Preferred values according to IEC 60072-1

† Approval pending on Cat. No. 100-D210...D860.



100/104-C, 100S/104S-C			100/104-D, 100S-D										
72	85	97	115	140	140	180	180	210	250	300	420	630	860
X	X	X	X	X	—	X	—	—	—	—	—	—	—
—	—	—	X	—	X	—	X	X	X	X	X	X	X
Switching of 3-phase Motors, (50 Hz); Ambient temperature 60 °C, AC-4													
72	85	96	115	140	140	180	180	210	250	300	420	—	—
72	85	95	115	140	140	180	180	210	250	300	420	—	—
72	85	97	115	140	140	180	180	210	250	300	420	—	—
72	85	97	115 (130)*	140 (155)*	140 (155)*	180 (189)‡	180 (189)‡	210 (227)*	250 (258)*	300 (315)*	420	—	—
67	80	78	115	115	140	140	170	210	250	300	360	—	—
42	49	57	115	115	140	140	170	210	250	300	360	—	—
—	—	—	46	55	55	65	65	80	95	115	160	—	—
22	25	30	37	45	45	57	57	67	80	97	135	—	—
22	25	30	39	47	47	60	60	70	83	101	141	—	—
40	45	55	63	78	78	100	100	118	140	170	238	—	—
40	45	55	66 (75)*	82 (90)*	82 (90)*	105 (110)*	105 (110)*	125 (132)*	145 (150)*	176 (185)*	250	—	—
45	55	55	80	80	98	98	119	147	177	213	255	—	—
40	45	55	110	110	135	135	167	205	250	293	356	—	—
—	—	—	63	75	75	90	90	110	132	160	225	—	—
AC-4 at approximately 200,000 operations													
31	38	44	53	60	60	67	67	85	105	140	170	—	—
31	38	44	53	60	60	67	67	85	105	140	170	—	—
31	38	44	53	60	60	67	67	85	105	140	170	—	—
31	38	44	53	60	60	67	67	85	105	140	170	—	—
31	38	44	53	60	60	67	67	85	105	140	170	—	—
—	—	—	25	37	37	43	43	60	72	85	105	—	—
7.5	11	11	15	17	17	20	20	25	32	45	55	—	—
7.5	11	11	15	18.5	18.5	22	22	25	32	45	55	—	—
15	20	22	25	32	32	37	37	45	55	75	90	—	—
17	20	22	25	32	32	37	37	50	55	80	100	—	—
20	25	30	32	40	40	45	45	55	75	100	110	—	—
25	32	37	45	55	55	63	63	80	100	132	160	—	—
—	—	—	30	50	50	55	55	80	100	110	150	—	—
120	120	120	120	120	120	100	100	120	100	70	70	—	—
Wye-Delta (60 Hz)													
40	50	50	60	60	60	75	75	100	125	175	250	—	—
50	60	60	60	75	75	100	100	125	175	200	250	—	—
100	125	125	125	175	175	200	200	250	350	450	600	—	—
100	125	125	150	200	200	250	250	300	450	500	650	—	—
UL/CSA Elevator Duty‡													
48.3	62.1	TBD	78	92	92	120	120	150	150	177	221	—	—
54.0	68.0	TBD	80	104	104	130	130	130	154	192	248	—	—
52.0	65.0	TBD	77	96	96	124	124	156	180	180	240	—	—
52.0	62.0	TBD	77	77	77	99	99	125	144	192	242	—	—
15	20	TBD	25	30	30	40	40	50	50	60	75	—	—
20	25	TBD	30	40	40	50	50	50	60	75	100	—	—
40	50	TBD	60	75	75	100	100	125	150	150	200	—	—
50	60	TBD	75	75	75	100	100	125	150	200	250	—	—
Star-Delta Starting (50 Hz)													
125	147	166	199	242	242	312	312	364	433	520	727	—	—
125	147	165	199	242	242	312	312	364	433	520	727	—	—
125	147	168	199	242	242	312	312	364	433	520	727	—	—
125	147	168	199 (225)*	242 (268)*	242 (268)*	312 (332)*	312 (332)*	364 (393)*	433 (447)*	520 (546)*	727	—	—
116	139	135	199	199	242	312	312	364	433	520	727	—	—
73	85	99	199	199	242	312	312	364	433	520	727	—	—
—	—	—	80	95	95	113	113	139	165	200	277	—	—
37	45	50	63	75	75	90	90	110	132	160	220	—	—
40	50	50	66	80	80	100	100	125	150	160	250	—	—
63	80	90	110	132	132	160	160	200	250	300	425	—	—
63	80	90	114 (132)*	132 (160)*	132 (160)*	160	160	220	250	315 (335)*	425	—	—
80	90	90	132	132	160	200	200	250	315	375	530	—	—
63	80	90	192	200	220	300	300	355	425	530	750	—	—
—	—	—	110	132	132	160	160	200	220	280	400	—	—

* 415V: Values in () AC-3 and AC-4 lifespan -25%

‡ Approval pending on Cat. No. 100-D210...D860.

IEC Contactors

Specifications

2

Conventional Coil Type : Electronic — EI	100/104-K			100/104-C, 100S/104S-C							
	05	09	12	09	12	16	23	30	37	43	60
	X	X	X	X	X	X	X	X	X	X	X
	—	—	—	—	—	—	—	—	—	—	—

Switching of Power Transformers, AC-6a (50 Hz)

Inrush Current

Rated transformer current = n

Rated transformer current		05	09	12	09	12	16	23	30	37	43	60
n = 30	≤ 230V [A]	2.9	5.4	5.4	10.9	10.9	10.9	10.9	20	20	23	40.8
	≤ 240V [A]	2.9	5.4	5.4	10.9	10.9	10.9	10.9	20	20	23	40.8
	≤ 400V [A]	2.4	4.1	5.4	10.9	10.9	10.9	10.9	20	20	23	40.8
	≤ 415V [A]	2.4	4.1	5.4	10.9	10.9	10.9	10.9	20	20	23	40.8
	≤ 500V [A]	1.8	3.2	3.2	10.9	10.9	10.9	10.9	20	20	23	40.8
	≤ 690V [A]	—	—	—	10.9	10.9	10.9	10.9	20	20	23	40.8
	≤ 1000V [A]	—	—	—	—	—	—	—	—	—	—	—
	230V [kVA]	1.2	2	2	4.3	4.3	4.3	4.3	8	8	9.2	16
	240V [kVA]	1.2	2	2	4.5	4.5	4.5	4.5	8.3	8.3	10	17
	400V [kVA]	1.7	2.8	3.4	7.5	7.5	7.5	7.5	14	14	16	28
415V [kVA]	1.7	2.8	3.4	7.8	7.8	7.8	7.8	14	14	17	29	
500V [kVA]	1.7	2.8	3.4	9.4	9.4	9.4	9.4	17	17	20	35	
690V [kVA]	2	4	5	13	13	13	13	24	24	27	49	
1000V [kVA]	—	—	—	—	—	—	—	—	—	—	—	
n = 20	≤ 690V [A]	—	—	—	16.3	16.3	16.3	16.3	30	30	34.5	61.3
n = 15	≤ 690V [A]	—	—	—	22	22	22	22	40	40	46	82

60 Hz Peak Inrush/peak rated transformer current

n = 30 [A]	—	—	—	10.9	10.9	10.9	10.9	20	20	23	40.8
200V [kVA]	—	—	—	3.8	3.8	3.8	3.8	6.9	6.9	8.0	14.1
208V [kVA]	—	—	—	3.9	3.9	3.9	3.9	7.2	7.2	8.3	14.7
240V [kVA]	—	—	—	4.5	4.5	4.5	4.5	8.3	8.3	9.6	17.0
480V [kVA]	—	—	—	9.1	9.1	9.1	9.1	16.6	16.6	19.1	33.9
600V [kVA]	—	—	—	11.3	11.3	11.3	11.3	20.8	20.8	23.9	42.4
660V [kVA]	—	—	—	12.5	12.5	12.5	12.5	22.9	22.9	26.3	46.6

60 Hz Peak Inrush/peak rated transformer current

n = 20 [A]	—	—	—	16.3	16.3	16.3	16.3	30	30	34.5	61.3
200V [kVA]	—	—	—	5.6	5.6	5.6	5.6	10.4	10.4	12.0	21.2
208V [kVA]	—	—	—	5.9	5.9	5.9	5.9	10.8	10.8	12.4	22.1
240V [kVA]	—	—	—	6.8	6.8	6.8	6.8	12.5	12.5	14.3	25.5
480V [kVA]	—	—	—	13.6	13.6	13.6	13.6	24.9	24.9	28.7	51.0
600V [kVA]	—	—	—	16.9	16.9	16.9	16.9	31.2	31.2	35.9	63.7
660V [kVA]	—	—	—	18.6	18.6	18.6	18.6	34.3	34.3	39.4	70.1

60 Hz Peak Inrush/peak rated transformer current

n=15 [A]	—	—	—	22	22	22	22	40	40	46	82
200V [kVA]	—	—	—	7.5	7.5	7.5	7.5	13.9	13.9	15.9	28.4
208V [kVA]	—	—	—	7.8	7.8	7.8	7.8	14.4	14.4	16.6	29.5
240V [kVA]	—	—	—	9.0	9.0	9.0	9.0	16.6	16.6	19.1	34.1
480V [kVA]	—	—	—	18.1	18.1	18.1	18.1	33.3	33.3	38.2	68.2
600V [kVA]	—	—	—	22.6	22.6	22.6	22.6	41.6	41.6	47.8	85.2
660V [kVA]	—	—	—	24.9	24.9	24.9	24.9	45.7	45.7	52.6	93.7



100/104-C, 100S/104S-C			100/104-D, 100S-D										
72	85	97	115	140	140	180	180	210	250	300	420	630	860
X	X	X	X	X	—	X	—	—	—	—	—	—	—
—	—	—	X	—	X	—	X	X	X	X	X	X	X

**Switching of Power Transformers,
AC-6a (50 Hz)**

40.8	40.8	48.5	60	70	70	85	85	105	125	150	210	—	—
40.8	40.8	48.5	60	70	70	85	85	105	125	150	210	—	—
40.8	40.8	48.5	60	70	70	85	85	105	125	150	210	—	—
40.8	40.8	48.5	60	70	70	85	85	105	125	150	210	—	—
40.8	40.8	48.5	60	70	70	85	85	105	125	150	210	—	—
—	—	—	46	70	70	85	85	105	125	150	210	—	—
16	16	19.3	24	28	28	34	34	42	50	60	84	—	—
17	17	20.2	26	29	29	35	35	44	52	62	87	—	—
28	28	33.6	42	48	48	59	59	73	87	104	145	—	—
29	29	34.9	43	50	50	61	61	75	90	108	151	—	—
35	35	42	52	61	61	74	74	91	108	130	182	—	—
49	49	58	72	84	84	102	102	125	149	179	251	—	—
—	—	—	80	121	121	147	147	182	217	260	364	—	—
61.3	61.3	72.8	90	105	105	128	128	158	188	225	315	—	—
82	82	97	120	140	140	170	170	210	250	300	420	—	—

60 Hz Peak Inrush/peak rated transformer current

40.8	40.8	48.5	60	70	70	85	85	105	125	150	210	—	—
14.4	14.4	16.8	20.8	24.2	24.2	29.4	29.4	36.4	43.3	52.0	72.7	—	—
14.7	14.7	17.5	21.6	25.2	25.2	30.6	30.6	37.8	45.0	54.0	75.7	—	—
17.0	17.0	20.2	24.9	29.1	29.1	35.3	35.3	43.6	52.0	62.4	87.3	—	—
33.9	33.9	40.3	49.9	58.2	58.2	70.7	70.7	87.3	104	125	175	—	—
42.4	42.4	50.4	62.4	72.7	72.7	88.3	88.3	109	130	156	218	—	—
46.6	46.6	55.4	68.6	80.0	80.0	97.2	97.2	120	143	171	240	—	—

60 Hz Peak Inrush/peak rated transformer current

61.3	61.3	72.8	90	105	105	128	128	158	188	225	315	—	—
21.2	21.2	25.2	31.2	36.4	36.4	44.3	44.3	54.7	65.1	77.9	109	—	—
22.1	22.1	26.2	32.4	37.8	37.8	46.1	46.1	56.9	67.7	81.1	113	—	—
25.5	25.5	30.3	37.4	43.6	43.6	53.2	53.2	65.7	78.2	93.5	131	—	—
51.0	51.0	60.5	74.8	87.3	87.3	106	106	131	156	187	262	—	—
63.7	63.7	75.7	93.5	109	109	133	133	164	195	234	327	—	—
70.1	70.1	83.2	103	120	120	146	146	181	215	257	360	—	—

60 Hz Peak Inrush/peak rated transformer current

82	82	97	120	140	140	170	170	210	250	300	420	—	—
28.4	28.4	33.6	41.6	48.5	48.5	58.9	58.9	72.7	86.6	104	145	—	—
29.5	29.5	34.9	43.2	50.4	50.4	61.2	61.2	75.7	90.1	108	151	—	—
34.1	34.1	40.3	49.9	58.2	58.2	70.7	70.7	87.3	104	125	175	—	—
68.2	68.2	80.6	99.8	116	116	141	141	175	208	249	349	—	—
85.2	85.2	100.8	125	145	145	177	177	218	260	312	436	—	—
93.7	93.7	110.9	137	160	160	194	194	240	286	343	480	—	—

2

IEC Contactors

Specifications

2

		100/104-K			100/104-C, 100S/104S-C									
		05	09	12	09	12	16	23	30	37	40*200	40*400	43	60
Coil Type :	Conventional	X	X	X	X	X	X	X	X	X	X	X	X	X
	Electronic — EI	—	—	—	—	—	—	—	—	—	—	—	—	
Switching of 3-phase Capacitors, AC-6b (50 Hz)*														
Single capacitor 40 °C	230V [kVar]	—	—	—	8	8	8.5	9	14	14	—	—	24	28
	240V [kVar]	—	—	—	8	8	8.5	9	14	14	—	—	25	29
	400V [kVar]	—	—	—	8	8	10	12.5	20	24	—	—	35	48
	415V [kVar]	—	—	—	8	8	10	12.5	20	25	—	—	35	50
	500V [kVar]	—	—	—	8	8	10	12.5	20	25	—	—	35	50
	690V [kVar]	—	—	—	8	8	10	12.5	20	25	—	—	35	50
	1000V [kVar]	—	—	—	—	—	—	—	—	—	—	—	—	—
60 °C	230V [kVar]	—	—	—	8	8	8.5	9	12.5	12.5	—	—	18	28
	240V [kVar]	—	—	—	8	8	8.5	9	12.5	12.5	—	—	18	29
	400V [kVar]	—	—	—	8	8	10	12.5	20	21.5	—	—	30	42
	415V [kVar]	—	—	—	8	8	10	12.5	20	22	—	—	30	42
	500V [kVar]	—	—	—	8	8	10	12.5	20	25	—	—	30	42
	690V [kVar]	—	—	—	8	8	10	12.5	20	25	—	—	30	42
	1000V [kVar]	—	—	—	—	—	—	—	—	—	—	—	—	—
Group capacitors 40 °C	230V [kVar]	—	—	—	5	5	8	9	12.5	14	—	—	20	28
	240V [kVar]	—	—	—	5	5	8	9	12.5	14	—	—	20	29
	400V [kVar]	—	—	—	5	5	8	10	15	20	—	—	25	40
	415V [kVar]	—	—	—	5	5	8	10	15	20	—	—	25	40
	500V [kVar]	—	—	—	5	5	8	10	15	20	—	—	25	40
	690V [kVar]	—	—	—	5	5	8	10	15	20	—	—	25	40
	1000V [kVar]	—	—	—	—	—	—	—	—	—	—	—	—	—
60 °C	230V [kVar]	—	—	—	5	5	8	9	12.5	12.5	—	—	18	28
	240V [kVar]	—	—	—	5	5	8	9	12.5	12.5	—	—	18	29
	400V [kVar]	—	—	—	5	5	8	10	15	20	—	—	25	40
	415V [kVar]	—	—	—	5	5	8	10	15	20	—	—	25	40
	500V [kVar]	—	—	—	5	5	8	10	15	20	—	—	25	40
	690V [kVar]	—	—	—	5	5	8	10	15	20	—	—	25	40
	1000V [kVar]	—	—	—	—	—	—	—	—	—	—	—	—	—
60 Hz Single Capacitor — 40 °C														
	200V [kVar]	—	—	—	5	5	8	9	12.5	14	—	—	20	28
	230V [kVar]	—	—	—	5	5	8	9	12.5	14	—	—	20	29
	460V [kVar]	—	—	—	5	5	8	10	15	20	—	—	25	40
	600V [kVar]	—	—	—	5	5	8	10	15	20	—	—	25	40
60 Hz Group Capacitors — 40 °C														
	200V [kVar]	—	—	—	5	5	8	9	12.5	12.5	—	—	18	28
	230V [kVar]	—	—	—	5	5	8	9	12.5	12.5	—	—	18	29
	460V [kVar]	—	—	—	5	5	8	10	15	20	—	—	25	40
	600V [kVar]	—	—	—	5	5	8	10	15	20	—	—	25	40
Switching of Lamps														
Gas discharge lamps AC-5a, 40 °C	open [A]	18	18	18	22.5	25	28	29	40.5	45	65	65	77	81
	enclosed [A]	14.5	14.5	14.5	22.5	25	28	29	37	41	54	54	57	77
Individually compensated:														
Max. capacitance at expected														
Short-circuit current of	10 kA [μF]	750	750	750	1 000	1 000	1 000	1 000	2 700	2 700	—	—	3 200	4 000
	20 kA [μF]	400	400	400	500	500	500	500	1 350	1 350	—	—	1 600	2 000
	50 kA [μF]	—	—	—	200	200	200	200	540	540	—	—	640	800
Filament AC-5b	230/240V [A]	5	9	9	12	16	18	22	30	37	18	25	43	60
Switching of Low Inductive Loads in Home Appliances and Similar Applications per IEC 61095 (50 Hz)														
AC-7a	230V [A]	20	20	20	32	32	32	32	45	45	—	—	63	—
	400V [A]	20	20	20	32	32	32	32	45	45	—	—	63	—
	440V [A]	—	—	—	32	32	32	32	45	45	—	—	63	—
Switching of Motor Load for Home Appliances (50 Hz)														
AC-7b	230V [A]	6	11	11	10.5	14	19	23	30	—	—	—	—	—
	400V [A]	6	11	11	9	12	16	20	30	—	—	—	—	—
	440V [A]	—	—	—	7.5	10	13.5	18	27	—	—	—	—	—

* Inductance of leads between capacitors in parallel: min. 6 μH (100-C09...C30 contactors: min 30 μH)

100/104-C, 100S/104S-C					100/104-D, 100S-D										
72	85	90*200	90*400	97	115	140	140	180	180	210	250	300	420	630	860
X	X	X	X	X	X	X	—	X	—	—	—	—	—	—	—
—	—	—	—	—	X	—	X	—	X	X	X	X	X	X	X

Switching of 3-phase Capacitors, AC-6b (50 Hz)

28	28	—	—	28	45	70	70	70	70	98	98	125	139	—	—
29	29	—	—	29	47	73	73	73	73	102	102	131	145	—	—
48	48	—	—	48	78	121	121	121	121	170	170	218	242	—	—
50	50	—	—	50	81	126	126	126	126	176	176	226	252	—	—
55	60	—	—	60	97	152	152	152	152	212	212	273	303	—	—
55	60	—	—	60	134	209	209	209	209	293	293	376	418	—	—
—	—	—	—	—	194	303	303	303	303	424	424	546	606	—	—
28	28	—	—	28	38	59	59	59	59	84	84	106	119	—	—
29	29	—	—	29	39	61	61	61	61	87	87	111	124	—	—
48	48	—	—	48	65	102	102	102	102	145	145	184	206	—	—
50	50	—	—	50	68	106	106	106	106	151	151	191	214	—	—
50	55	—	—	55	82	127	127	127	127	182	182	230	258	—	—
50	55	—	—	55	113	176	176	176	176	251	251	318	356	—	—
—	—	—	—	—	164	255	255	255	255	364	364	461	515	—	—
28	28	—	—	28	45	70	70	70	70	98	98	125	139	—	—
29	29	—	—	29	47	73	73	73	73	102	102	131	145	—	—
48	48	—	—	48	56	76	76	111	111	170	170	218	242	—	—
50	50	—	—	50	56	76	76	112	112	170	176	226	252	—	—
50	50	—	—	50	56	76	76	113	113	172	212	273	303	—	—
50	50	—	—	50	57	78	78	114	114	174	247	356	418	—	—
—	—	—	—	—	58	79	79	116	116	177	251	361	606	—	—
28	28	—	—	28	38	59	59	59	59	84	84	106	119	—	—
29	29	—	—	29	39	61	61	61	61	87	87	111	124	—	—
48	48	—	—	48	56	76	76	102	102	145	145	184	206	—	—
50	50	—	—	50	56	76	76	106	106	151	151	191	214	—	—
50	50	—	—	50	56	76	76	113	113	172	182	230	258	—	—
50	50	—	—	50	57	78	78	114	114	174	247	318	356	—	—
—	—	—	—	—	58	79	79	116	116	177	251	361	515	—	—

60 Hz Single Capacitor — 40 °C

28	28	—	—	28	39	61	61	61	61	85	85	109	121	—	—
29	29	—	—	29	45	70	70	70	70	98	98	125	139	—	—
50	50	—	—	50	89	139	139	139	139	195	195	251	279	—	—
50	50	—	—	50	116	182	182	182	182	255	255	327	364	—	—

60 Hz Group Capacitor — 40 °C

28	28	—	—	28	39	61	61	61	61	85	85	109	121	—	—
29	29	—	—	29	45	70	70	70	70	98	98	125	139	—	—
50	50	—	—	50	56	76	76	112	112	171	195	251	279	—	—
50	50	—	—	50	57	77	77	114	114	173	246	327	364	—	—

Switching of Lamps

85	90	115	115	115	144	225	225	225	225	315	315	405	450	—	—
81	90	95	95	100	122	189	189	189	189	270	270	342	383	—	—

Individually compensated:

Max. capacitance at expected

4 000	4 700	—	—	4 700	—	—	—	—	—	—	—	—	—	—	—
2 000	2 350	—	—	2 350	—	—	—	—	—	—	—	—	—	—	—
800	940	—	—	940	—	—	—	—	—	—	—	—	—	—	—
70	76	60	75	90	120	140	140	170	170	210	250	300	420	—	—

Switching of Low Inductive Loads in Home Appliances and Similar Applications per IEC 61095 (50 Hz)

—	—	—	—	—	—	—	—	—	—	—	—	—	—	—	—
—	—	—	—	—	—	—	—	—	—	—	—	—	—	—	—
—	—	—	—	—	—	—	—	—	—	—	—	—	—	—	—

Switching of Motor Load for Home Appliances (50 Hz)

—	—	—	—	—	—	—	—	—	—	—	—	—	—	—	—
—	—	—	—	—	—	—	—	—	—	—	—	—	—	—	—
—	—	—	—	—	—	—	—	—	—	—	—	—	—	—	—

IEC Contactors

Specifications

2



















Coil Type :		100/104-K			100/104-C, 100S/104S-C										
		05	09	12	09	12	16	23	30	37	40*200	40*400	43	60	
		X	X	X	X	X	X	X	X	X	X	X	X	X	X
Conventional		X	X	X	X	X	X	X	X	X	X	X	X	X	
Electronic — EI		—	—	—	—	—	—	—	—	—	—	—	—	—	
Switching of Hermetically Sealed Cooling Compressor Motors - manual reset of overload release (50 Hz)															
AC-8a	400V	[A]	11	18	18	12	16	22	32	38	45	—	—	63	72
	500V	[A]	10	15	15	12	16	22	32	38	45	—	—	63	72
	690V	[A]	—	—	—	8	10	14	20	28	35	—	—	42	56
- automatic reset of overload release															
AC-8b	400V	[A]	—	—	—	5.5	7	9.3	12	13	14	—	—	16	24
	500V	[A]	—	—	—	5.5	7	9.3	12	13	14	—	—	16	24
	690V	[A]	—	—	—	5.5	7	9.3	12	13	14	—	—	16	24
Switching of DC Loads															
Non-inductive or slightly inductive loads or resistance furnaces DC-1, 60 °C															
1 pole	24V	[A]	6	9	9	25	25	32	32	45	45	45	45	50	70
	48/60V	[A]	4/1	6/1.5	6/1.5	20	20	20	20	25	25	25	25	30	40
	110V	[A]	0.6	1	1	6	6	6	6	8	8	10	10	9	11
	220V	[A]	0.2	0.3	0.3	1.5	1.5	1.5	1.5	1.5	1.5	1.5	1.5	1.5	2
	440V	[A]	0.08	0.1	0.1	0.4	0.4	0.4	0.4	0.4	0.4	0.4	0.4	0.5	0.5
2 poles in series	24V	[A]	6	9	9	25	25	32	32	45	45	45	45	50	70
	48/60V	[A]	6	8	8	25	25	32	32	45	45	45	45	50	70
	110V	[A]	4	6	6	25	25	32	32	45	45	45	45	50	70
	220V	[A]	0.8	1.2	1.2	8	8	8	10	10	10	10	10	10	15
3 poles in series	24V	[A]	6	9	9	25	25	32	32	45	45	—	45	63	90
	48/60V	[A]	6	9	9	25	25	32	32	45	45	—	45	63	90
	110V	[A]	6	9	9	25	25	32	32	45	45	—	45	63	90
	220V	[A]	3	4	4	25	25	32	32	45	45	—	45	50	70
	440V	[A]	0.4	0.6	0.6	3	3	3	3	3.5	3.5	—	3.5	4	5
Shunt-wound Motors															
Starting, reverse current braking, reversing, stepping DC-3, 60 °C															
3 poles in series	24V	[A]	5	9	9	25	25	32	32	45	45	—	—	63	90
	48/60V	[A]	4	6	6	25	25	32	32	45	45	—	—	50	70
	110V	[A]	2	3	3	20	20	25	25	30	30	—	—	35	70
	220V	[A]	0.8	1.2	1.2	6	6	6	10	15	15	—	—	20	25
	440V	[A]	0.15	0.2	0.2	0.6	0.6	0.6	0.6	0.6	0.6	—	—	0.6	0.6
Series-wound Motors															
Starting, reverse current braking, reversing, stepping DC-5, 60 °C															
3 poles in series	24V	[A]	5	9	9	25	25	32	32	45	45	—	—	63	90
	48/60V	[A]	2	3	3	25	25	32	32	45	45	—	—	50	70
	110V	[A]	0.6	1	1	20	20	25	25	30	30	—	—	35	70
	220V	[A]	0.1	0.1	0.1	6	6	6	10	15	15	—	—	20	25
	440V	[A]	—	—	—	0.6	0.6	0.6	0.6	0.6	0.6	—	—	0.6	0.6
Short Time Withstand I_{cw}, 60 °C															
	10 s	[A]	60	96	96	170	170	170	215	300	304	304	304	375	700
Resistance and Power Dissipation															
Main current circuit resistance		[mΩ]	2.2	2.2	2.2	2.7	2.7	2.7	2	2	2	2	1.5	1.5	0.9
Power dissipation by all circuits at I_e AC-3/400V		[W]	0.3	0.9	0.9	0.66	1.2	2.1	3.2	5.4	8.2	11.3	8.4	8.3	9.7
Total power dissipation															
At I_e AC-3/400V	AC	[W]	2.1	2.7	2.7	3.3	3.8	4.7	6.2	8.4	11.2	26.1	37.4	11.5	11
	DC	[W]	2.9	3.5	3.5	6.7	7.2	8.1	12.4	14.6	17.4	32.6	43.9	18.4	11
Lifespan															
Mechanical AC control		[Mil. operations]	15	15	15	13	13	13	13	13	13	10	10	12	6
Mechanical DC control		[Mil. operations]	15	15	15	13	13	13	13	13	13	10	10	13	6
Electrical AC-3 (400 V)		[Mil. operations]	0.7	0.7	0.7	1.3	1.3	1.3	1.3	1.3	1.3	—	—	1	1
Weight															
AC	Non-Rev.	kg (lbs.)	0.16 (0.35)	0.16 (0.35)	0.16 (0.35)	0.39 (0.86)	0.39 (0.86)	0.39 (0.86)	0.39 (0.86)	0.48 (1.06)	0.49 (1.08)	0.63 (1.39)	0.63 (1.39)	0.51 (1.12)	1.45 (3.20)
	Rev.	kg (lbs.)	—	—	—	0.85 (1.89)	0.85 (1.89)	0.85 (1.89)	0.85 (1.89)	1.08 (2.39)	1.08 (2.39)	—	—	1.15 (2.54)	3.14 (6.92)
DC	Non-Rev.	kg (lbs.)	0.2 (0.44)	0.2 (0.44)	0.2 (0.44)	0.6 (1.32)	0.6 (1.32)	0.6 (1.32)	0.73 (1.61)	0.85 (1.87)	0.85 (1.87)	1.12 (2.46)	1.12 (2.46)	1.0 (2.20)	1.47 (3.24)
	Rev.	kg (lbs.)	—	—	—	1.27 (2.81)	1.27 (2.81)	1.27 (2.81)	1.53 (3.39)	1.81 (4.0)	1.81 (4.0)	—	—	2.13 (4.7)	3.22 (7.1)

100/104-C, 100S/104S-C					100/104-D, 100S-D										
72	85	90*200	90*400	97	115	140	140	180	180	210	250	300	420	630	860
X	X	X	X	X	X	X	—	X	—	—	—	—	—	—	—
—	—	—	—	—	X	—	X	—	X	X	X	X	X	X	X
Switching of Hermetically Sealed Cooling Compressor Motors - manual reset of overload release (50 Hz)															
85	100	—	—	115	192	210	210	—	—	—	—	—	—	—	—
85	100	—	—	115	192	192	210	—	—	—	—	—	—	—	—
67	80	—	—	90	192	192	210	—	—	—	—	—	—	—	—
- automatic reset of overload release															
30	35	—	—	35	—	—	—	—	—	—	—	—	—	—	—
30	35	—	—	35	—	—	—	—	—	—	—	—	—	—	—
30	35	—	—	35	—	—	—	—	—	—	—	—	—	—	—
Switching of DC Loads															
Non-inductive or slightly inductive loads or resistance furnaces DC-1, 60 °C															
80	80	80	80	80	135	210	210	210	210	300	300	380	425	—	—
40	40	40	40	40	135	210	210	210	210	300	300	380	425	—	—
11	11	11	11	11	135	210	210	210	210	300	300	380	425	—	—
2	2	1.8	1.8	2	3	3.3	3.3	3.3	3.3	4.9	4.9	4.9	5.2	—	—
0.5	0.5	0.5	0.5	0.5	0.6	0.75	0.75	0.75	0.75	1	1	1	1.2	—	—
80	80	80	80	80	135	210	210	210	210	300	300	380	425	—	—
80	80	80	80	80	135	210	210	210	210	300	300	380	425	—	—
80	80	80	80	80	135	210	210	210	210	300	300	380	425	—	—
15	15	15	15	15	135	210	210	210	210	300	300	380	425	—	—
1.5	1.5	1.5	1.5	1.5	3	3.3	3.3	3.3	3.3	4.9	4.9	4.9	5.2	—	—
90	100	—	100	100	135	210	210	210	210	300	300	380	425	—	—
90	100	—	100	100	135	210	210	210	210	300	300	380	425	—	—
90	100	—	100	100	135	210	210	210	210	300	300	380	425	—	—
80	80	—	80	80	135	210	210	210	210	300	300	380	425	—	—
5	5	—	5	5	11	11	11	11	11	14	14	14	15	—	—
Shunt-wound Motors															
Starting, reverse current braking, reversing, stepping DC-3, 60 °C															
90	100	—	—	100	135	210	210	210	210	300	300	380	425	—	—
70	80	—	—	80	135	210	210	210	210	300	300	380	425	—	—
70	80	—	—	80	135	210	210	210	210	300	300	380	425	—	—
25	30	—	—	30	135	210	210	210	210	300	300	380	425	—	—
0.6	0.6	—	—	0.6	3	3.5	3.5	3.5	3.5	4.1	4.1	4.1	5.8	—	—
Series-wound Motors															
Starting, reverse current braking, reversing, stepping DC-5, 60 °C															
90	100	—	—	100	135	210	210	210	210	300	300	380	425	—	—
70	80	—	—	80	135	210	210	210	210	300	300	380	425	—	—
70	80	—	—	80	135	210	210	210	210	300	300	380	425	—	—
25	30	—	—	30	135	210	210	210	210	300	300	380	425	—	—
0.6	0.6	—	—	0.6	1.2	2.1	2.1	2.1	2.1	2.4	2.4	2.4	3	—	—
Short Time Withstand I_{CW}, 60 °C															
700	700	700	700	840	1040	1240	1360	1480	1480	2360	2520	2840	4700	6300	7000
Resistance and Power Dissipation															
0.9	0.9	0.8	0.7	0.6	0.4	0.42	0.42	0.42	0.42	0.22	0.22	0.18	0.15	0.19	0.14
14	19.5	13.5	11.8	17	14.5	24.6	24.6	40.8	40.8	29.4	41.7	48.6	79.5	78.4	103.2
Total power dissipation															
13.8	17.5	36	56.3	26	24.5 (20.5)	34.6	30.6	50.8	46.8	35.4	47.7	54.6	86.5	105.4	133.2
13.8	17.5	32.5	52.8	23	22.5 (20.5)	32.6	30.6	48.8	46.8	35.4	47.7	54.6	86.5	105.4	133.2
Lifespan															
6	6	6	6	6	10	10	10	10	10	10	10	10	10	2	2
6	6	6	6	6	10	10	10	10	10	10	10	10	10	2	2
1	1	—	—	1	1	1	1	1	1	1	1	1	1	—	—
Weight															
1.45 (3.2)	1.45 (3.2)	—	—	1.45 (3.2)	3.3 (7.28) [3.8 (8.38)]*	3.3 (7.28)	3.8 (8.38)	3.3 (7.28)	3.8 (8.38)	7.5 (16.53)	7.5 (16.53)	7.5 (16.53)	7.5 (16.53)	28.6 (63)	28.6 (63)
3.14 (6.92)	3.14 (6.92)	—	—	3.14 (6.92)	—	—	—	—	—	—	—	—	—	—	—
1.47 (3.24)	1.47 (3.24)	—	—	1.47 (3.24)	3.3 (7.28) [3.8 (8.38)]*	3.3 (7.28)	3.8 (8.38)	3.3 (7.28)	3.8 (8.38)	7.5 (16.53)	7.5 (16.53)	7.5 (16.53)	7.5 (16.53)	28.6 (63)	28.6 (63)
3.22 (7.1)	3.22 (7.1)	—	—	3.22 (7.1)	—	—	—	—	—	—	—	—	—	—	—

* Values in brackets refer to electronic coil (EI) version.

IEC Contactors

Specifications



Coil Type : Conventional Electr. — EI		100-KR		100/104-K			100/104-C, 100S/104S-C											
		05	09	05	09	12	09	12	16	23	30	37	40	43	60	72	85	97
		X	X	X	X	X	X	X	X	X	X	X	X	X	X	X	X	X
		—	—	—	—	—	—	—	—	—	—	—	—	—	—	—	—	—
Conductor Cross Sections - Main Contacts				 *			 *			 †				 †				
Terminal type																		
	(1) conductor [mm ²]	0.50...2.5		0.75...2.5			1...4			2.5...10				2.5...16				
	(2) conductors [mm ²]	0.50...2.5		0.75...2.5			1...4			2.5...10				2.5...16				
	(1) conductor [mm ²]	0.75...2.5§		1...4			1.5...6			2.5...16				2.5...25				
	(2) conductors [mm ²]	0.75...2.5§		1...2.5+ 1...4			1.5...6			2.5...16				2.5...16				
	b max. [mm]	—		—			—			—				—				
	c max. [mm]	—		—			—			—				—				
	s max. [mm]	—		—			—			—				—				
	Ø min. [mm]	—		—			—			—				—				
Recommended torque [N•m]		—		1.2			1.5...2.0			2.5...3.5				2.5...3.5				
Cross section per UL/CSA [AWG]		18...14§		18...12			16...10			14...6				14...6 14...4				
Recommended torque [lb-in]		—		10.6			13.3...17.7			22...31				22...31				
With terminal lug kit		—		—			—			—				—				
Cross section per UL/CSA [AWG]		—		—			—			—				—				
Recommended torque [lb-in]		—		—			—			—				—				
With Frame Terminal Block		—		—			—			—				—				
	top opening [mm ²]	—		—			—			—				—				
	bottom opening [mm ²]	—		—			—			—				—				
	top opening [mm ²]	—		—			—			—				—				
	bott. opening [mm ²]	—		—			—			—				—				
	b max. [mm ²]	—		—			—			—				—				
	s top [mm ²]	—		—			—			—				—				
	s bottom [mm ²]	—		—			—			—				—				
Recommended torque [N•m]		—		—			—			—				—				
Cross section per UL/CSA top [AWG]		—		—			—			—				—				
bottom [AWG]		—		—			—			—				—				
Recommended torque [lb-in]		—		—			—			—				—				

* Pozidriv No. 2 / Blade No. 3 screw

† Pozidriv No. 2 / Blade No. 4 screw

‡ Hexagonal socket screw

§ Fine- or coarse-stranded only

100/104-D, 100S-D								
115	140	180	210	250	300	420	630	860
X	X	X	—	—	—	—	—	—
X	X	X	X	X	X	X	X	X
								
—	—	—	—	—	—	—	—	—
—	—	—	—	—	—	—	—	—
—	—	—	—	—	—	—	—	—
25	—	—	—	30	—	—	52	52
12.5	—	—	—	15	—	—	22	22
5	—	—	—	6	—	—	2 x 8	2 x 8
8.3	—	—	—	10.5	—	—	13	13
22	—	—	—	43	—	—	68	68
—	—	—	—	—	—	—	—	—
195	—	—	—	380	—	—	600	600
100-DL180‡	—	—	—	100-DL420‡	—	—	100-DL630	100-DL860
6...300 MCM	—	—	—	(2x) 4...350 MCM	—	—	(2X) 2/0...500MCM	(4X) 2/0...500MCM
88...106	—	—	—	375	—	—	400	400
100-DTB180‡	—	—	—	100-DTB420*	—	—	—	—
16...35	—	—	—	25...185*	—	—	—	—
16...95	—	—	—	25...185	—	—	—	—
16...50	—	—	—	25...240	—	—	—	—
16...120	—	—	—	25...240	—	—	—	—
20	—	—	—	25	—	—	—	—
3...9	—	—	—	6...20	—	—	—	—
3...14	—	—	—	6...20	—	—	—	—
14	—	—	—	25	—	—	—	—
6...1 / 0 AWG	—	—	—	4 AWG...600 MCM	—	—	—	—
6 AWG...250 MCM	—	—	—	4 AWG...600 MCM	—	—	—	—
124	—	—	—	220	—	—	—	—

* Pozidriv No. 2 / Blade No. 3 screw
 * Pozidriv No. 2 / Blade No. 4 screw
 ‡ Hexagonal socket screw
 § Hexagonal screw

IEC Contactors

Specifications

Short-Circuit Coordination Data†

Coil Type :	Conventional Electronic - EI	100/104-K						100/104-C, 100S/104S-C												
		05	09	12	09	12	16	23	30	37	40*200	40*400	43	60	72	85	90*200	90*400	97	
		X	X	X	X	X	X	X	X	X	X	X	X	X	X	X	X	X	X	X
—	—	—	—	—	—	—	—	—	—	—	—	—	—	—	—	—	—	—		

Short Circuit Coordination (Max. Fuse or Circuit Breaker Rating)

Per IEC 60947-4-1 (contactor and fuses only)

DIN Fuses - gG, gL		50 kA Available Fault Current																	
Type "1" (690V)	[A]	35	35	35	50	50	50	80	125	125	160	160	160	250	250	250	250	250	250
Type "2" (400V)	[A]	16	20	20	25	35	35	40	80	80	63	80	100	160	160	160	160	100	200
Type "2" (690V)	[A]	—	—	—	25	35	35	40	80	80	63	80	100	160	160	160	160	100	200
BS88 Fuses		65 kA Available Fault Current																	
Type "1" (415V)	[A]	—	—	—	25	32	40	50	63	80	—	—	80	100	160	160	—	—	TBD
Type "2" (415V)	[A]	—	—	—	20	25	32	50	63	80	—	—	80	100	125	160	—	—	TBD

Per UL 508 and CSA 22.2 No. 14 (contactor and fuses or circuit breaker only)

UL Class K5 and RK5 Fuses		5 kA Available Fault Current																	
UL Listed Combination (600V)	[A]	40	40	40	35	40	70	90	110	125	125	125	150	200	—	—	—	—	—
UL Class K5 and RK5 Fuses		10 kA Available Fault Current																	
UL Listed Combination (600V)	[A]	—	—	—	—	—	—	—	—	—	—	—	—	—	250	300	300	300	350
UL Class L Fuses		18 kA Available Fault Current																	
UL Listed Combination (600V)	[A]	—	—	—	—	—	—	—	—	—	—	—	—	—	—	—	—	—	—
UL Class L Fuses		30 kA Available Fault Current																	
UL Listed Combination (600V)	[A]	—	—	—	—	—	—	—	—	—	—	—	—	—	—	—	—	—	—
UL Class L Fuses		42 kA Available Fault Current																	
UL Listed Combination (600V)	[A]	—	—	—	—	—	—	—	—	—	—	—	—	—	—	—	—	—	—
UL Class CC and CSA HRCI-MISC Fuses		50 kA Available Fault Current																	
UL Listed Combination (600V)	[A]	30	30	30	—	—	—	—	—	—	—	—	—	—	—	—	—	—	—
UL Class J and CSA HRCI-J Fuses		50 kA Available Fault Current																	
UL Listed Combination (600V)	[A]	30	30	30	—	—	—	—	—	—	—	—	—	—	—	—	—	—	—
UL Class CC and CSA HRCI-MISC Fuses		100 kA Available Fault Current																	
UL verified combination to IEC 60947-4-1 "Type 2"	[A]	—	—	—	20§	20	30	40	—	—	—	—	—	—	—	—	—	—	—
UL Class J and CSA HRCI-J Fuses		100 kA Available Fault Current																	
UL verified combination to IEC 60947-4-1 "Type 2"	[A]	—	—	—	20§	20	30	40	50	50	—	—	70	80	100	150	—	—	TBD
UL Inverse-Time Circuit Breaker		5 kA Available Fault Current																	
UL Listed Combination (480V)	[A]	—	—	—	30	30	50	50	125	125	—	—	125	250	—	—	—	—	—
UL Listed Combination (600V)	[A]	—	—	—	—	—	—	—	125	125	—	—	125	250	—	—	—	—	—
UL Inverse-Time Circuit Breaker		10 kA Available Fault Current																	
UL Listed Combination (600V)	[A]	—	—	—	—	—	—	—	—	—	—	—	—	—	250	250	—	—	250
UL Inverse-Time Circuit Breaker		18 kA Available Fault Current																	
UL Listed Combination (600V)	[A]	—	—	—	—	—	—	—	—	—	—	—	—	—	—	—	—	—	—
UL Inverse-Time Circuit Breaker		30 kA Available Fault Current																	
UL Listed Combination (600V)	[A]	—	—	—	—	—	—	—	50	50	—	—	50	110	110	110	—	—	TBD
UL Inverse-Time Circuit Breaker		42 kA Available Fault Current																	
UL Listed Combination (600V)	[A]	—	—	—	—	—	—	—	—	—	—	—	—	—	—	—	—	—	—
UL Inverse-Time Circuit Breaker		50 kA Available Fault Current																	
UL Listed Combination (480V)	[A]	—	—	—	—	—	—	—	50	50	—	—	50	—	—	—	—	—	—
UL Inverse-Time Circuit Breaker		65 kA Available Fault Current																	
UL Listed Combination (480V)	[A]	—	—	—	—	—	—	—	—	—	—	—	—	110	110	110	—	—	TBD

§ 15 A max. fuse for Type 2 coordination.

† See www.ab.com/certifications/ul508a for complete short-circuit current ratings.

100/104-D, 100S-D									
115	140/180	140	180	210	250	300	420	630	860
X	X	—	—	—	—	—	—	—	—
X	—	X	X	X	X	X	X	X	X

50 kA Available Fault Current									
250	315	315	355	500	500	630	630	*	*
200	250	250	315	400	400	500	500	*	*
200	250	250	315	400	400	500	500	*	*

65 kA Available Fault Current									
200	250	250	250	355	355	450	630	*	*
200	250	250	250	355	355	450	560	*	*

5 kA Available Fault Current									
—	—	—	—	—	—	—	—	—	—

10 kA Available Fault Current									
250	350/450	350	450	500	—	—	—	—	—

18 kA Available Fault Current									
—	—	—	—	—	700	700	1000	—	—

30 kA Available Fault Current									
—	—	—	—	—	—	—	—	2000	—

42 kA Available Fault Current									
—	—	—	—	—	—	—	—	—	2500

50 kA Available Fault Current									
—	—	—	—	—	—	—	—	—	—

50 kA Available Fault Current									
—	—	—	—	—	—	—	—	—	—

100 kA Available Fault Current									
—	—	—	—	—	—	—	—	—	—

100 kA Available Fault Current									
200	250/300	250	300	400	400	500	600	*	*

5 kA Available Fault Current									
—	—	—	—	—	—	—	—	—	—
—	—	—	—	—	—	—	—	—	—

10 kA Available Fault Current									
150	200/250	200	250	300	—	—	—	—	—

18 kA Available Fault Current									
—	—	—	—	—	400	400	600	—	—

30 kA Available Fault Current									
125	200	200	200	250	400	400	600	1200	—

42 kA Available Fault Current									
—	—	—	—	—	—	—	—	—	1200

50 kA Available Fault Current									
—	—	—	—	—	—	—	—	—	—

65 kA Available Fault Current									
125	200	200	200	250	400	400	600	*	*

* To be determined.

IEC Contactors

Specifications

2

Coil Type			100/104-K			100/104-C, 100S/104S-C																				
			05	09	12	09	12	16	23	30	37	40*200	40*400	43	60	72	85	90*200	90*400	97						
			X	X	X	X	X	X	X	X	X	X	X	X	X	X	X	X	X	X	X					
Conventional			Electronic — EI																							
Coil Type			Electronic — EI																							
Operating Limits																										
50 Hz, 60 Hz, 50/60 Hz	pick-up	[x Us]	0.85...1.1			0.85...1.1			0.85...1.1			0.85...1.1														
	dropout	[x Us]	0.2...0.75			0.3...0.6			0.3...0.6			0.3...0.6														
DC (conventional)	pick-up	[x Us]	0.8...1.1 0.7...1.25§			0.8...1.1			0.8...1.1			0.8...1.1														
	dropout	[x Us]	0.1...0.75			0.1...0.6			0.1...0.6			0.1...0.6														
DC (electronic)	pick-up	[x Us]	—			0.7...1.25			—																	
	dropout	[x Us]	—			0.4			—																	
Coil Consumption																										
50 Hz, 60 Hz, 50/60 Hz	pick-up	[VA/W]	35/32			70/50			70/50			80/60			130/90			130/90			200/110			400/240		
	hold-in	[VA/W]	5/1.8			8/2.6			9/3			9/3			12/3.6			10/3.2			16/4.5			24/9		
DC (conventional)	pick-up	[W]	cold 3.0, warm 2.6			6.5			9.2			9.2			10.1			10.1			200			325		
	hold-in	[W]	cold 3.0, warm 2.6			6.5			9.2			9.2			10.1			10.1			4.5			5.5		
DC (electronic)	pick-up (avg/peak)	[W]	—			10/17			10/17			16/25			—			—								
	hold-in	[W]	—			1.7			1.7			2.5			—			—								
Operating Times																										
AC	closing delay	[ms]	15...40			15...30			15...30			15...30			15...30			20...40			20...40					
	opening delay	[ms]	15...33			10...60			10...60			10...60			10...60			10...60			20...40					
With RC module	opening delay	[ms]	15...28			10...60			10...60			10...60			10...60			10...60			20...40					
DC (conventional)	closing delay	[ms]	18...40			40...70			40...70			50...80			50...80			20...40			15...25 20...25 20...25					
	opening delay	[ms]	6...12			7...15			7...15			7...15			7...15			—			—					
With integ. diode	opening delay	[ms]	8...12			14...20			17...23			17...23			—			17...23			≤ 220V 20...35 ≤ 220V 20...35					
With external diode	opening delay	[ms]	35...50			70...95			80...125			80...125			—			80...125			—					
DC (electronic)	closing delay	[ms]	—			—			25...50			—			—			—								
	opening delay	[ms]	—			—			25...50			—			—			—								
Max. Ripple			—			—			± 15%			—			—			—								
Min. OFF time	[ms]		—			—			200			—			—			—								



§ For 9, 12, 24, and 110V DC coils

Coil Type			100/104-D, 100S-D											
			95/110	140/180	115	140	180	210	250	300	420	630	860	
			X	X	—	—	—	—	—	—	—	—	—	—
Conventional			Electronic — EI											
Coil Type			Electronic — EI											
Operating Limits														
50 Hz, 60 Hz, 50/60 Hz	pick-up	[x Us]	0.85...1.1			0.85...1.1			0.85...1.1			0.8...1.1		
	dropout	[x Us]	0.3...0.6			0.3...0.5			0.3...0.5			0.1...0.8		
DC control	pick-up	[x Us]	0.85...1.1			0.85...1.1			0.85...1.1			0.85...1.1		
	dropout	[x Us]	0.3...0.6			0.3...0.5			0.3...0.5			0.1...0.8		
Coil Consumption														
50 Hz, 60 Hz, 50/60 Hz	pick-up	[VA/W]	650/310			380/240*			490/270*			1915/1720		
	hold-in	[VA/W]	50/10			13/6			18/7			33/30		
DC control	pick-up	[W]	540			265*			340*			1980*		
	hold-in	[W]	8			6			7			30		
Operating Times														
AC	closing delay	[ms]	20...47			20...45			20...45			60...100		
	opening delay	[ms]	6...12			25...110			25...110			70...145		
With RC module	opening delay	[ms]	9...18			—			—			—		
DC	closing delay	[ms]	27...47			25...50			25...50			60...100		
	opening delay	[ms]	12...20			35...110			35...110			70...145		
Integrated diode	opening delay	[ms]	12...20			—			—			—		
External diode	opening delay	[ms]	—			—			—			—		

* Electronic coil drives are designed to minimize power requirements, but this control may exhibit a higher inrush (540 W, < 10 ms) when energizing. This must be taken into account for the proper sizing of supply devices, all-or-nothing relays and cross-sections of coil supply lines. Please contact your local Rockwell Automation sales office or Allen-Bradley distributor for detailed information.



Auxiliary Contacts, Auxiliary Contact Blocks, and Pneumatic Timers

	100-K		100-C, 100S-C				100-D, 100S-D			
	Internal	Front-mounted	Internal	Front-mounted	Front-mounted (Bifurcated)	Side-mounted	Side-mounted			
							Convent'l	Bifurcated	Electronically compatible	
Switching of AC Loads										
AC-12 I _{th}	at 40 °C [A]	10	10	20	10	10	10	16	10	0.1
	at 60 °C [A]	6	6	20	6	6	6	12	6	at 250V
AC-15 at rated voltage of										
24V [A]	6	3	10	6	3	6	5.5	3	(1...100 mA) at 3...125V	
42/48V [A]	6	3	10	6	3	6	5.5	3		
120V [A]	6	3	10	6	3	6	5.5	3		
230V [A]	3	2	10	5.5	3	5.5	5.5	3		
240V [A]	3	2	10	5	3	5	5	3		
400V [A]	1.8	1.2	6	3	2	3	3	2		
415V [A]	1.8	1.2	6	3	2	3	2.5	2		
500V [A]	1.4	1.0	2.5	1.6	1.2	1.6	1.6	1.2		
690V [A]	1.0	0.6	1	1	0.7	1	1	0.7		
Switching of DC Loads										
DC-12 L/R < 1 ms resistive loads at										
24V DC [A]	6	—	12	12	6	6	16	16	—	
48V DC [A]	4	—	9	9	3.2	3.2	9	9	—	
110V DC [A]	0.6	—	3.5	3.5	0.45	0.45	3.5	3.5	—	
220V DC [A]	0.2	—	0.55	0.55	0.18	0.18	0.55	0.55	—	
440V DC [A]	0.08	—	0.2	0.2	0.1	0.1	0.2	0.2	—	
DC-14 L/R < 15 ms inductive loads with economy resistor in series at										
24V DC [A]	4	—	9	9	2	2	9	9	—	
48V DC [A]	2.5	—	5	5	1.6	1.6	5	5	—	
110V DC [A]	0.4	—	2	2	0.3	0.3	2	2	—	
220V DC [A]	0.12	—	0.4	0.4	0.12	0.12	0.4	0.4	—	
440V DC [A]	0.05	—	0.16	0.16	0.05	0.05	0.16	0.1	—	
DC-13 switching electromagnets at										
24V DC [A]	2.8	2.3	5	5	2.5	5	5	5	(1...100 mA) at 3...125V	
48V DC [A]	1.2	1	3	3	1.5	2.5	2	2		
110V DC [A]	0.55	0.55	1.2	1.2	0.6	0.68	0.7	0.7		
220V DC [A]	0.27	0.27	0.6	0.6	0.3	0.32	0.25	0.25		
440V DC [A]	0.15	0.15	0.3	0.15	0.15	0.15	0.12	0.12		
Fuse gG										
Short-circuit protection with no welding of contacts per IEC 60947-5-1										
 [A]	10	10	20	10	10	10	16	16	—	
 [A]	10	10	20	10	10	10	16	16	—	
Protective Separation per IEC 60947-1, Annex N	—	—	between load and auxiliary circuit 320V	between load and auxiliary circuit 440V	between load and auxiliary circuit 440V					
Min. switching capacity according to IEC 60947-5-4	15V/10 mA	15V/2 mA	17V/10 mA	17V/5 mA	5V/3 mA	17V/10 mA	17V/10 mA	5V/2 mA (1 Mio. ops.)	3V/1 mA	
Failure rate	—	—	—	—	—	—	—	<10-8 (less than 1 failure to 100 Mio. operations)	—	
Load Carrying Capacity per UL/CSA										
Rated voltage AC [V]	max. 600		max. 600				max. 600		max. 250	
Continuous rating 40 °C [A]	10		10	10	10	10	10 General purpose		0.1	
Switching capacity AC [A]	A 600	B 600	A 600				Heavy pilot duty (A 600)		0.1	
Rated voltage DC [V]	max. 600		max. 600				max. 600		max. 250	
Switching capacity DC [A]	Q 600		P 600	Q 600	Q 600		Standard pilot duty (P 600)	Standard pilot duty (Q 600)	0.1	

IEC Contactors

Specifications

General

	100-K	100-C, 100S-C	100-D, 100S-D
	05...12	09...97	95...420
Rated Isolation Voltage U_i			
IEC [V]	690	690	1000
UL, CSA [V]	600	600	600
Rated Impulse Voltage Withstand U_{imp} [kV]	6	6	12
Rated Voltage U_e			
AC 50/60 Hz [V]	230, 240, 400, 415, 460, 500, 575, 690	115, 200, 230, 240, 400, 415, 460, 500, 575, 690	230, 240, 400, 415, 500, 690, 1000
DC [V]	24, 48, 110, 220, 440	24, 48, 110, 220, 440	24, 48, 110, 220, 440
Insulation Class of the Coil	Class F per IEC 60085 Class 105 insulation system per UL 508	Class F per IEC 60085	Class B per VDE 0660, Table 22
Rated coil frequency	AC 50/60 Hz, DC	AC 50/60 Hz, DC	AC 50 Hz, 50/60 Hz, DC
Ambient Temperature			
Storage [°C]	-55...+80	-55...+80	-40...+80
Operation at rated voltage [°C]	-25...+60	-25...+60	-25...+60
at 70 °C	15% current reduction against 60°C values		
Climatic Withstand	IEC 60068-2-30	IEC 60068-2-1 / -2 / -30	IEC 60068-2-30
Max. Altitude of Installation Site [m]	2000 NN, per IEC 60947-4	2000 NN, per IEC 60947-1	2000 NN, per IEC 60947-4
Protection Class	IP2X	IP2X	IP00 IEC 60529 / DIN 40 050
Single contactor cover	—	—	IP10 IEC 60529 / DIN 40 050
Contactors with frame terminal block	—	—	IP20 IEC 60529 / DIN 40 050
Auxiliary contact	IP2X	—	IP20 IEC 60529 / DIN 40 050
Protection against Accidental Contact	—	Finger and back-of-hand proof per VDE 0106, part 100	Finger and back-of-hand proof per VDE 0106, part 100
Resistance to Shock	IEC 60068-2	IEC 60068-2-27	IEC 60068-2-27
Resistance to Vibration	IEC 60068-2	IEC 60068-2-6	IEC 60068-2-6
Mechanically Linked Contacts IEC 60947-5-1, Annex L	100-K... (on main device)	100- / 100S-C09...C97 + 100-FA/-FB/-FC, (except L11, L22), 100- / 100S-C09...C43 + 100-FAB/-FBB/-FCB	—
Mirror Contacts IEC 60947-4 Annex F	100-K... + 100-KF...	100- / 100S-C09...C97 + 100-FA/-FB/-FC, (except L11, L22), 100- / 100S-C09...C97 + 100-SA/SB, 100- / 100S-C09...C97 + 100-FAB/-FBB/-FCB	100-D... + 2 x 100-DS1-11 100S-D... + 2 x 100S-DS1-11
Standards Compliance	IEC/EN 60947-1/-4-1/-5-1; UL 508; CSA 22.2. No. 14	IEC/EN 60947-1/-4-1/-5-1; UL 508; CSA 22.2. No. 14	IEC/EN 60947-1/-4-1/-5-1; UL 508; CSA 22.2. No. 14
Certifications	CE, cULus CCC	CE, cULus, CCC	CE, cULus, CCC

2



Life-Load Curves

AC-1

40 °C Non- or slightly inductive loads, resistance furnaces; $U_e = 230...690V$

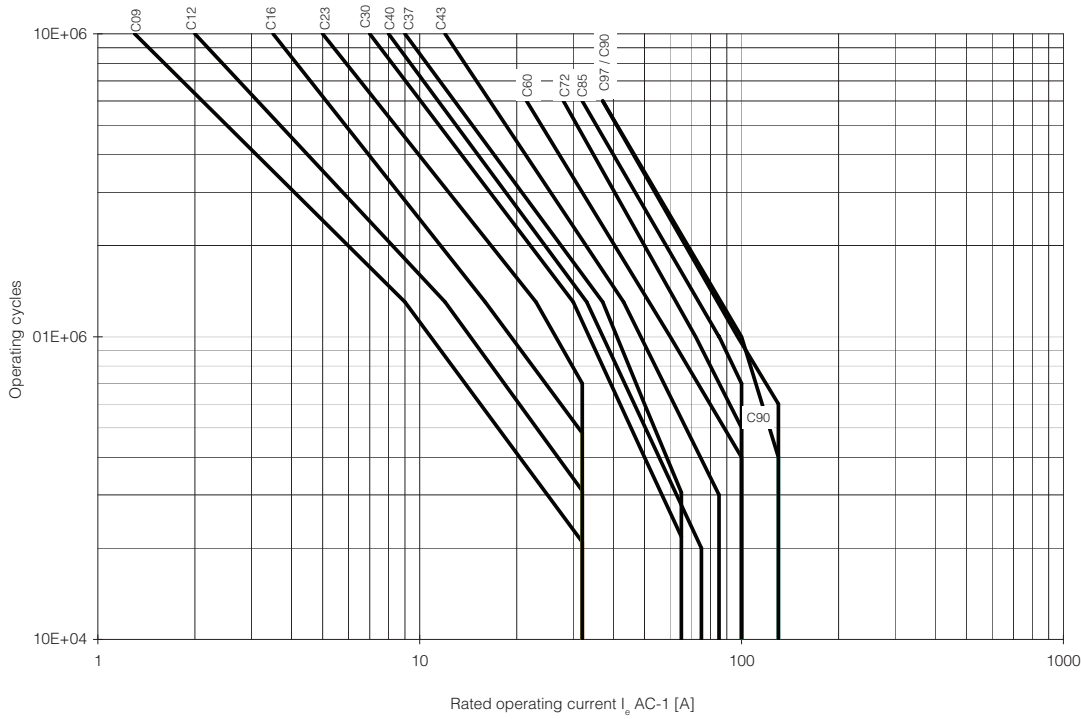

AC-2

Switching of slip-ring motors; $U_e = 230...400...460V$

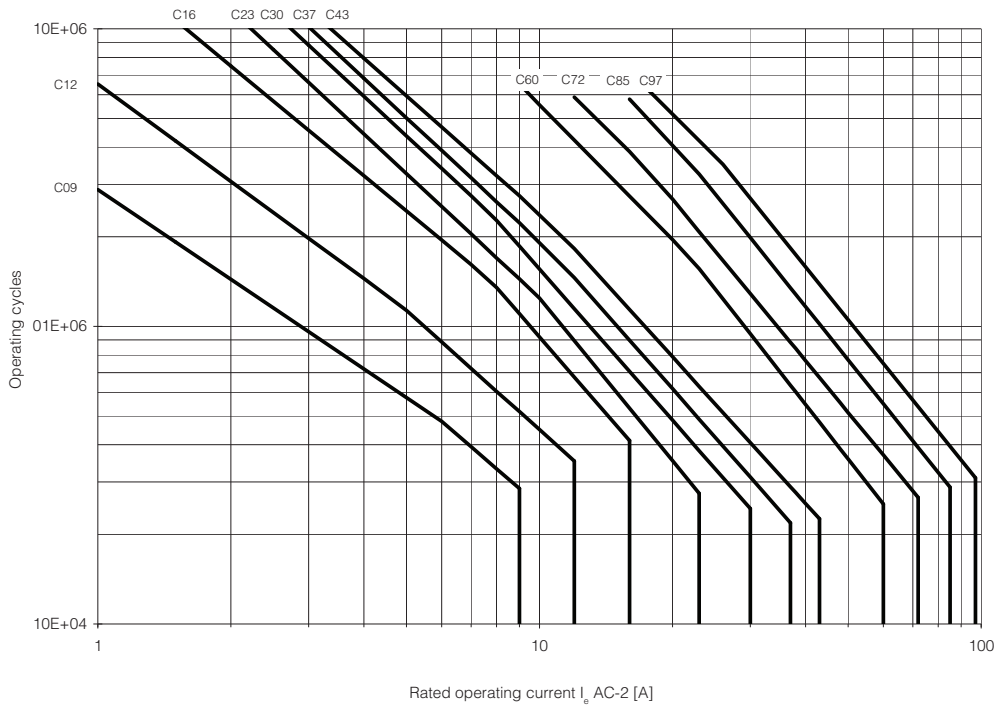

Life-Load Curves

AC-3

Switching of squirrel-cage motors while starting; $U_e = 230...400...460V$

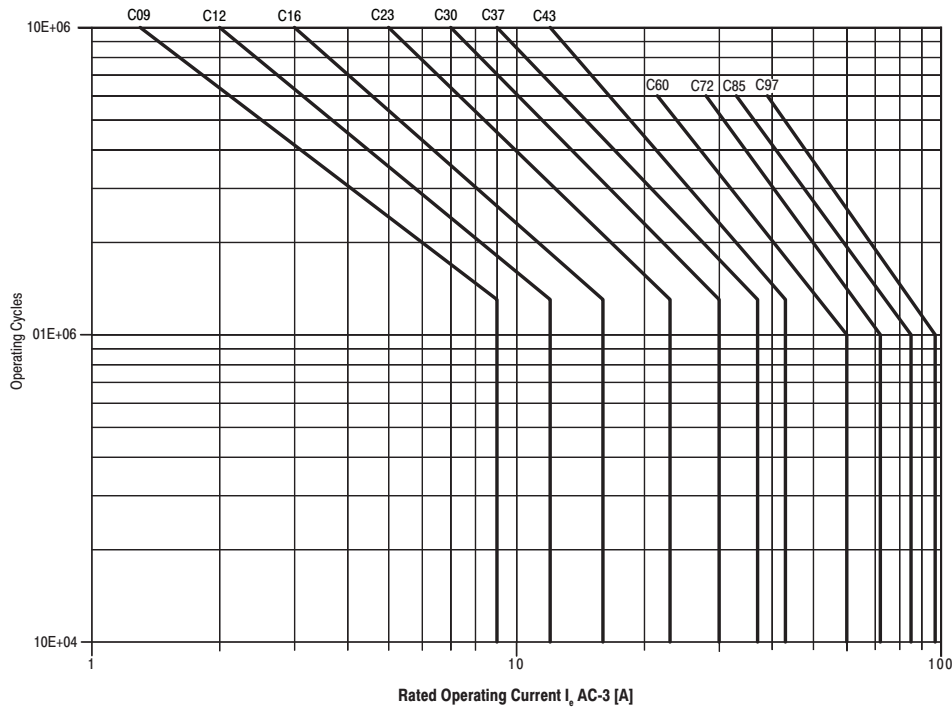

Switching of squirrel-cage motors while starting; $U_e = 500...575V$

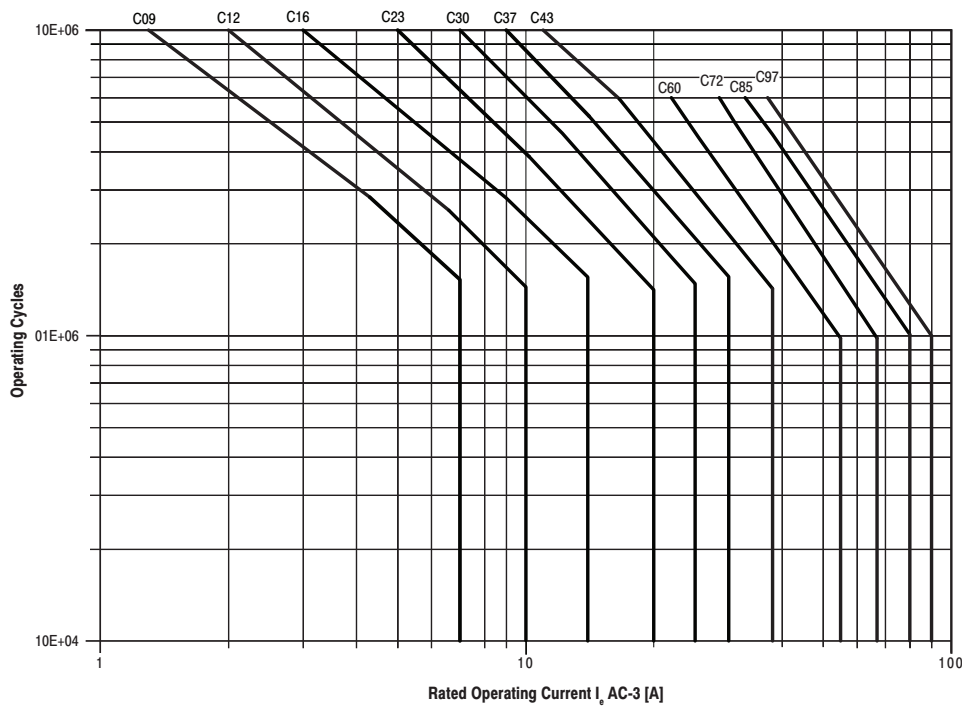

Life-Load Curves

AC-3

Switching of squirrel-cage motors while starting; $U_e = 690V$

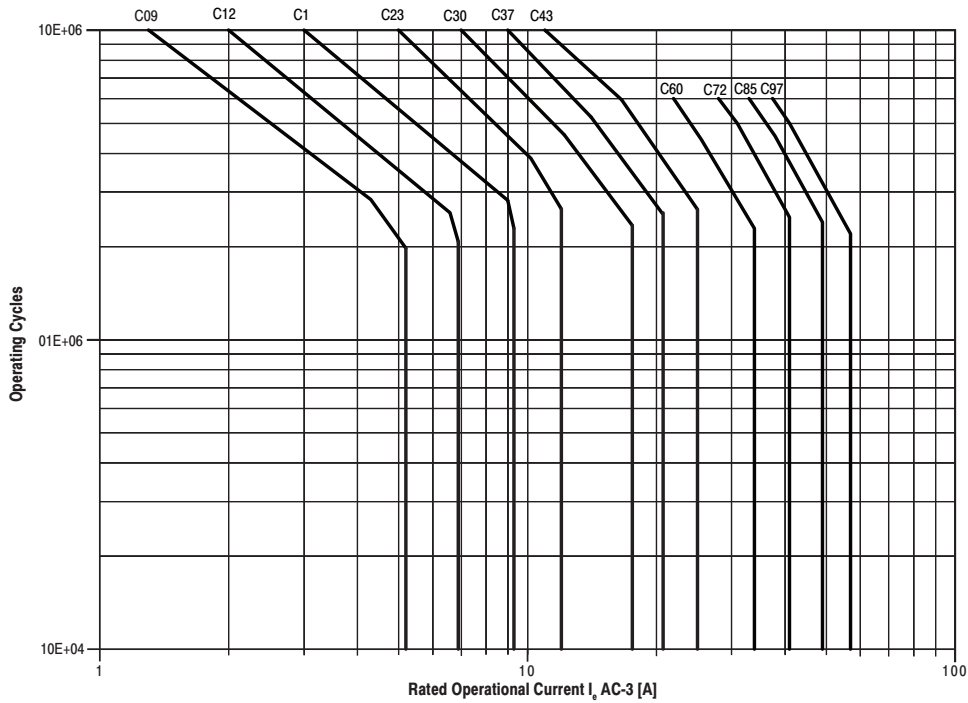

AC-4

Switching of squirrel-cage motors; $U_e = 230...690V$

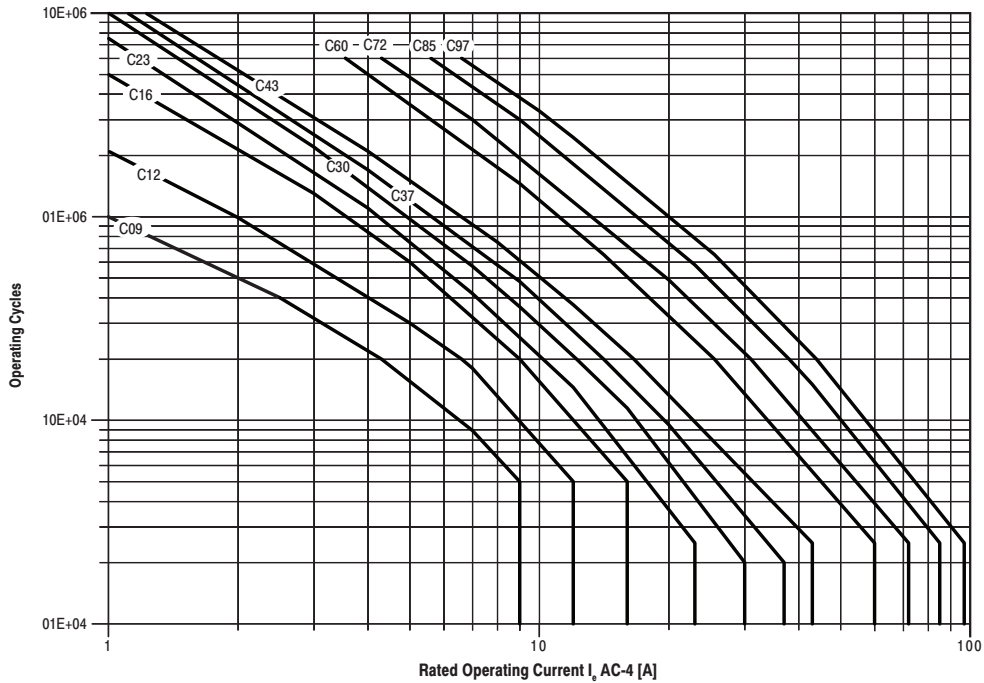

Life-Load Curves

AC-3 & AC-4

10% AC-4 Mixed operation of squirrel-cage motors; $U_e = 230...400...460V$

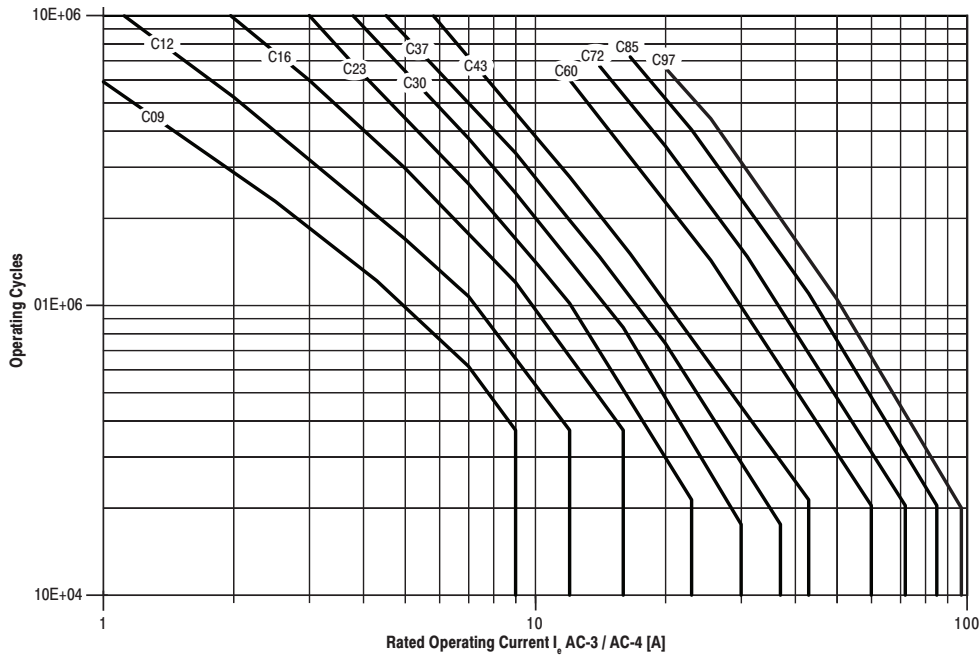

Heavy Duty Starting and Regular Short-time Operation

Bulletin 100-C Contactors

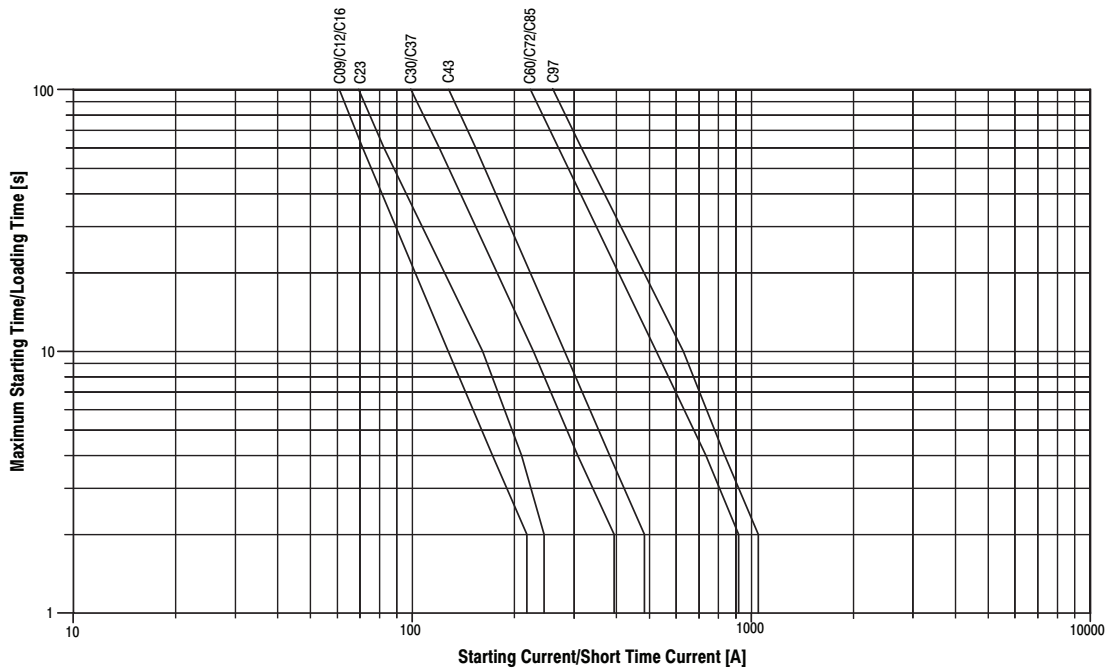

Maximum Operating Rates

AC-1

40 °C Non- or slightly inductive loads, resistance furnaces; $U_e = 230...690V$

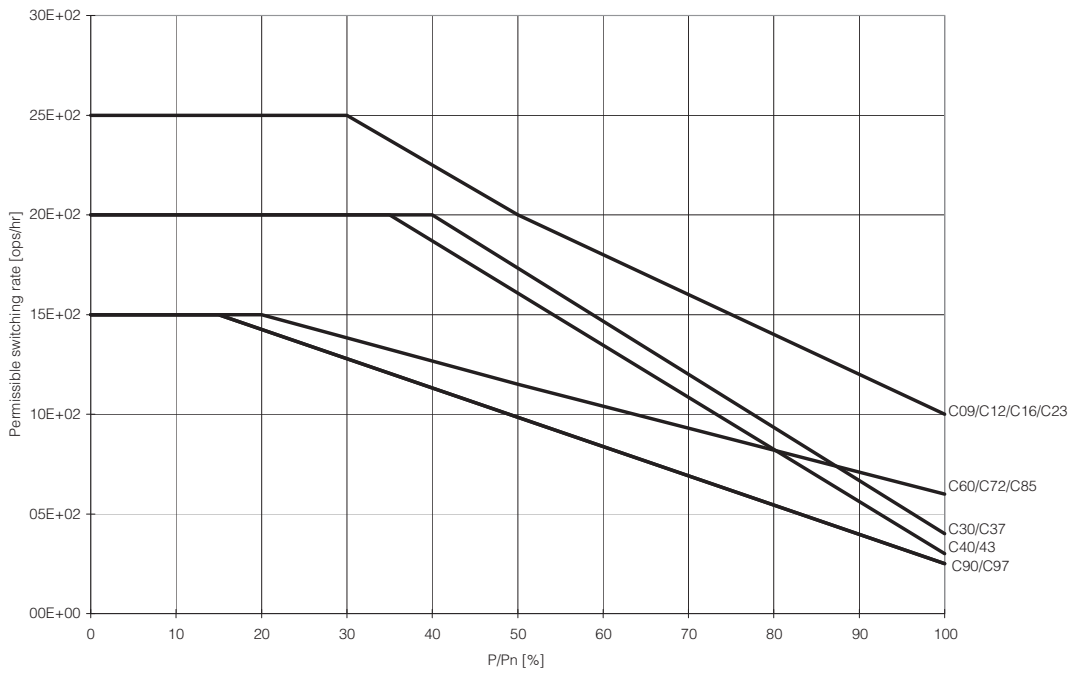

AC-2

Stepping of slip-ring motors; $U_e = 230...460V$

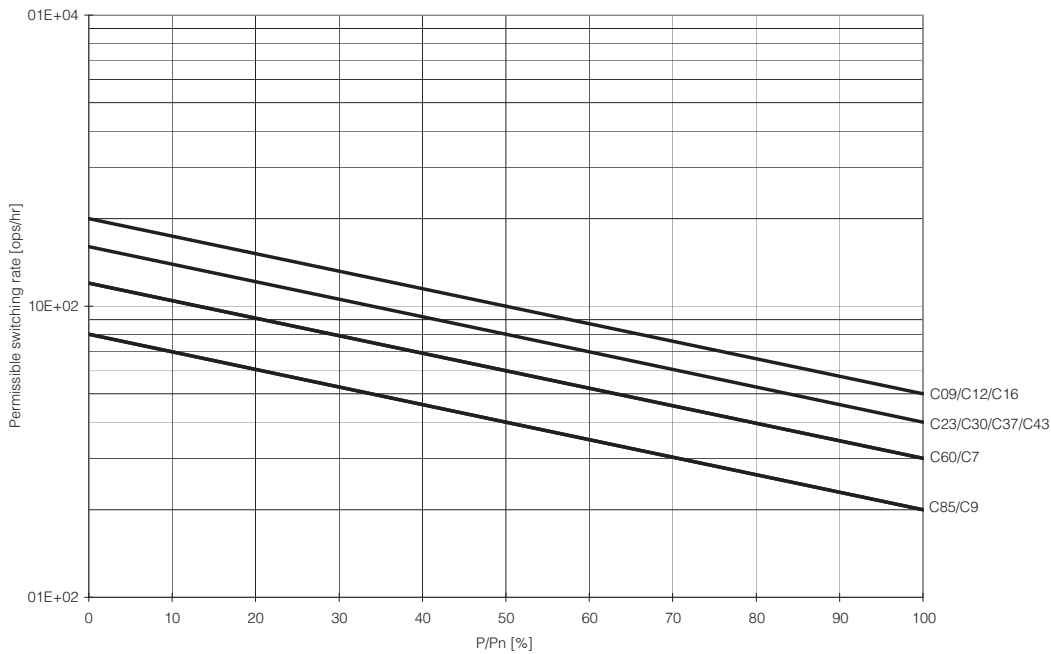

Maximum Operating Rates

AC-3

Switching of squirrel-cage motors while starting; $U_e = 230...460V$

Relative operating time 40%, Starting time $t_A = 0.25\text{ s}$

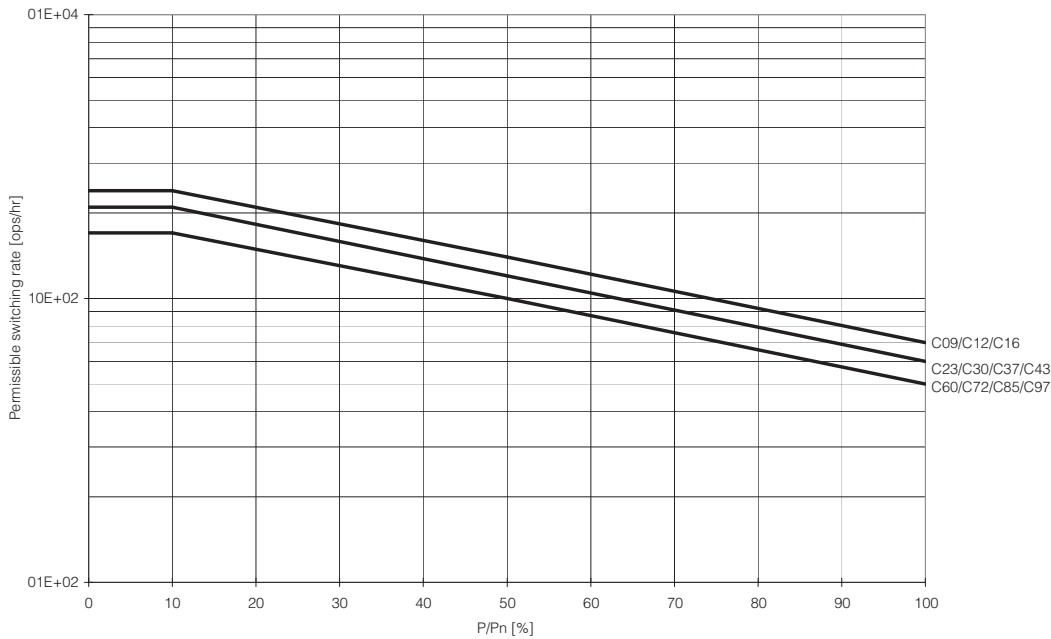

AC-4

Inching of squirrel-cage motors; $U_e = 230...460V$

Starting time $t_A = 0.25\text{ s}$

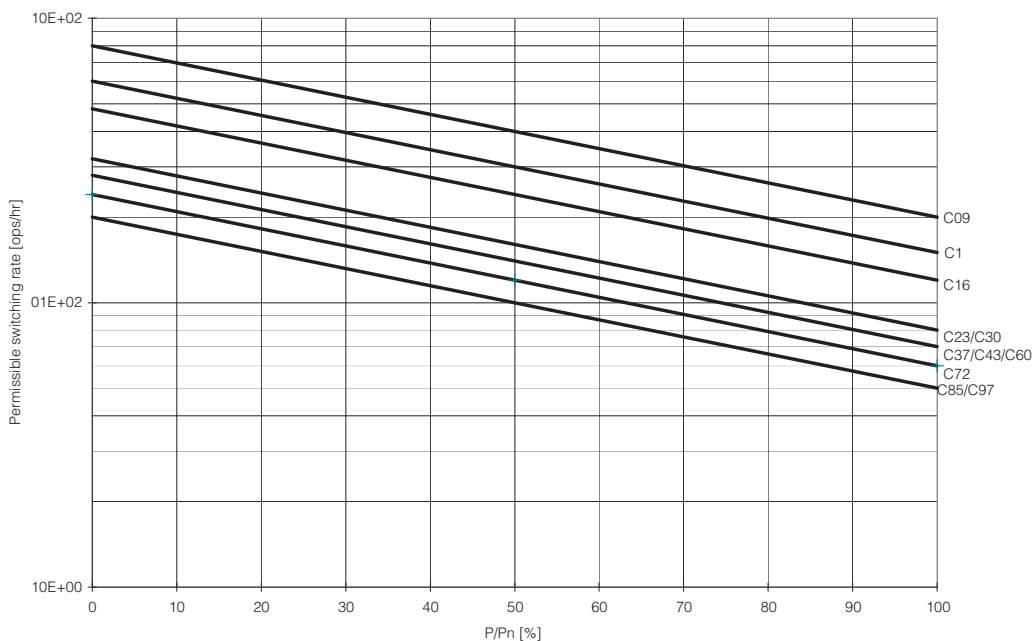

Bulletin 100-C/104-C
IEC Contactors
 Approximate Dimensions

Dimensions are shown in millimeters (inches). Dimensions are not intended for manufacturing purposes.

Bulletin 100-C Contactors and Accessories

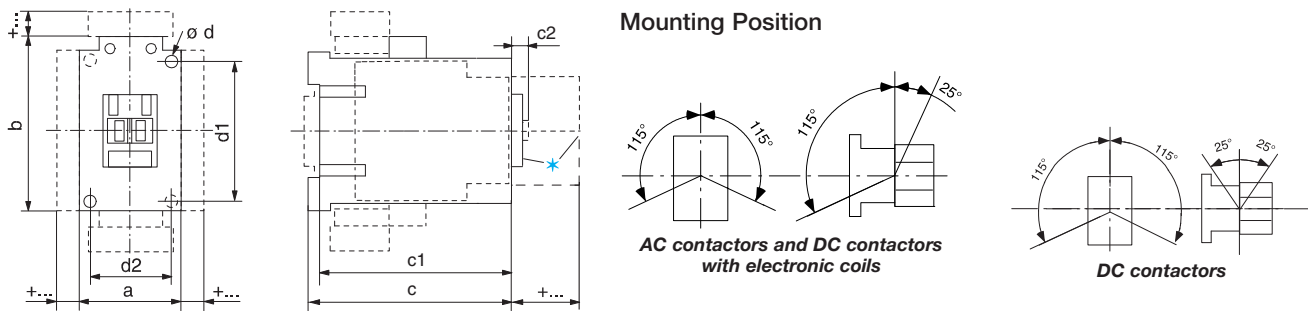

2

AC Contactors and DC Contactors with 12V or 24V Electronic Coils

Cat. No.	a	b	c	c1	c2	Ød	d1	d2
100-C09...100-C23	45 (1-25/32)	81 (3-3/16)	80.5 (3-11/64)	75.5 (2-31/32)	6 (15/64)	2 - 4.5 (2 -3/16)	60 (2-23/64)	35 (1-3/8)
100-C30, 100-C37	45 (1-25/32)	81 (3-3/16)	97.5 (4)	92.5 (3-41/64)	6.5 (1/4)	2 - 4.5 (2 -3/16)	60 (2-23/64)	35 (1-3/8)
100-C40	59 (2-21/64)	81 (3-3/16)	100.5 (3-61/64)	95.5 (3-49/64)	6.5 (1/4)	2 - 4.5 (2 -3/16)	60 (2-23/64)	45 (1-25/32)
100-C43	54 (2-1/8)	81 (3-3/16)	100.5 (3-61/64)	95.5 (3-49/64)	6.5 (1/4)	2 - 4.5 (2 -3/16)	60 (2-23/64)	45 (1-25/32)
100-C60...100-C97	72 (2-53/64)	122 (4-51/64)	117 (4-39/64)	111.5 (4-25/64)	8.5 (21/64)	4 - 5.4 (4 - 7/32)	100 (3-15/16)	55 (2-11/64)
100-C90	95 (3-47/64)	122 (4-51/64)	117 (4-39/64)	111.5 (4-25/64)	8.5 (21/64)	4 - 5.4 (4 - 7/32)	100 (3-15/16)	55 (2-11/64)

DC Contactors with Conventional Coils

Cat. No.	a	b	c	c1	c2	Ød	d1	d2
100-C09Z...100-C16Z	45 (1-25/32)	81 (3-3/16)	106.5 (4-3/16)	101.5 (4)	6 (15/64)	2 - 4.5 (2 -3/16)	60 (2-23/64)	35 (1-3/8)
100-C23Z	45 (1-25/32)	81 (3-3/16)	123.5 (4-55/64)	119 (4-43/64)	6 (15/64)	2 - 4.5 (2 -3/16)	60 (2-23/64)	35 (1-3/8)
100-C30Z...100-C37Z	45 (1-25/32)	81 (3-3/16)	141.5 (5-37/64)	136.5 (5-3/8)	6.5 (1/4)	2 - 4.5 (2 -3/16)	60 (2-23/64)	35 (1-3/8)
100-C40Z	59 (2-21/64)	81 (3-3/16)	144.5 (5-11/16)	139.5 (5-1/2)	6.5 (1/4)	2 - 4.5 (2 -3/16)	60 (2-23/64)	45 (1-25/32)
100-C43Z	54 (2-1/8)	81 (3-3/16)	144.5 (5-11/16)	139.5 (5-1/2)	6.5 (1/4)	2 - 4.5 (2 -3/16)	60 (2-23/64)	45 (1-25/32)
100-C60D...100-C97D	72 (2-53/64)	122 (4-51/64)	117 (4-39/64)	111.5 (4-25/64)	8.5 (21/64)	4 - 5.4 (4 - 7/32)	100 (3-15/16)	55 (2-11/64)
100-C90D	95 (3-47/64)	81 (3-3/16)	117 (4-39/64)	111.5 (4-25/64)	8.5 (21/64)	4 - 5.4 (4 - 7/32)	100 (3-15/16)	55 (2-11/64)

DC Contactors with 110V or 220V DC Electronic Coils

Cat. No.	a	b	c	c1	c2	Ød	d1	d2
100-C09E...100-C23E	45 (1-25/32)	105 (4-1/8)	80.5 (3-11/64)	75.5 (2-31/32)	6 (15/64)	2 - 4.5 (2 -3/16)	60 (2-23/64)	35 (1-3/8)
100-C30E...100-C37E	45 (1-25/32)	105 (4-1/8)	97.5 (4)	92.5 (3-41/64)	6.5 (1/4)	2 - 4.5 (2 -3/16)	60 (2-23/64)	35 (1-3/8)
100-C40EA...100-C40ED	59 (2-21/64)	105 (4-1/8)	100.5 (3-61/64)	95.5 (3-49/64)	6.5 (1/4)	2 - 4.5 (2 -3/16)	60 (2-23/64)	45 (1-25/32)
100-C43EA...100-C43ED	54 (2-1/8)	105 (4-1/8)	100.5 (3-61/64)	95.5 (3-49/64)	6.5 (1/4)	2 - 4.5 (2 -3/16)	60 (2-23/64)	45 (1-25/32)

Accessories

	Contactors with	mm	(inches)
Auxiliary contact block for front mounting	2- or 4-pole	c/c1 + 39	(c/c1 + 1-37/64)
Auxiliary contact block for side mounting	1- or 2-pole	a + 9	(a + 23/64)
Pneumatic Timing Module		c/c1 + 58	(c/c1 + 2-23/64)
Electronic Timing Module	on coil terminal side	b + 24	(b + 15/16)
Mechanical Interlock	on side of contactor	a + 9	(a + 23/64)
Mechanical Latch		c/c1 + 61	(c/c1 + 2-31/64)
Interface Module	on coil terminal side	b + 9	(b + 23/64)
Surge Suppressor	on coil terminal side	b + 3	(b + 1/8)
Labeling with *	label sheet	+ 0	(+ 0)
	marking tag sheet with clear cover	+ 0	(+ 0)
	marking tag adapter for System V4 / V5	+ 5.5	(+ 7/32)
	marking tag adapter for System Bul. 1492W	+ 5.5	(+ 7/32)
Terminal Lug Kit	100-C09...C23	b + 53	(b + 2-3/32)
	100-C30...37	b + 44	(b + 1-47/64)
	100-C43	b + 52	(b + 2-3/64)
	100-C60...C97	b + 99	(b + 3-7/8)
Paralleling Links	100-C09...C23	b + 78	(b + 3-1/16)
	100-C30...C37	c + 9/5	(c + 3/8)
		b + 85	(b + 3-11/32)

Motor Protection Circuit Breakers and Motor Circuit Protectors

Application Ratings

UL Listed Application Ratings - Motor Protection Circuit Breakers with Bulletin 100-C Contactors

Cat. No.	UL 508 Manual Motor Controller						UL 508 Type F Combination Motor Controller			UL 508 Type E Self-Protected Combination Motor Controller		
	Max. Fuse or C.B. per NEC	Minimum Contactor Size	Group Motor Installation		Motor Disconnect		Minimum Contactor Size	Max. Short Circuit Current [kA]		Minimum Contactor Size	Max. Short Circuit Current [kA]	
			480V	600V	480V	600V		480Y/277V§	600Y/347V§		480Y/277V§	600Y/347V§
C-Frame												
140M-C2E-A16	450	100-C09	65	47	65	47	100-C09	65	47	100-C09	65	47
140M-C2E-A25	450	100-C09	65	47	65	47	100-C09	65	47	100-C09	65	47
140M-C2E-A40	450	100-C09	65	47	65	47	100-C09	65	47	100-C09	65	47
140M-C2E-A63	450	100-C09	65	47	65	47	100-C09	65	47	100-C09	65	47
140M-C2E-B10	450	100-C09	65	47	65	47	100-C09	65	47	100-C09	65	47
140M-C2E-B16	450	100-C09	65	47	65	47	100-C09	65	47	100-C09	65	47
140M-C2E-B25	450	100-C09	65	30	65	30	100-C09	65	30	100-C09	65	30
140M-C2E-B40	450	100-C09	65	30	65	30	100-C09	65	30	—	65	25
140M-C2E-B63	450	100-C09	65	30	65	30	100-C09	65	—	—	65	—
140M-C2E-C10	450	100-C09	65	30	65	30	100-C09	65	—	—	65	—
140M-C2E-C16	450	100-C12	30	30	30	25	100-C12	30	—	—	30	—
140M-C2E-C20	450	100-C16	30	30	30	30	100-C23	10	—	—	10	—
140M-C2E-C25	450	100-C23	30	30	10	10	—	—	—	—	—	—
	450	100-C30	30	30	30	30	—	—	—	—	—	—
140M-C2E-C29	450	100-C30	10	5	10	5	—	—	—	—	—	—
140M-C2E-C32	450	100-C37	10	5	10	5	—	—	—	—	—	—
D-Frame												
140M-D8E-B25	450	100-C09	65	30	65	30	100-C09	65	30	100-C09	65	30
	—	—	—	—	—	—	—	—	—	100-C23	65	30
140M-D8E-B40	450	100-C09	65	30	65	30	100-C09	65	30	100-C23	65	30
140M-D8E-B63	450	100-C09	65	30	65	30	100-C09	65	30	100-C30	65	30
140M-D8E-C10	450	100-C09	65	30	65	30	100-C09	65	30	100-C30	65	30
140M-D8E-C16	450	100-C12	65	30	65	30	100-C12	65	30	100-C30	65	30
140M-D8E-C20	450	100-C23	65	30	65	30	100-C23	65	—	100-C30	65	—
140M-D8E-C25	450	100-C23	65	30	65	30	100-C23	30	—	100-C30	30	—
140M-D8E-C29	450	100-C30	65	10	65	10	—	—	—	—	—	—
140M-D8E-C32	450	100-C37	65	10	65	10	—	—	—	—	—	—
F-Frame												
140M-F8E-C10	600	100-C30	65	30	65	30	100-C30	65	30	100-C30	65	30
140M-F8E-C16	600	100-C30	65	30	65	30	100-C30	65	30	100-C30	65	30
140M-F8E-C20	600	100-C30	65	30	65	30	100-C30	65	30	100-C30	65	30
140M-F8E-C25	600	100-C30	65	30	65	30	100-C30	65	30	100-C30	65	30
140M-F8E-C32	600	100-C30	65	30	65	30	100-C30	65	30	100-C30	65	30
140M-F8E-C45	600	100-C37	65	18	65	18	100-C37	65	—	100-C37	65	—
CMN-Frame												
140-CMN-2500	1000	100-C16	65	42	—	—	—	—	—	—	—	—
140-CMN-4000	1000	100-C30	65	42	—	—	—	—	—	—	—	—
140-CMN-6300	1000	100-C43	42	18	—	—	—	—	—	—	—	—
140-CMN-9000	1000	100-C72	35	10	—	—	—	—	—	—	—	—

§ For full voltage (delta) ratings above 277V or 347V, follow the NEC or CEC rules for group motor applications.

2



Motor Protection Circuit Breakers and Motor Circuit Protectors

Application Ratings

UL Listed Application Ratings - Motor Circuit Protectors with Bulletin 100-C Contactors§

Cat. No.	UL 508 Manual Motor Controller						UL 508 Type E (Self-Protected) Combination Motor Controller		
	Max. Fuse or C.B. per NEC	Minimum Contactor Size	Group Motor Installation		Motor Disconnect		Minimum Contactor Size	Max. Short Circuit Current [kA] 480Y/277V*	Max. Short Circuit Current [kA] 600Y/347V*
			Max. Short Circuit Current [kA]		Max. Short Circuit Current [kA]				
			480V	600V	480V	600V			
C-Frame									
140M-C2N-A16	450	100-C09	65	47	65	47	100-C09	65	47
140M-C2N-A25	450	100-C09	65	47	65	47	100-C09	65	47
140M-C2N-A40	450	100-C09	65	47	65	47	100-C09	65	47
140M-C2N-A63	450	100-C09	65	47	65	47	100-C09	65	47
140M-C2N-B10	450	100-C09	65	47	65	47	100-C09	65	47
140M-C2N-B16	450	100-C09	65	47	65	47	100-C09	65	47
140M-C2N-B25	450	100-C09	65	30	65	30	100-C09	65	—
D-Frame									
140M-D8N-B25	450	100-C09	65	30	65	30	100-C09	65	—
	—	—	—	—	—	—	100-C23	65	30
140M-D8N-B40	450	100-C09	65	30	65	30	100-C23	65	30
140M-D8N-B63	450	100-C09	65	30	65	30	100-C30	65	30
140M-D8N-C10	450	100-C09	65	30	65	30	100-C30	65	30
140M-D8N-C16	450	100-C12	65	30	65	30	100-C30	65	30
140M-D8N-C25	450	100-C23	30	30	30	30	100-C30	65	—
140M-D8N-C32	450	100-C37	65	10	65	10	—	—	—
F-Frame									
140M-F8N-C25	600	100-C23	65	30	65	30	100-C30	65	30
140M-F8N-C32	600	100-C30	65	30	65	30	100-C30	65	30
140M-F8N-C45	600	100-C37	65	18	65	18	100-C37	65	—

§ Separate overload protection is required.

* For full-voltage (delta) ratings above 277V or 347V, follow the NEC or CEC rules for group motor applications.

2

Definition of Type 2 Short Circuit Coordination:

- The contactor or starter must not endanger persons or plant in the event of a short circuit.
- No damage to the motor protection device or other parts may occur with the exception of welding of the contactor or starter contacts if these can be easily separated without appreciable deformation (such as with a screwdriver).

In the event of short circuit, fast-opening, current-limiting Bulletin 140M Motor Protection Circuit Breakers make it possible to build economical, fully short-circuit coordinated starter combinations with Type 2 coordination.

Type 2 Coordination 400V

Cat. No.			Max. Short Circuit Current [kA]	For Use With Contactors Below (or larger)
Standard Motor Protection	High Inrush Motor Protection	Motor Circuit Protection	400V	
C-Frame				
140M-C2E-A16	—	140M-C2N-A16	100	100-C09
140M-C2E-A25	140M-C2T-A16	140M-C2N-A25	100	100-C09
140M-C2E-A40	140M-C2T-A25	140M-C2N-A40	100	100-C09
140M-C2E-A63	140M-C2T-A40	140M-C2N-A63	100	100-C09
140M-C2E-B10	140M-C2T-A63	140M-C2N-B10	100	100-C09
140M-C2E-B16	140M-C2T-B10	140M-C2N-B16	100	100-C09
140M-C2E-B25	140M-C2T-B16	140M-C2N-B25	50	100-C09
140M-C2E-B40	140M-C2T-B25	—	50	100-C09
140M-C2E-B63	140M-C2T-B40	—	50	100-C09
140M-C2E-C10	140M-C2T-B63	—	50	100-C09
140M-C2E-C16	140M-C2T-C10	—	50	100-C12*
140M-C2E-C20	140M-C2T-C16	—	50	100-C23
140M-C2E-C25	—	—	15	100-C30
140M-C2E-C29	—	—	15	100-C30
140M-C2E-C32	—	—	15	100-C37
D-Frame				
140M-D8E-B25	—	140M-D8N-B25	100	100-C09
140M-D8E-B40	—	140M-D8N-B40	100	100-C09
140M-D8E-B63	—	140M-D8N-B63	100	100-C09
140M-D8E-C10	—	140M-D8N-C10	65	100-C09
140M-D8E-C16	—	140M-D8N-C16	65	100-C12
140M-D8E-C20	140M-D8T-C16	—	65	100-C23
140M-D8E-C25	140M-D8T-C20	140M-D8N-C25	50	100-C23
140M-D8E-C29	—	—	65	100-C30
140M-D8E-C32	—	140M-D8N-C32	65	100-C37
F-Frame				
140M-F8E-C10	—	—	100	100-C09
140M-F8E-C16	—	—	100	100-C12
140M-F8E-C20	—	—	100	100-C23
140M-F8E-C25	—	140M-F8N-C25	100	100-C30
140M-F8E-C32	140M-F8T-C25	140M-F8N-C32	100	100-C30
140M-F8E-C45	140M-F8T-C32	140M-F8N-C45	100	100-C37
CMN-Frame				
140-CMN-2500	—	—	65	100-C16
140-CMN-4000	—	—	65	100-C30
140-CMN-6300	—	—	42	100-C43
140-CMN-9000	—	—	35	100-C72

* Cat. No. 100-C16 contactors Type 1 only

Type 2 Coordination 480V

Cat. No.			Max. Short Circuit Current [kA]	For Use With Contactors Below (or larger)
Standard Motor Protection	High Inrush Motor Protection	Motor Circuit Protection		
C-Frame				
140M-C2E-A16	—	140M-C2N-A16	65	100-C09
140M-C2E-A25	140M-C2T-A16	140M-C2N-A25	65	100-C09
140M-C2E-A40	140M-C2T-A25	140M-C2N-A40	65	100-C09
140M-C2E-A63	140M-C2T-A40	140M-C2N-A63	65	100-C09
140M-C2E-B10	140M-C2T-A63	140M-C2N-B10	65	100-C09
140M-C2E-B16	140M-C2T-B10	140M-C2N-B16	65	100-C09
140M-C2E-B25	140M-C2T-B16	140M-C2N-B25	50	100-C16
140M-C2E-B40	140M-C2T-B25	—	50	100-C30
140M-C2E-B63	140M-C2T-B40	—	50	100-C30
140M-C2E-C10	140M-C2T-B63	—	50	100-C30
140M-C2E-C16	140M-C2T-C10	—	10	100-C30
140M-C2E-C20	140M-C2T-C16	—	10	100-C30
140M-C2E-C25	—	—	10	100-C30
140M-C2E-C29	—	—	10	100-C30
140M-C2E-C32	—	—	10	100-C37
D-Frame				
140M-D8E-B25	—	140M-D8N-B25	65	100-C09
140M-D8E-B40	—	140M-D8N-B40	65	100-C09
140M-D8E-B63	—	140M-D8N-B63	65	100-C09
140M-D8E-C10	—	140M-D8N-C10	65	100-C09
140M-D8E-C16	—	140M-D8N-C16	65	100-C12
140M-D8E-C20	140M-D8T-C16	—	65	100-C23
140M-D8E-C25	140M-D8T-C20	140M-D8N-C25	65	100-C23
140M-D8E-C29	—	—	65	100-C30
140M-D8E-C32	—	140M-D8N-C32	65	100-C37
F-Frame				
140M-F8E-C10	—	—	65	100-C09
140M-F8E-C16	—	—	65	100-C12
140M-F8E-C20	—	—	65	100-C23
140M-F8E-C25	—	140M-F8N-C25	65	100-C30
140M-F8E-C32	140M-F8T-C25	140M-F8N-C32	65	100-C30
140M-F8E-C45	140M-F8T-C32	140M-F8N-C45	65	100-C37
CMN-Frame				
140-CMN-2500	—	—	65	100-C16
140-CMN-4000	—	—	65	100-C30
140-CMN-6300	—	—	42	100-C43
140-CMN-9000	—	—	35	100-C72



Motor Circuit Protectors

Application Ratings

Type 2 Coordination 600V

Cat. No.			Max. Short Circuit Current [kA]	For Use With Contactors Below (or larger)
Standard Motor Protection	High Inrush Motor Protection	Motor Circuit Protection		
C-Frame				
140M-C2E-A16	—	140M-C2N-A16	47	100-C09
140M-C2E-A25	140M-C2T-A16	140M-C2N-A25	47	100-C09
140M-C2E-A40	140M-C2T-A25	140M-C2N-A40	47	100-C09
140M-C2E-A63	140M-C2T-A40	140M-C2N-A63	47	100-C09
140M-C2E-B10	140M-C2T-A63	140M-C2N-B10	47	100-C09
140M-C2E-B16	140M-C2T-B10	140M-C2N-B16	47	100-C09
140M-C2E-B25	140M-C2T-B16	140M-C2N-B25	10	100-C16
140M-C2E-B40	140M-C2T-B25	—	10	100-C16
140M-C2E-B63	140M-C2T-B40	—	5	100-C23
140M-C2E-C10	140M-C2T-B63	—	5	100-C30
140M-C2E-C16	140M-C2T-C10	—	5	100-C30
140M-C2E-C20	140M-C2T-C16	—	5	100-C30
140M-C2E-C25	—	—	5	100-C30
140M-C2E-C29	—	—	5	100-C30
140M-C2E-C32	—	—	5	100-C37
D-Frame				
140M-D8E-B25	—	140M-D8N-B25	30	100-C30
140M-D8E-B40	—	140M-D8N-B40	30	100-C30
140M-D8E-B63	—	140M-D8N-B63	30	100-C30
140M-D8E-C10	—	140M-D8N-C10	30	100-C30
140M-D8E-C16	—	140M-D8N-C16	30	100-C30
140M-D8E-C20	140M-D8T-C16	—	5	100-C30
140M-D8E-C25	140M-D8T-C20	140M-D8N-C25	5	100-C30
140M-D8E-C29	—	—	10	100-C30
140M-D8E-C32	—	140M-D8N-C32	10	100-C37
F-Frame				
140M-F8E-C10	—	—	30	100-C30
140M-F8E-C16	—	—	30	100-C30
140M-F8E-C20	—	—	30	100-C30
140M-F8E-C25	—	140M-F8N-C25	30	100-C30
140M-F8E-C32	140M-F8T-C25	140M-F8N-C32	30	100-C30
140M-F8E-C45	140M-F8T-C32	140M-F8N-C45	10	100-C37
CMN-Frame				
140-CMN-2500	—	—	42	100-C16
140-CMN-4000	—	—	42	100-C30
140-CMN-6300	—	—	18	100-C43
140-CMN-9000	—	—	10	100-C72