

XS608B1DBL2

inductive sensor XS6 M8 - L51mm - stainless - Sn2.5mm - 12..48VDC - cable 2m



Product availability: Non-Stock - Not normally stocked in distribution facility



Main

Range of product	OsiSense XS
Series name	General purpose
Sensor type	Inductive proximity sensor
Device application	-
Sensor name	XS6
Sensor design	Cylindrical M8
Size	51 mm
Body type	Fixed
Detector flush mounting acceptance	Flush mountable
Material	Stainless steel
Type of output signal	Discrete
Wiring technique	2-wire
[Sn] nominal sensing distance	0.10 in (2.5 mm)
Discrete output function	1 NC
Output circuit type	DC
Electrical connection	Cable
Cable length	6.56 ft (2 m)
[Us] rated supply voltage	12...48 V DC reverse polarity protection
Switching capacity in mA	<= 100 mA DC overload and short-circuit protection
IP degree of protection	IP67 IEC 60529

Complementary

Thread type	M8 x 1
Detection face	Frontal
Front material	PPS
Enclosure material	Stainless steel 303
Operating zone	0.00...0.08 in (0...2 mm)
Differential travel	1...15% of Sr
Cable composition	2 x 0.11 mm ²
Wire insulation material	PvR
Status LED	Output state 1 LED yellow)
Supply voltage limits	10...58 V DC
Switching frequency	<= 3000 Hz DC
Maximum voltage drop	<4 V closed)
Maximum delay first up	10 ms
Maximum delay response	0.3 ms
Maximum delay recovery	0.3 ms
Marking	CE
Threaded length	1.65 in (42 mm)
Length	2.01 in (51 mm)
Net weight	0.08 lb(US) (0.035 kg)

The information provided in this documentation contains general descriptions and/or technical characteristics of the performance of the products contained herein. This documentation is not intended as a substitute for and is not to be used for determining suitability or reliability of these products for specific user applications. It is the duty of any such user or integrator to perform the appropriate and complete risk analysis, evaluation and testing of the products with respect to the relevant specific application or use thereof. Neither Schneider Electric Industries SAS nor any of its affiliates or subsidiaries shall be responsible or liable for misuse of the information contained herein.

Environment

Product certifications	CSA UL
Ambient air temperature for operation	-13...158 °F (-25...70 °C)
Ambient air temperature for storage	-40...185 °F (-40...85 °C)
Vibration resistance	25 gn +/- 2 mm 10...55 Hz)IEC 60068-2-6
Shock resistance	50 gn 11 ms IEC 60068-2-27

Ordering and shipping details

Category	22486 - SENSORS, PROXIMITY
Discount Schedule	DS2
GTIN	03389119045711
Package weight(Lbs)	0.04 kg (0.08 lb(US))
Returnability	No
Country of origin	FR

Offer Sustainability

Sustainable offer status	Green Premium product
REACH Regulation	REACH Declaration
EU RoHS Directive	Pro-active compliance (Product out of EU RoHS legal scope) EU RoHS Declaration
Mercury free	Yes
RoHS exemption information	Yes
Environmental Disclosure	Product Environmental Profile
Circularity Profile	End Of Life Information

Contractual warranty

Warranty	18 months
----------	-----------

Dimensions

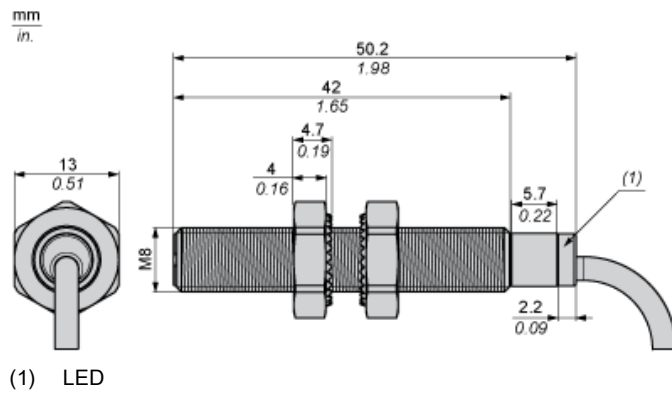

Minimum Mounting Distances in mm

Side by side

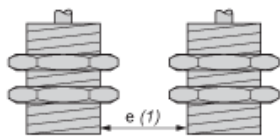

e (1) 5 mm/0.20 in.

≥

Face to face

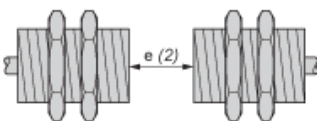

e (2) 30 mm/1.18 in.

≥

Facing a metal object

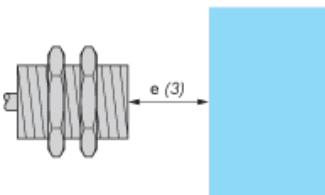

e (3) 8 mm/0.31 in.

≥

Mounting

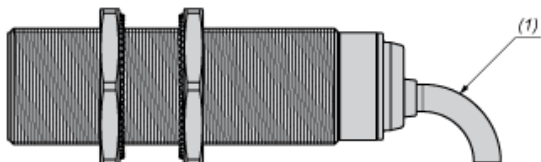

(1) Bending cable: 4 x external cable diameter

Wiring Schemes

2-Wire Non-polarised

NC output

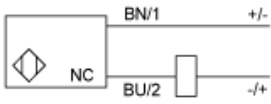

BU : Blue
BN : Brown

Performance Curves

Standard Steel Target (mm) : 8x8x1

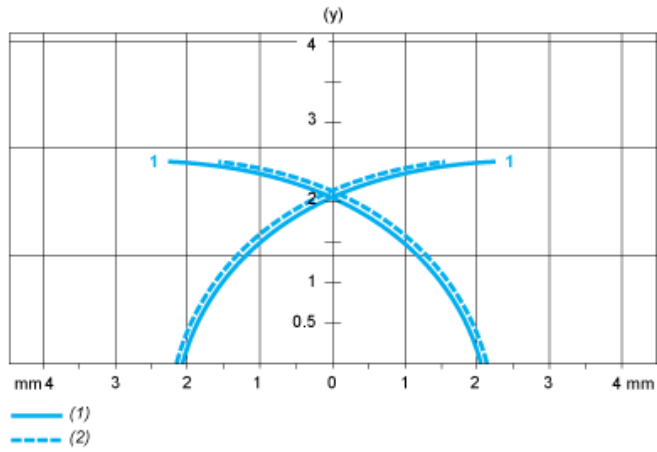

- (1) Pick-up points
- (2) Drop-out points (object approaching from the side)
- (y) Sensing distance in mm