



HR-1 PAR38 FULL CUP HOLDER WITH MOUNTING COVER

The HR-1 is a rugged deluxe full cup PAR38 incandescent flood holder with mounting cover, rated up to 150 watts. The HR-1 is made from die cast aluminum. Ideal for use on sides of buildings to provide perimeter lighting. Can also be used with Rab Design outdoor Sensors.

HOUSING Die cast aluminum with a powder coat paint finish.

SOCKET Medium base porcelain socket.

SWIVEL Fully adjustable with serrated teeth for locking in place. 1/2" NPS threaded arm with locking nut. Mounts to standard covers.

GASKET Silicone gasket.

LAMP Not included.

COVER Die cast aluminum with threaded centre hole. Cover has matching finish.

FINISH All units have a powder coat paint finish. Standard colours are Silver/Grey, Black, Architectural Bronze and White. Custom colours are available, Please consult factory.

ACCESSORIES HR KIT glass lens and any outdoor sensor from Rab Design.

APPROVAL cULus



Catalog Code

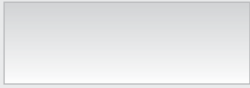

HR-1 - SILVER GREY
HRB-1 - BLACK
HRR-1 - ARCHITECTURAL
BRONZE
HRW-1 - WHITE

LAMPS NOT INCLUDED

RAB DESIGN



Dimensions

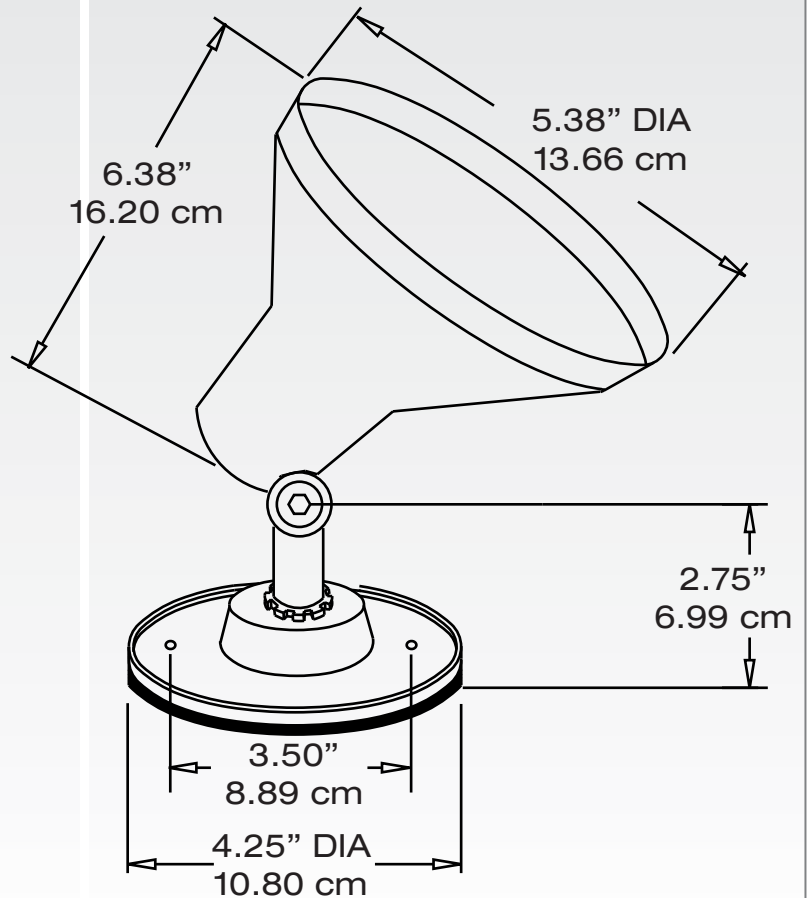

www.rabdesign.ca