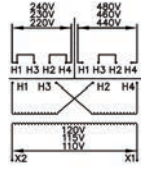
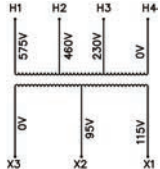
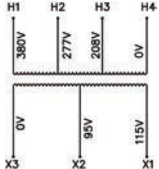
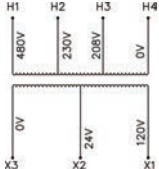
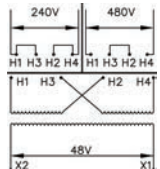

Machine Tool Transformers

Product Selection

Note: Refer to 8-47 for information on how to select a machine tool transformer.

Transformer without Primary or Secondary Fuse Block/Clip‡

Continuous VA	Cat. Nos.				
	Primary 220x440V, 230x460V, 240x480V (50/60 Hz) 	Primary 230/460/575V (50/60 Hz) 	Primary 208/277/380V (50/60 Hz) 	Primary 208/230/480V (50/60 Hz) 	Primary 240x480V (50/60 Hz) 
	Secondary 110, 115, 120V	Secondary 115/95V	Secondary 115/95V	Secondary 120/24V	Secondary 48V
50	1497A-A1-M6-0-N	1497A-A1-M7-0-N	1497A-A1-M8-0-N	1497A-A1-M18-0-N	1497A-A1-M19-0-N
75	1497A-A2-M6-0-N	1497A-A2-M7-0-N	1497A-A2-M8-0-N	1497A-A2-M18-0-N	1497A-A2-M19-0-N
100	1497A-A3-M6-0-N	1497A-A3-M7-0-N	1497A-A3-M8-0-N	1497A-A3-M18-0-N	1497A-A3-M19-0-N
150	1497A-A4-M6-0-N	1497A-A4-M7-0-N	1497A-A4-M8-0-N	1497A-A4-M18-0-N	1497A-A4-M19-0-N
200	1497A-A5-M6-0-N	1497A-A5-M7-0-N	1497A-A5-M8-0-N	1497A-A5-M18-0-N	1497A-A5-M19-0-N
250	1497A-A6-M6-0-N	1497A-A6-M7-0-N	1497A-A6-M8-0-N	1497A-A6-M18-0-N	1497A-A6-M19-0-N
300	1497A-A7-M6-0-N	1497A-A7-M7-0-N	1497A-A7-M8-0-N	1497A-A7-M18-0-N	1497A-A7-M19-0-N
350	1497A-A8-M6-0-N	1497A-A8-M7-0-N	1497A-A8-M8-0-N	1497A-A8-M18-0-N	1497A-A8-M19-0-N
500	1497A-A9-M6-0-N	1497A-A9-M7-0-N	1497A-A9-M8-0-N	—	1497A-A9-M19-0-N
750	1497A-A10-M6-0-N	1497A-A10-M7-0-N	1497A-A10-M8-0-N	—	1497A-A10-M19-0-N
1000	1497A-A11-M6-0-N	1497A-A11-M7-0-N	1497A-A11-M8-0-N	—	1497A-A11-M19-0-N
1500	1497A-A12-M6-0-N	1497A-A12-M7-0-N	1497A-A12-M8-0-N	—	—
2000	1497A-A13-M6-0-N	1497A-A13-M7-0-N	1497A-A13-M8-0-N	—	—
3000	1497A-A14-M6-0-N	—	—	—	—

Transformer with 1 Secondary Fuse Block/Clip‡

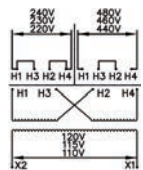
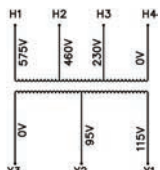
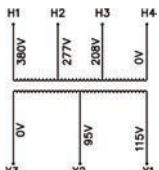
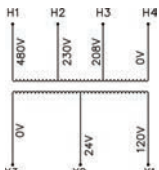
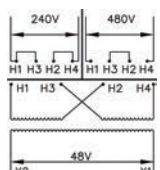
Continuous VA	Cat. Nos.				
	Primary 220x440V, 230x460V, 240x480V (50/60 Hz) 	Primary 230/460/575V (50/60 Hz) 	Primary 208/277/380V (50/60 Hz) 	Primary 208/230/480V (50/60 Hz) 	Primary 240x480V (50/60 Hz) 
	Secondary 110, 115, 120V	Secondary 115/95V	Secondary 115/95V	Secondary 120/24V	Secondary 48V
50	1497A-A1-M6-1-N	1497A-A1-M7-1-N	1497A-A1-M8-1-N	1497A-A1-M18-1-N	1497A-A1-M19-1-N
75	1497A-A2-M6-1-N	1497A-A2-M7-1-N	1497A-A2-M8-1-N	1497A-A2-M18-1-N	1497A-A2-M19-1-N
100	1497A-A3-M6-1-N	1497A-A3-M7-1-N	1497A-A3-M8-1-N	1497A-A3-M18-1-N	1497A-A3-M19-1-N
150	1497A-A4-M6-1-N	1497A-A4-M7-1-N	1497A-A4-M8-1-N	1497A-A4-M18-1-N	1497A-A4-M19-1-N
200	1497A-A5-M6-1-N	1497A-A5-M7-1-N	1497A-A5-M8-1-N	1497A-A5-M18-1-N	1497A-A5-M19-1-N
250	1497A-A6-M6-1-N	1497A-A6-M7-1-N	1497A-A6-M8-1-N	1497A-A6-M18-1-N	1497A-A6-M19-1-N
300	1497A-A7-M6-1-N	1497A-A7-M7-1-N	1497A-A7-M8-1-N	1497A-A7-M18-1-N	1497A-A7-M19-1-N
350	1497A-A8-M6-1-N	1497A-A8-M7-1-N	1497A-A8-M8-1-N	1497A-A8-M18-1-N	1497A-A8-M19-1-N
500	1497A-A9-M6-1-N	1497A-A9-M7-1-N	1497A-A9-M8-1-N	—	1497A-A9-M19-1-N
750	1497A-A10-M6-1-N	1497A-A10-M7-1-N	1497A-A10-M8-1-N	—	1497A-A10-M19-1-N
1000	1497A-A11-M6-1-N	1497A-A11-M7-1-N	1497A-A11-M8-1-N	—	1497A-A11-M19-1-N
1500	1497A-A12-M6-1-N	1497A-A12-M7-1-N	1497A-A12-M8-1-N	—	—
2000	1497A-A13-M6-1-N	1497A-A13-M7-1-N	1497A-A13-M8-1-N	—	—
3000	1497A-A14-M6-1-N	—	—	—	—

‡ Secondary Fuse Block/Clip: Transformers rated 350VA and below use secondary fuse clips. Transformers rated 500VA and above use secondary fuse blocks.



Dimensions are shown in inches (millimeters). Dimensions are not intended to be used for manufacturing purposes.

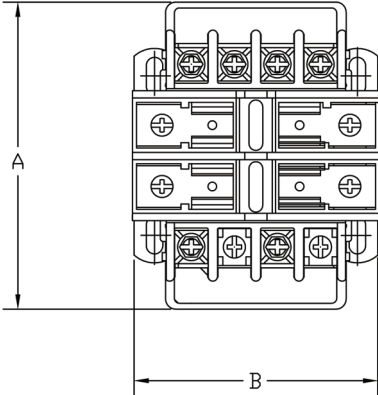

Transformer with 2 Primary Fuse Blocks and 0 or 1 Secondary Fuse Block/Clip (Top View)

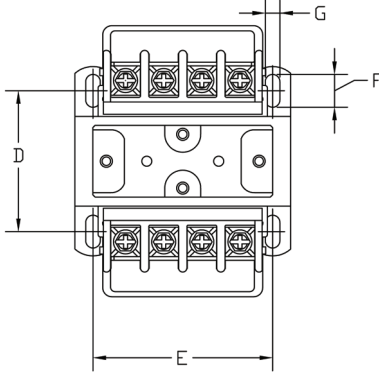

Transformer with 0 Primary Fuse Blocks and 0 or 1 Secondary Fuse Block/Clip (Top View)

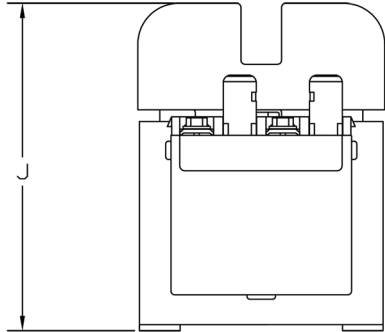

Transformer with 2 Primary Fuse Blocks and 1 Secondary Fuse Block/Clip (Side View)

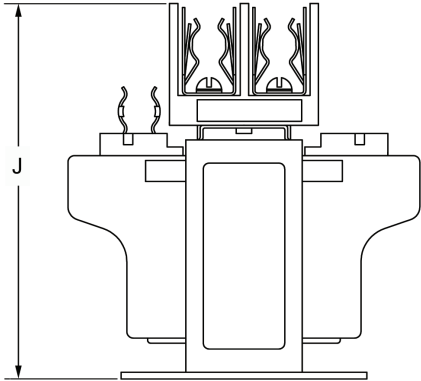

Transformer with 2 Primary Fuse Blocks and 1 Secondary Fuse Block/Clip (Side View)

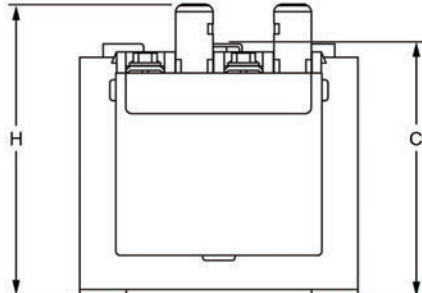

Transformer with 0 Primary Fuse Block and Secondary Fuse Block/Clip (Side View)

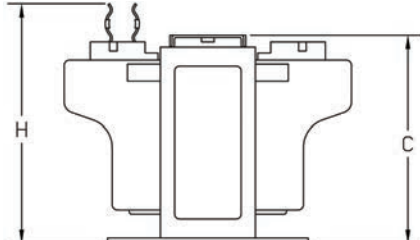

Transformer with 0 Primary Fuse Blocks and 1 Secondary Fuse Block/Clip (Side View)

VA	Cat. No.	A	B	C	D	E	F	G	H	J	Approx. Shipping Wt. lb (kg)
50	1497A-A1-M6-__-N	3-25/32 (96)	3 (76)	2-23/32 (69)	1-31/32 (50)	2-1/2 (64)	15/32 (12)	1/5 (5)	3-9/64 (80)	4-1/32 (102)	3 (1.4)
	1497A-A1-M7-__-N	4-1/32 (102)			2-1/5 (56)						4 (1.8)
	1497A-A1-M8-__-N	4-17/32 (115)			2-53/64 (72)						4 (1.8)
	1497A-A1-M18-__-N	3-25/32 (96)			1-31/32 (50)						4 (1.8)
	1497A-A1-M19-__-N	4-1/32 (102)			2-27/64 (61)						
75	1497A-A2-M6-__-N	4-1/32 (102)	3 (76)	2-23/32 (69)	2-27/64 (61)	2-1/2 (64)	15/32 (12)	1/5 (5)	3-9/64 (80)	4-1/32 (102)	4 (1.8)
	1497A-A2-M7-__-N	4-17/32 (115)			2-5/8 (67)						5 (2.3)
	1497A-A2-M8-__-N	3-3/8 (86)	3-3/64 (77)	3 (76)	2-13/16 (71)	3-15/32 (88)			4-23/64 (110)	5 (2.3)	
	1497A-A2-M18-__-N	3 (76)	2-23/32 (69)	2-27/64 (61)	2-1/2 (64)	3-9/64 (80)			4-1/32 (102)	5 (2.3)	
	1497A-A2-M19-__-N	4-1/32 (102)	2-23/32 (69)	2-27/64 (61)	2-1/2 (64)	3-9/64 (80)			4-1/32 (102)	5 (2.3)	
100	1497A-A3-M6-__-N	4 (102)	3-3/8 (86)	3-3/64 (77)	2-27/64 (61)	2-13/16 (71)	15/32 (12)	1/5 (5)	3-15/32 (88)	4-23/64 (110)	5 (2.3)
	1497A-A3-M7-__-N	4-1/16 (103)	3-3/4 (95)	3-23/64 (85)	2-13/16 (71)	3-5/16 (80)			3-49/64 (96)	4-21/32 (118)	6 (2.7)
	1497A-A3-M8-__-N	4-17/32 (115)			3 (76)				6 (2.7)		
	1497A-A3-M18-__-N	4 (102)	3-3/8 (86)	3-3/64 (77)	2-27/64 (61)	2-13/16 (71)			3-15/32 (88)	4-23/64 (110)	6 (2.7)
	1497A-A3-M19-__-N	4 (102)	3-3/8 (86)	3-3/64 (77)	2-27/64 (61)	2-13/16 (71)			3-15/32 (88)	4-23/64 (110)	6 (2.7)