

specifications

Net-Verse™ Cabinets shall consist of a welded and assembled steel frame construction available in 600mm (23.6") and 800mm (31.5") widths, 1000mm (39.4") and 1200mm (47.3") depths, and 42 RU, 45 RU, and 48 RU heights. Cabinet shall include curved perforated front single hinge doors with 69% air flow rate and split rear perforated doors. Cabinet shall have two horizontal locking side panels on each side or optional as an accessory. The cabinet shall have fully adjustable front and rear equipment rails. 800mm wide cabinet comes with provisions for front or rear cable management fingers and brackets that are available as an accessory. 800mm wide cabinets shall have vertical blanking panel with (4) 1 RU vertical pass throughs and cover plates. The top of cabinet includes brush cable entry points to prevent air leakage. Cabinet shall have optional bottom panels with brush cable entry points and cover plates for effective air sealing. Cabinet shall have two full height PDU/cable management brackets, one on each side. The entire cabinet shall be fully electrically bonded, including equipment rails, doors, and side panels. The cabinet comes equipped with the necessary brackets and hardware to gang adjoining Net-Verse™ Cabinets. Cabinet shall have 1,360kg (3,300 lbs.) static load rating and 500kg (1,100 lbs.) rolling load rating.



technical information

Dimensions:	600mm W (23.6") x 1000mm D (39.4") x 2045mm H (80.5")
	600mm W (23.6") x 1000mm D (39.4") x 2178mm H (85.8")
	600mm W (23.6") x 1200mm D (47.3") x 2045mm H (80.5")
	600mm W (23.6") x 1200mm D (47.3") x 2178mm H (85.8")
	600mm W (23.6") x 1000mm D (39.4") x 2311mm H (91.1")
	600mm W (23.6") x 1200mm D (47.3") x 2311mm H (91.1")
	800mm W (31.5") x 1000mm D (39.4") x 2045mm H (80.5")
	800mm W (31.5") x 1000mm D (39.4") x 2178mm H (85.8")
	800mm W (31.5") x 1200mm D (47.3") x 2045mm H (80.5")
	800mm W (31.5") x 1200mm D (47.3") x 2178mm H (85.8")
	800mm W (31.5") x 1000mm D (39.4") x 2311mm H (91.1")
	800mm W (31.5") x 1200mm D (47.3") x 2311mm H (91.1")
Material:	Steel with durable black or white powder coat finish
Compliance:	EIA-310-E TIA/EIA-942
Packaging:	Cabinet ships assembled, one per pallet

Net-Verse™ Cabinets

		800mm Width	600mm Width	
With Side Panels	42 RU	DN8212*	DN6212*	1000mm Depth
	45 RU	DN8512*	DN6512*	
	48 RU	DN8812*	DN6812*	
	42 RU	DN8222*	DN6222*	1200mm Depth
	45 RU	DN8522*	DN6522*	
	48 RU	DN8822*	DN6822*	
Without Side Panels	42 RU	DN8219*	DN6219*	1000mm Depth
	45 RU	DN8519*	DN6519*	
	48 RU	DN8819*	DN6819*	
	42 RU	DN8229*	DN6229*	1200mm Depth
	45 RU	DN8529*	DN6529*	
	48 RU	DN8829*	DN6829*	

*Available in Black (B) or White (W)

key features and benefits

Doors	Curved perforated front single hinge doors with 69% air flow rate with two point locking system; perforated split hinge rear doors with three point locking system
Equipment rails	Fully adjustable equipment rails with RU markings to ensure correct location of IT equipment
Universal PDU brackets	Full height PDU brackets with provisions for securing and bundling cables
Horizontally split locking side panels	Provide easy secured access to installed equipment
Modular cable management fingers (Optional, for 800mm only)	Provides bend radius control for each rack unit and can be positioned where required on cabinet posts for cable protection for increased network availability; provides design flexibility, scalability, and improved aesthetics for easier moves, adds, and changes
Durable coating	Cabinets are powder coated in a durable, low maintenance paint in black (RAL 9005) or white (RAL 9003)

applications

Net-Verse™ Cabinets are the preferred choice for applications that require maximum flexibility and the capacity to manage high cable density in data center, enterprise or co-location deployment. Net-Verse™ Cabinets are also compatible with Panduit cable management accessories and the Net-Contain™ Universal Aisle Containment System.

Front Door	
42 RU x 600mm	D62FD*
45 RU x 600mm	D65FD*
48 RU x 600mm	D68FD*
42 RU x 800mm	D82FD*
45 RU x 800mm	D85FD*
48 RU x 800mm	D88FD*
Rear Door	
42 RU x 600mm	D62RD*
45 RU x 600mm	D65RD*
48 RU x 600mm	D68RD*
42 RU x 800mm	D82RD*
45 RU x 800mm	D85RD*
48 RU x 800mm	D88RD*
Side Panels	
42 RU x 1000mm:	D21SP*
42 RU x 1200mm:	D22SP*
45 RU x 1000mm:	D51SP*
45 RU x 1200mm:	D52SP*
48 RU x 1000mm:	D81SP*
48 RU x 1200mm:	D82SP*
Vertical Blanking Panels	
600mm:	D6VBP*
800mm:	D8VBP*
Bottom Cover Plates	
600mm wide x 1000mm depth:	D61BCP*
600mm wide x 1200mm depth:	D62BCP*
800mm wide x 1000mm depth:	D81BCP*
800mm wide x 1200mm depth:	D82BCP*
Tapped Equipment Rails	
42 RU:	D2ERT*
45 RU:	D5ERT*
48 RU:	D8ERT*
Cage Nut Equipment Rails	
42 RU:	D2ER*
45 RU:	D5ER*
48 RU:	D8ER*
PDU/Cable Management Bracket	
42 RU:	D2CM*
45 RU:	D5CM*
48 RU:	D8CM*
Accessories Cable Management Fingers with Mounting Brackets for 800mm Wide Cabinet	
42 RU:	D12FB*
45 RU:	D15FB*
48 RU:	D18FB*

*Available in Black (B) or White (W)

Net-Verse™ Cabinets

Net-Verse™ Cabinet 600mm W x 42/45/48 RU x 1000mm/1200mm D

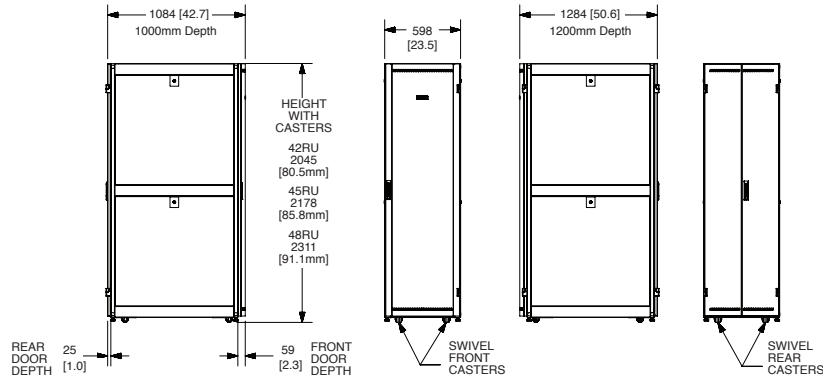
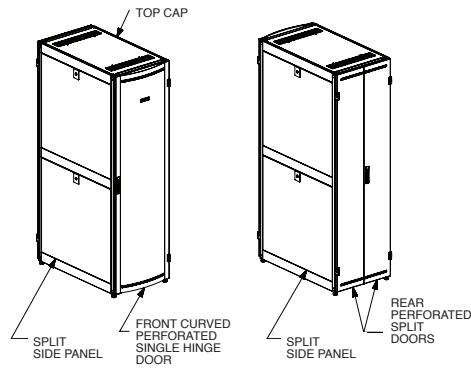

Net-Verse™ Cabinet 800mm W x 42/45/48 RU x 1000mm/1200mm D

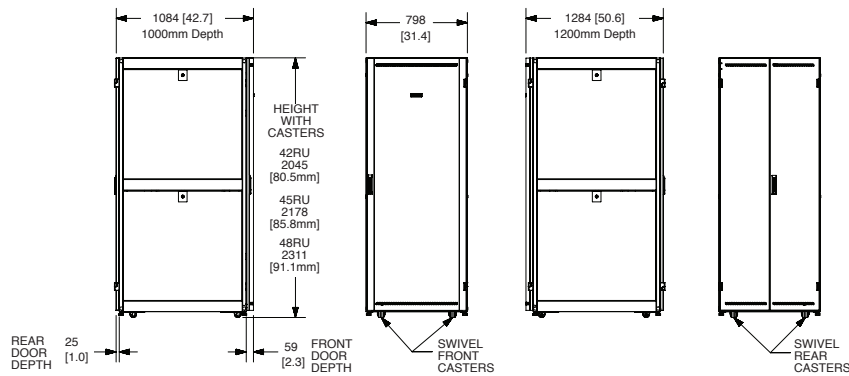
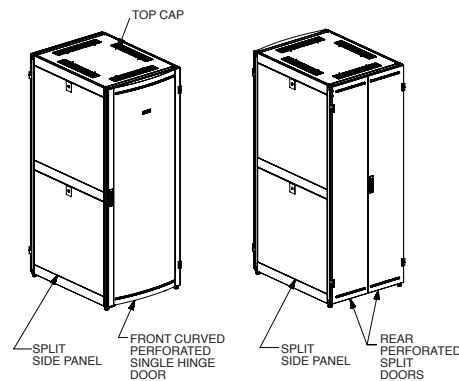

Dimensions are in metric. [Dimensions in brackets are inches].

WORLDWIDE SUBSIDIARIES AND SALES OFFICES

PANDUIT US/CANADA
Phone: 800.777.3300

PANDUIT EUROPE LTD.
London, UK
Phone: 44.20.8601.7200

PANDUIT SINGAPORE PTE. LTD.
Republic of Singapore
Phone: 65.6305.7575

PANDUIT JAPAN
Tokyo, Japan
Phone: 81.3.6863.6000

PANDUIT LATIN AMERICA
Guadalajara, Mexico
Phone: 52.33.3777.6000

PANDUIT AUSTRALIA PTY. LTD.
Victoria, Australia
Phone: 61.3.9794.9020

For a copy of Panduit product warranties, log on to www.panduit.com/warranty

PANDUIT®

For more information
Visit us at www.panduit.com

©2019 Panduit Corp.
ALL RIGHTS RESERVED.
RKSP183--WW-ENG
6/2019