

RIGID PVC CONDUIT  
CONDUIT RIGIDE EN PVC

HWY BOX FLG W/C / BTE JCT RENFORCEE

ISSUE DATE: 2013 12 13  
DATE D'EMISSION:

SUPERSEDES: 2003 07 31  
REPLACE:

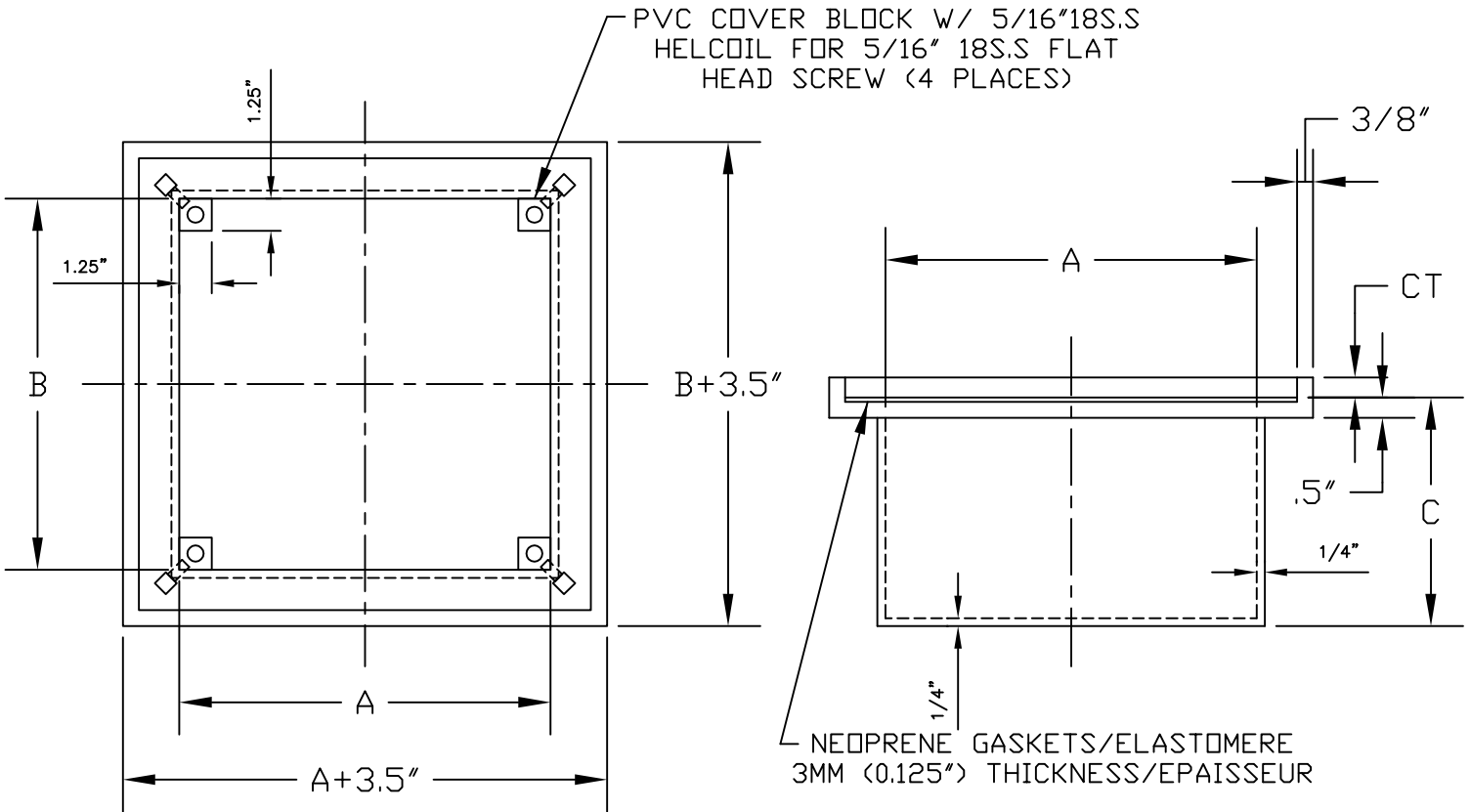

CODE	Size Grosueur	A Ref.	B Ref.	C Ref.	D Ref.	CT Ref.
076132 076662 077685	150mmx150mmx100mm (6"x6"x4")	152mm (6.0")	152mm (6.0")	108mm (4.25")	22mm (0.875")	6mm (0.25")
076663 076966 077686	150mmx150mmx150mm (6"x6"x6")	152mm (6.0")	152mm (6.0")	159mm (6.25")	22mm (0.875")	6mm (0.25")
076125 076664 077687	200mmx200mmx100mm (8"x8"x4")	203mm (8.0")	203mm (8.0")	108mm (4.25")	22mm (0.875")	10mm (0.375")
077688	200mmx200mmx150mm (8"x8"x6")	203mm (8.0")	203mm (8.0")	108mm (6.25")	22mm (0.875")	10mm (0.375")
076665 077689 077692 076133	200mmx200mmx175mm (8"x8"x7")	203mm (8.0")	203mm (8.0")	108mm (7.25")	22mm (0.875")	10mm (0.375")