

ACS880-07 Product Overview

Description

Cabinet-built single drives, ACS880-07

Our cabinet-built single drives are built to order, meeting customer needs despite any technical challenges. Designed on ABB's common drives architecture, this compact drive comes in four different sizes (R6 to R9) for easy installation and commissioning.

These single drives are customized to the precise needs of industries such as oil and gas, mining, metals, chemicals, cement, power plants, material handling, pulp and paper, woodworking and marine. Typical applications include cranes, extruders, winches, conveyors, mixers, compressors, pumps and fans. The drive configuration contains a rectifier, DC link and an inverter, all built into a compact cabinet.

At the heart of the drive is direct torque control (DTC), ABB's premier motor control technology. The drive can control the motors in either open loop or closed loop. Induction motors, synchronous motors and induction servo motors are all supported as standard without the need for additional software.

Drive Module Main features include

- Incoming air temperature measurement for protecting the drive from different temperature related failure mechanisms
- Integrated safety including safe torque-off (STO) as standard (TÜV Nord certificate)
- Supports various motor types including: Asynchronous induction and synchronous PM motors,
- Removable memory unit for easy maintenance
- Primary control program - common software used throughout the ACS880 drive series
- Control unit supporting a wide range of fieldbuses, feedback devices and input/output options
- Coated boards as standard
- Controllable cooling fan
- Built-in DC choke

Standard Main Cabinet features include (with +C129 UL Option)

- Compact design for easy cabinet assembly and maintenance
- Intuitive and easy to operate control panel with USB connection
- Cabling : top entry and exit cabling
- Enclosure class UL Type1 (IP22)
- Solid removable 3mm cable conduit plate
- Disconnect Switch with rotary through the door handle
- Fast acting UL fuses



Applications:

- Constant Torque, Variable Torque or Constant Horsepower applications.
- New installation, replacement and original equipment manufacturer (OEM) use.

Features:

- DTC or Scalar (V/Hz) control with peak overload of 150% for performance applications. Flexible enclosure drive options, built to order with 2 enclosure classes. ABB's all compatible keypad, programming structure and drive options. Designed for demanding applications with: high starting torque, speed and torque accuracy, flexible programming and certified safety options.

ACS880 Standard Features

Standard Features

- UL and cUL (07 requires +C129 option selection)
- Graphical Multilingual Display
- Graphical metering and trending on display
- Intelligent Start-Up Assistant
- Motor ID Run
- Motor Control
- Direct Torque Control (DTC)
 - Scalar Control
- Input Fuses and Disconnect (07)
- Two (2) programmable Analog Inputs
- Six (6) Programmable Digital inputs
- Two (2) Programmable Digital Inputs/Outputs
- One (1) Digital Input InterLock (DILL)
- Two (2) programmable Analog Outputs
- Three (3) Programmable Form C Relay Outputs
- Dual input Safe Torque Off (STO)
- Three (3) expansion slots for Fieldbus, communications, I/O and Motor feedback expansion modules
- Adjustable filters on Analog inputs and outputs
- Input Speed Signals
 - Two (2) Voltage +/- 0 (2)- 10VDC / Current 0 (4) - 20 mA (Selectable via jumper)
 - Increase/Decrease reference Contacts
 - FieldBus adapters (communication modules)
- Start/Stop
 - 2 wire control (dry contact closure)
 - 3 wire control (momentary dry contacts)
- Adjustable Current Limit
- Adjustable Torque Limit
- Three (3) Supervision Functions
- Electronic Reverse
- Power Loss Ride- Through
- DC Magnetizing Start (provides max starting torque)
- DC Hold
- Flux Braking
- Energy (flux) Optimization
- Seven (7) Preset Constant Speeds
- Three (3) Critical Speed Lockout Bands
- Automatic Reset Customer Selectable
- Two (2) Independently Adjustable Accel and Decel Ramps
- Linear or Adjustable "S" Curve Accel/Decel Ramps
- Ramp to Stop or Coast to a Stop
- Maximum Output Frequency Programmable up to 500 Hz
- Two (2) Integral Programmable PID Setpoint Controller
- Mathematical Functions on Analog Reference Signals
- Reactor with ~3% impedance - DC (R1 through R9 Frame)
- Integral Brake Chopper (R1 Through R4 Frames)
- Optional Integral Brake Chopper (R4 through R9)
- Reference Trim
- Programmable Mechanical Brake Control
- Master/Follower
- Load Analyzer
- Two (2) Jogging functions

Programmable Fault Functions

- AI<Min
- Panel Loss
- Four (4) External Fault
- Motor Thermal Protection
- Motor Stall
- Under load
- Motor Phase Loss
- Ground Fault
- Communications Fault
- Supervision of optional I/O
- Cross Connection (Input/Output Power Wiring)
- External measure temperature
- Preprogrammed Protections:
 - Over current
 - Short Circuit
 - Over voltage (Intermediate Circuit)
 - Under voltage (Intermediate Circuit)
 - Input Phase Loss
 - Ambient temperature
 - Drive over temperature
 - Internal fault
 - Over Speed
 - Brake Resistor

Available options

- I/O Options
 - DDCS Communications Card FDCO-01/02
 - Analog I/O Extension Card FIO-11
 - Digital I/O Extension Card FIO-01
 - HTL Pulse Encoder Interface FEN-31
 - TTL Pulse Encoder Interface FEN-01
 - Resolver Interface FEN-21
 - Absolute Encoder Interface FEN-11
- Fieldbus Adapter Modules
 - DeviceNet™
 - Profibus-DP™
 - ModBus™ Adapter
 - Ethernet (EIP,PROFINET,MB/TCP)
 - CANOpen
- Dynamic Braking Choppers (R5 Frame and Up)
- CE EMC Filters (1st and 2nd Environments)
- Drive Composer PC Tool (available for download)
- Drive Composer Pro PC Tool

Application Software options

- Primary Control Program

ACS880 Specifications

Input Connection

Input Voltage	380-500Vac 3-phase +10%...-15% (-01) +/-10% (-07)
Input Frequency.....	47 to 63 Hz, maximum rate of change 17%/s
Line Imbalance	Max +/-3% of nominal phase to phase input voltage
Fundamental Power Factor (cos j)	0.98 (at nominal load)
Connection	Terminals U1, V1, W1

Output Connection

Output Voltage.....	0 to U1, 3-phase symmetrical, Umax at the field weakening Point
Output Frequency.....	0 ..500Hz
Continuous Current.....	1.0 * I2Ld (light duty use)
.....	1.0* I2hd (heavy-duty use)
Short Term Overload Capacity.....	I2Ldmax = 1.1 * I2Ld (1 min / 5 minutes @ 40°C), typical Ihdmax = 1.5 * I2hd (at least 1 min / 5 min @ 40°C)
Peak Overload Capacity	I _{max} (400 Vac and 500 Vac) (at least 10 seconds at start)
Field Weakening Point.....	8 to 500 Hz
Switching Frequency	2.7 kHz (average), DTC dynamically varies from 1 to 12kHz
Efficiency	98% at nominal power level
Short circuit withstand rating	100,000 AIC (UL) R1-R9 when protected by fuses given in the hardware manual
Connection	U2, V2, W2

Ambient Conditions, Operation

Air Temperature.....	0° to 40°C (104°F), above 40°C the maximum output Current is de-rated 1% for every additional 1°C (up to 50°C) (122°F) for -07 drives
Relative Humidity.....	5 to 95%, no condensation allowed, maximum relative humidity is 60% in the presence of corrosive gasses
Contamination Levels	
IEC	60721-3-1, 60721-3-2 and 60721-3-3
Chemical Gasses	Class 3C2
Solid Particles.....	Class 3S2
Installation Site Altitude	0 to 1000m (3281ft) above sea level. At sites over 1000m (3281ft) above sea level, the maximum power is de-rated 1% for every additional 100m (330ft). Maximum altitude 4000m (13123 ft) above sea level.
Vibration Max	1mm (0.04") 5 to 13.2 Hz, Max 7 m/s ² (23 ft/s ²) 13.2 to 100 Hz Sinusoidal

Ambient Conditions, Storage & Transportation (in Protective Shipping Package)

Air Temperature.....	-40° to 70°C (-40° to 158°F)
Relative Humidity.....	5 to 95%, no condensation allowed
Atmospheric Pressure	70 to 106 kPa (10.2 to 15.4 PSI)
Vibration Max	1mm (0.04") 5 to 13.2 Hz, Max 7 m/s ² (23 ft/s ²) 13.2 to 100 Hz
Shock (IEC 60068-2-29)	Max 100 m/s ² (330 ft/s ²) 11 ms
Free Fall	100mm (4 in.) for weight greater than 100Kg (220lbs)

Cooling Information

Cooling Method	Internal Fan
Power Loss.....	Approximately 2% of rated power

Auxiliary Power Supply (XD 24:2 and XD 24:4)

Voltage.....	24 Vdc, +/- 10%
Maximum Current	200 mA – minus load taken by DIO1 and DIO2
Protection	Short Circuit Protection

Control Terminal Blocks	Size 0.5 ... 2.5 mm ² (24...12 AWG) - All control terminal blocks
.....	Tightening torques: 0.5 N•m (5 lbf•in) for both stranded and solid wiring

Analog Inputs

Two (2) Programmable Differential Inputs	
Two (2) Current or Voltage Signals	0 (4) to 20 mA, Input Resistance R _I => 100 ohms or -10Vdc / 0(2) to +10Vdc, Input Resistance R _I =>200 k-ohms
Common Mode Voltage	+/-15 Vdc, max.
Common Mode Rejection Ratio	> 60 dB at 50 Hz
Resolution	0.025% (12 bit) (11 bit + Sign bit)
Accuracy.....	+/-0.5% of Full Scale Range
Input Updating Time	1 ms (Primary Control Program)
Optional Isolation.....	Available through optional external module

ACS880 Specifications (cont.)

Reference Power Supply

Voltage.....	+10Vdc, 0, -10Vdc +/- 0.5% at 25° C (77° F)
Maximum Load.....	10 mA
Applicable Potentiometer.....	1 k-ohm to 10 k-ohm

Analog Outputs

Two (2) Programmable Current Outputs	
Signal Level.....	0 (4) to 20 mA
Resolution.....	0.025% (12 bit) (11bit +Sign Bit)
Accuracy.....	+/-1% Full Scale Range
Maximum Load Impedance.....	500 ohms
Output Updating Time.....	1 ms (Primary Control Program)
Frequency Range.....	0 ... 300Hz

Digital Inputs

Six (6) Programmable Digital Inputs (Common Ground), plus One (1) Start Interlock	
Isolation.....	Isolated
Isolation Test Voltage.....	500 VAC, 1 minute
Input Type.....	NPN/PNP (DI1...DI5), NPN (DI6)
Signal Level.....	24Vdc
Rin.....	2.0 kohm
Logical switch thresholds.....	< 5Vdc at "0", >15Vdc at "1"
Input Current.....	15 mA, Digital Input 1 to Digital Input 5, 5 mA Digital Input 6
Filtering Time Constant.....	Hardware Filter .04 ms
Input Updating Time.....	Digital Filtering up to 8 ms (Primary Control Program)
Frequency Range.....	0 ... 300Hz

Digital Inputs/Output

Two (2) Programmable Digital Inputs/Outputs	
Isolation.....	Isolated
Input Configuration.....	DIO1 frequency input (0 ... 16KHz with 4 microsecond hardware filtering)
Output Configuration.....	DIO2 frequency output (0 ... 16KHz with 4 microsecond hardware filtering)
Signal Level.....	24Vdc
Rin.....	2.0 kohm
Logical input switch thresholds.....	< 5Vdc at "0", >15Vdc at "1"
Filtering Time Constant.....	0.25 ms
As output.....	Total output current from +24VD is limited to 200 ma

Safe Torque Off Connection

Input Voltage Range.....	-3 ... 30 V DC
Logical input switch thresholds.....	< 5Vdc at "0", >17Vdc at "1"
.....	Both input connection must be closed for the drive to start
Current Consumption.....	55 mA (continuous)
EMC Immunity.....	according to IEC 61326-3-1

Internal 24 Vdc Supply for Digital Inputs

Voltage.....	24Vdc
Maximum Current.....	200 mA
Connector.....	XD24:2 and XD24:4
Protection.....	Short Circuit Proof
An external 24 Vdc supply may be used instead of the internal supply	

Relay Outputs

Three (3) Programmable Relay Outputs	
Switching Capacity.....	2 A at 30Vdc or 250Vac
Protection.....	Varistors (250 V)
Maximum Continuous Current.....	IC = 2 Amps RMS
Output Updating Time.....	1 ms (Primary Control Program)

Protections

Single Phase.....	Protected (input & output)
Over Voltage Trip Limit.....	1.3 * U1max
Under Voltage Trip Limit.....	0.65 * U1min
Over Temperature.....	Protected
Auxiliary Voltage.....	Short Circuit Protected
Ground Fault.....	Protected
Motor Stall Protection.....	Protected
Motor Over Temperature.....	Protected (I2t)
Cross Cable Connection.....	Protected

ACS880 control Panel

The ACS880 assistant control panel features a graphical display for easy drive configuration. The LCD type display has a monochrome 240 x 160 pixel resolution with a white backlight. The language is selected at start-up (parameter 96.01). It is an ideal tool for users and service technicians that provides the following features:

- Large Graphical Display
- Easy navigation
- Familiar set of keys, including
 - Up, down, left, and right arrows
 - Start and Stop Keys
 - Two soft keys
 - Help key
 - Local/ Remote
- Graphical monitoring
- Parameter back up
- Real time clock
- USB Connector for PC connection

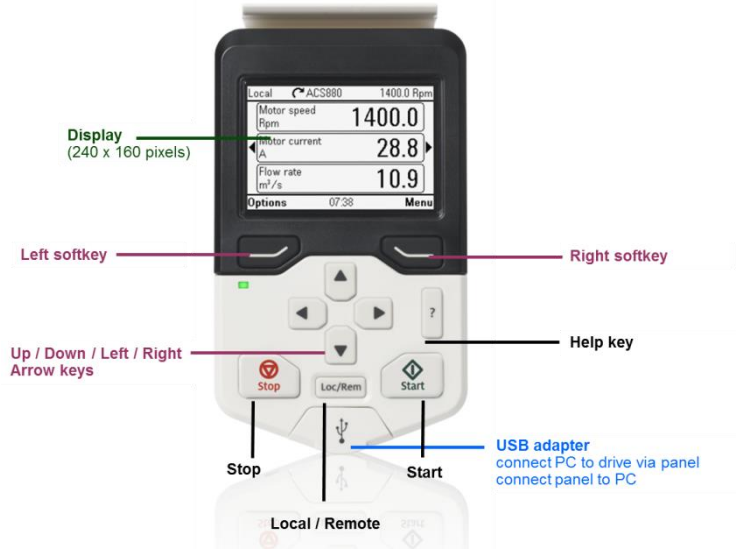

Ease of Navigation and Start Up

The control panel is intuitive to use and includes multiple home views with graphical displays for quick visual feedback of the motor and drive status. The soft keys allow for easy navigation through the drive's menu system.

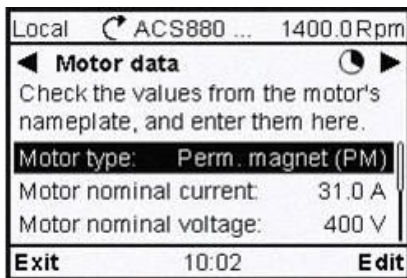

The ACS880 control panel features a set-up assistant that prompts the user through the commissioning process. It navigates through the parameters that pertain to initial set up and allows easy entry of motor and line settings. It then allows the selection of different ID run procedures, including normal rotation, reduced rotation, and without rotation, and to customize selections based on the existing conditions.

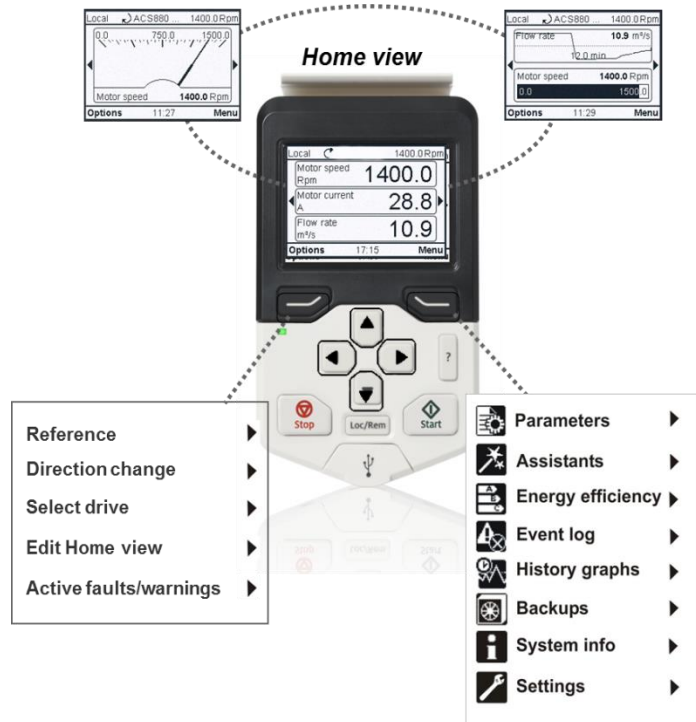

Cable Connections

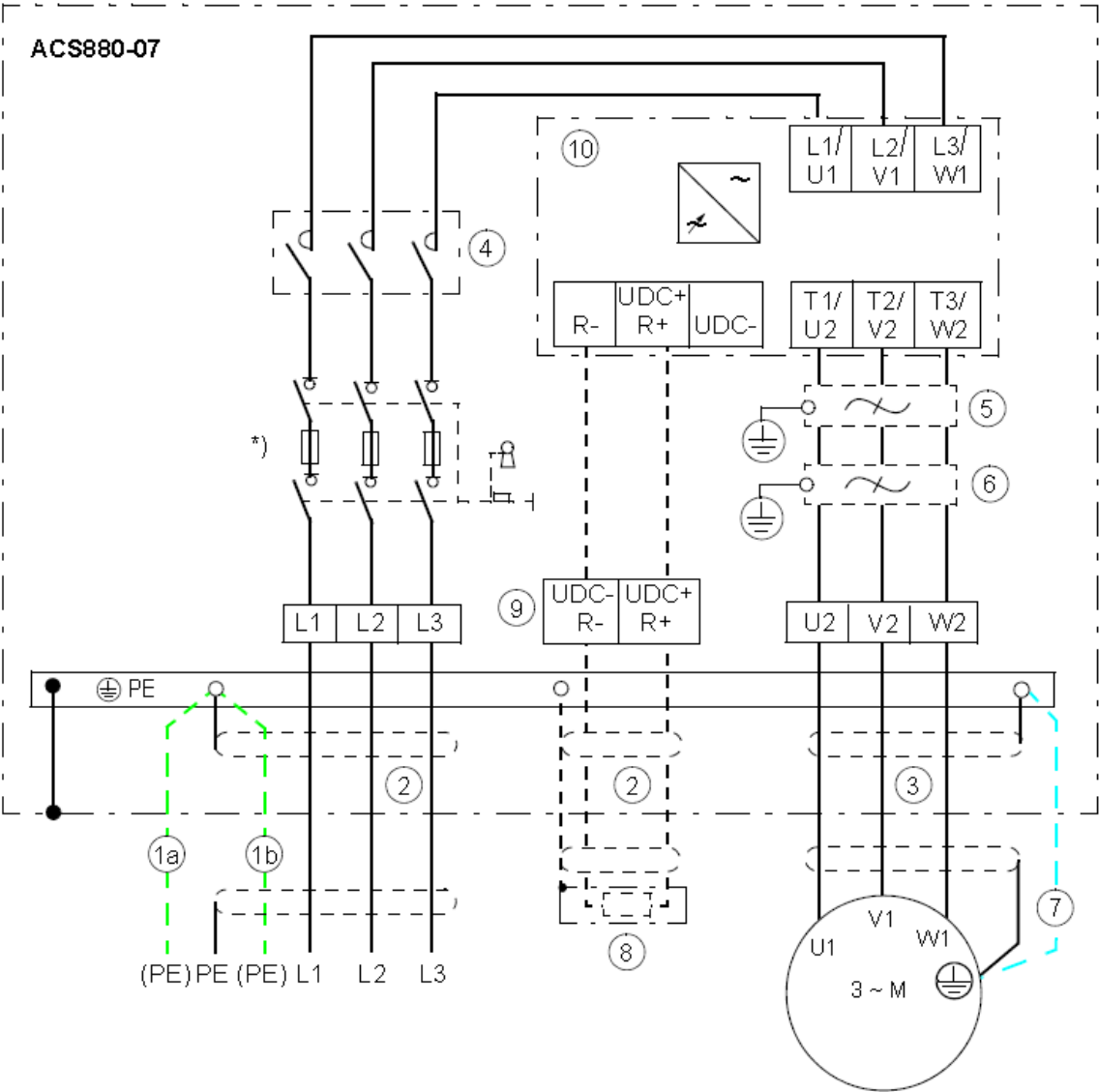

1. Use a separate grounding PE cable (1a) or a cable with a separate PE conductor, follow local codes for cable size
2. 360-degree grounding is recommended if shielded cable is used. Ground the other end of the input cable shield or PE conductor at the distribution board.
3. 360-degree grounding is required using shielded cable or conduit.
4. Line contactor (option +F250)
5. Common mode filter (option +E208)
6. du/dt filter or sine filter (options +E205 and +E206)
7. Use a separate grounding cable if there is no symmetrically constructed grounding conductor in the cable.
8. External brake resistor
9. Terminals of frame R9 cabinet:

R-	UDC+	
	R+	UDC-
10. Drive module

Frame size	Terminals L1, L2, L3, U2, V2, W2, UDC+/R+, UDC- and R-			Grounding terminals	
	Max. phase conductor size AWG/kcmil	Busbar bolt size – Hole spacing	Tightening torque	Bolt size	Tightening torque N-m
R6	350 MCM	M10 (3/8") × 2 – 1.75"	15... 30 lbf-ft	M10 (3/8")	22... 32 lbf-ft
R7					
R8	1×500 MCM or 2×350 MCM	M12 (7/16") × 2 – 1.75"	37... 55 lbf-ft		
R9	2×500 MCM				

Input and motor cable terminal dimensions of frames R6 to R7

Bottom entry and exit:

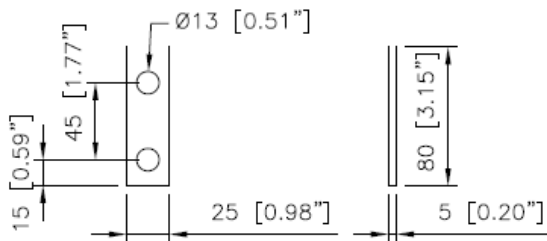

Top entry and exit:

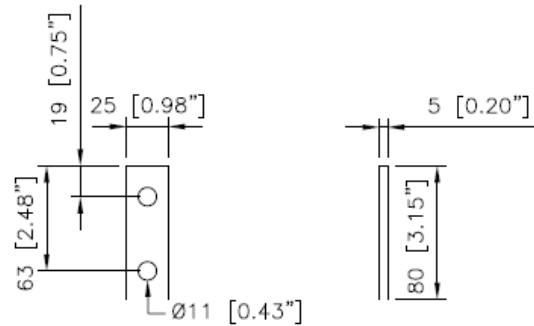

Input and motor cable terminal dimensions of frame R8

Bottom entry and exit:

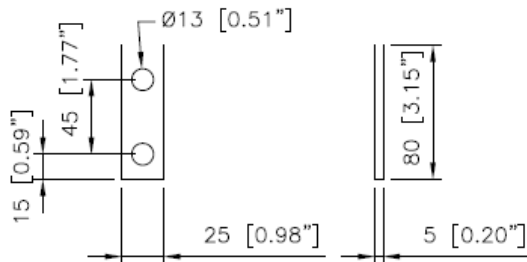

Top entry and exit:

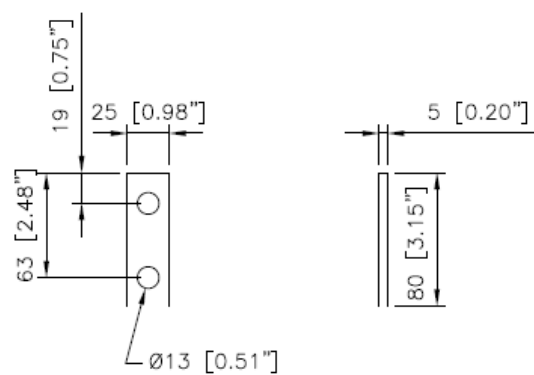

Resistor and DC cable terminal dimensions of frames R6 to R8

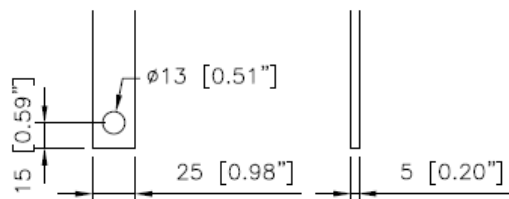

Motor cable terminal dimensions of frame R9 – Units with optional du/dt filter (+E205):

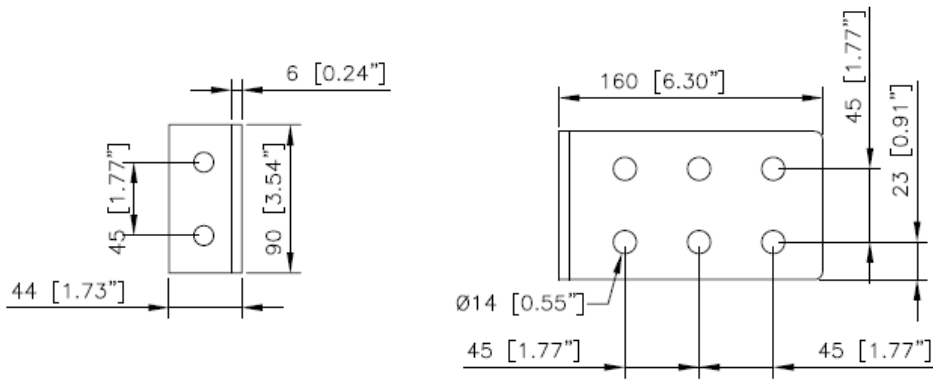

Motor cable terminal dimensions of frame R9 – Units without optional du/dt filter (+E205):

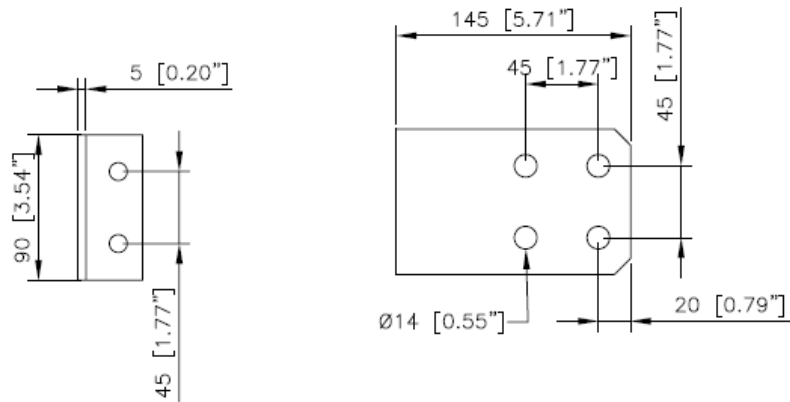

Default I/O connection diagram (Factory Macro) of frames R6 to R9

Typical External Devices
Not Included

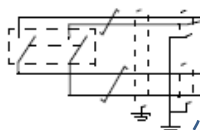
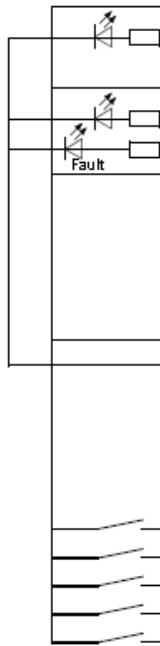
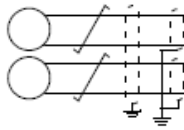
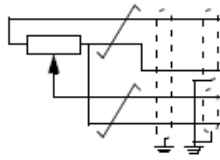

XPOW External power input

1	+24VI	24 V DC, 2 A
2	GND	

XAI Reference voltage and analog inputs

1	+VREF	10 V DC, R_L 1... 10 kohm
2	-VREF	-10 V DC, R_L 1... 10 kohm
3	AGND	Ground
4	AI1+	Speed reference 0(2)... 10 V, $R_{in} > 200$ kohm ¹⁾
5	AI1-	
6	AI2+	By default not in use. 0(4)... 20 mA, $R_{in} > 100$ ohm ²⁾
7	AI2-	
J1	J1	AI1 current/voltage selection jumper
J2	J2	AI2 current/voltage selection jumper

XAO Analog outputs

1	AO1	Motor speed rpm 0... 20 mA, $R_L < 500$ ohm
2	AGND	
3	AO2	Motor current 0... 20 mA, $R_L < 500$ ohm
4	AGND	

XD2D Drive-to-drive link

1	B	Drive-to-drive link
2	A	
3	BGND	
J3	J3	Drive-to-drive link termination switch

XRO1, XRO2, XRO3 Relay outputs

1	NC	Ready 250 V AC / 30 V DC 2 A
2	COM	
3	NO	
1	NC	Running 250 V AC / 30 V DC 2 A
2	COM	
3	NO	
1	NC	Faulted(-1) 250 V AC / 30 V DC 2 A
2	COM	
3	NO	

XD24 Digital interlock

1	DIIL	Digital start interlock
2	+24VD	+24 V DC 200 mA ³⁾
3	DICOM	Digital input ground
4	+24VD	+24 V DC 200 mA ³⁾
5	DIOGN	Digital input/output ground
J6	J6	Ground selection switch

XDIO Digital input/outputs

1	DIO1	Output: Ready
2	DIO2	Output: Running

XDI Digital inputs

1	DI1	Stop (0) / Start (1)
2	DI2	Forward (0) / Reverse (1)
3	DI3	Reset
4	DI4	Acceleration & deceleration select ⁴⁾
5	DI5	Constant speed 1 (1 = On) ⁵⁾
6	DI6	By default not in use.

XSTO Safe torque off

1	OUT1	Safe torque off. Both circuits must be closed for the drive to start.
2	SGND	
3	IN1	
4	IN2	

X12 Safety functions module connection

X13 Control panel connection

X205 Memory unit connection

Control unit terminal wire sizes: 0.5 ... 2.5 mm² (24...12 AWG). Tightening torques: 0.5 N·m (5 lbf·in) for both stranded and solid wiring