

# A-2

## Unilet® Conduit Outlet Bodies: FM7™, FM8®, Form 35® and Form 85™

For use with Rigid Steel, Rigid Aluminum, IMC, and EMT Conduit.

### Applications

- Serve as pulling fittings.
- Make bends in conduit system.
- Provide openings for splicing.
- Connect and change direction of conduit runs.
- Allow connections for branch runs.
- Permit access to conductors for maintenance.

### Features: Unilet® conduit outlet bodies

- Roomy interiors: more wiring space.
- Smooth, rounded integral bushings in hubs protect conductor insulation.
- Accurately tapped, tapered threads for tight, rigid joints and excellent ground continuity.

### Features: FM7™ Series

- ① FM7 Grayloy™-Iron Unilets: most economical conduit bodies for use where the special advantages of malleable iron or aluminum are not required.
- ② FM7 Aluminum Unilets: same dimensions and design features as FM7 Grayloy™-Iron, plus light weight, high corrosion resistance.
- FM7 Wedge-Lok™ Formtite™ covers with integral gasket are approved for use in wet locations.
- Unique Wedge-Lok™ clip covers allow easy removal. No retapping of corroded body screw holes is necessary to replace cover.
- Completely interchangeable with Crouse-Hinds Form 7™ bodies, gaskets and covers. Equivalent FM7 and Form 7™ units have identical applications and installation dimensions.
- Flat back design provides greater cubic content for easier wire pulling and more room for splicing.
- Smooth hub bushings and cover openings protect conductor insulation. Smooth hub openings allow easy conduit joining.



FM7



① FM7 Grayloy™-iron, 1" Type C shown with cut-away body and clip to illustrate Wedge-Lok™ Clip Cover detail.



② FM7 Aluminum Conduit Body with Cast Aluminum Cover. 1" Type C shown.



③ FM8 Grayloy™-iron Conduit Body with cast cover. 1" Type C shown.



④ Form 35 Malleable. 2" Type LB with rollers shown.



⑤ Form 85 Aluminum Conduit Body with Stamped Aluminum Cover. 2" Type C shown.

- Pan-head cover screws secure cover clips and provide superior screwdriver seating and torque. Cover screws and clips are captive to prevent loss.
- Hub size, body style, and compliance data molded into body in large, easy-to-read form. Also maximum wire number/size and cubic capacity.

### Features: FM8® Series

- ⑥ Completely interchangeable with Crouse-Hinds Form 8™ bodies, gaskets and covers. Equivalent FM8 and Form 8\* units have identical applications and installation dimensions.
- Flat back design provides greater cubic content for easier wire pulling and more room for splicing.

- FM8 Grayloy™-iron with "FG" Series cast covers and gaskets are approved for use in wet locations.
- Stainless steel screws on stamped and cast covers.
- Smooth hub bushings and cover openings protect conductor insulation. Smooth hub openings allow easy conduit joining.

\*Form 7 and Form 8 are products of Crouse-Hinds, a member company of Cooper Industries.



FM8

## Unilet® Conduit Outlet Bodies: FM7™, FM8®, Form 35® and Form 85™

For use with Rigid Steel, Rigid Aluminum, IMC, and EMT Conduit.

### Features: Form 35®

- Form 35 malleable iron Unilets: high tensile strength and ductility. High corrosion-resistance, high impact and shock resistance.
- Exclusive built-in easy-pulling rollers in type C (1-1/4" thru 4") and type LB (1-1/4" thru 4")— eliminate damage when cable is pulled through hubs.
- Sizes with flat-back design ideal where fitting is mounted flat against surface.
- Complete line of conduit bodies, covers and receptacles.
- Blank covers domed for extra wiring space.



Form 35



Form 35

### Features: Form 85™

- Form 85 aluminum Unilets: copper-free aluminum (max. 4/10 of 1% copper content). Lightweight, high corrosion resistance. Self-oxidizing, self-renewing.
- Lightweight aluminum facilitates shipping, handling and installing.
- Sizes with flat-back design ideal where fitting is mounted flat against surface.
- Complete line of conduit bodies, covers and receptacles.
- Blank covers domed for extra wiring space.



Form 85

### Standard Materials

- *Form 35 Unilet conduit outlet bodies:* malleable iron.
- *Form 85 Unilet conduit outlet bodies:* aluminum— copper-free (max. 4/10 of 1%). 1/2" thru 2"— pressure cast. 2-1/2" thru 4"— sand cast.
- *FM7 Unilet conduit bodies:* Grayloy-iron or copper-free aluminum.
- *FM8 Unilet conduit bodies:* Grayloy-iron.
- *Covers for Form 35 and 85:* blank—malleable iron, steel and aluminum. Duplex grounding receptacle— phenolic. Lamp receptacle— porcelain. Wiring device and switch covers— aluminum. Cover screws: stainless steel.
- *Covers for FM7:* stamped steel, stamped aluminum, cast Grayloy-iron, and cast aluminum; cover screws: stainless steel.
- *Covers for FM8:* cast Grayloy-iron, stamped steel; cover screws: stainless steel.
- *Gaskets for Form 35 and Form 85:* neoprene or composition fiber.
- *Gaskets for FM7 and FM8:* neoprene.

### Standard Finishes

- *Form 35 malleable iron bodies:* triple-coat— (1) zinc electroplate, (2) dichromate, and (3) epoxy powder coat.
- *Form 35 Covers:* steel: zinc electroplate. Malleable iron: triple-coat— (1) zinc electroplate, (2) dichromate, and (3) epoxy powder coat.
- *Form 85 aluminum bodies:* epoxy powder coat.
- *Form 85 stamped aluminum covers:* natural finish.
- *Form 85 cast aluminum covers:* epoxy powder coat.
- *FM7 and FM8 Grayloy-iron bodies:* triple-coat— (1) zinc electroplate, (2) dichromate, and (3) epoxy powder coat.

- *FM7 aluminum bodies:* epoxy powder coat.
- *FM7 and FM8 steel covers:* zinc electroplate.
- *FM7 stamped aluminum covers:* natural finish.
- *FM7 and FM8 Grayloy-iron covers:* triple-coat— (1) zinc electroplate, (2) dichromate, and (3) epoxy powder coat.
- *FM7 cast aluminum covers:* epoxy powder coat.

### Compliances

- UL Standard 514A.
- Federal Spec. W-C-586B.
- Suitable for classified location use in Class I, Division 2 areas, if installed in compliance with NEC 501-4(b).
- Appleton malleable iron products conform to ASTM A47-77, Grade 32510, which has the following properties: tensile strength, 50,000 psi; yield, 32,000 psi; and elongation, 10%.
- Appleton aluminum products are produced from a high strength copper-free (4/10 of 1% max.) alloy.
- Appleton Grayloy-iron products are a gray iron alloy with tensile strength similar to ASTM-A48 Class 30A (30,000 psi tensile), and with a Brinell hardness of approximately 180BH.

### Product Cross Reference

- For explosionproof conduit outlet bodies and boxes, see Cat. Section J.
- For Mogul Unilets®, see pages A-17 through A-24.

## FM7™ Grayloy™ –Iron and Aluminum Unilet® Conduit Bodies: Wedge-Lok™ Clip Covers; FM8® Grayloy™ –Iron Conduit Bodies and Covers

For use with Rigid Steel, Rigid Aluminum and IMC Conduit.

**Freedom of Choice.** With new FM8 series added to Appleton's full-line family of conduit bodies, you have a single source for the right choice needed for every job— FM8 Grayloy-iron bodies and covers, FM7 Grayloy-iron or aluminum threaded bodies and covers... malleable iron Form 35... aluminum Form 85... and malleable iron or aluminum NEC Mogul 6x8x.

**Interchangeable.** Appleton FM7 and FM8 bodies, covers and gaskets are completely interchangeable with equivalent Crouse-Hinds Form 7\* and Form 8\* bodies and covers. Applications and installation dimensions are also interchangeable.

**No wire damage.** Appleton FM7 and FM8 bodies have a smooth, rounded, internal bushing in each hub and smooth cover openings to protect conductor insulation.

**Easy cover removal.** Unique FM7 Wedge-Lok Clip-Cover design allows easy removal at any later time, without damaging the conduit body. Because the cover is secured with clips— not screws — no retapping of corroded body screw holes is necessary to replace cover.

**Positive-seating cover screws.** Pan-head stainless steel cover screws, which hold the clips, provide superior screw-driver seating and torque for easier cover installation or removal. Each cover screw and its attached locking clip are held captive in the cover to prevent loss.

**Full-line choice.** Appleton FM7 and FM8 bodies are offered in a complete range of hub configurations and sizes. FM7 covers are available in blank stamped steel or stamped aluminum, and also in cast Grayloy-iron or cast aluminum. FM8 covers are available in Grayloy-iron. Covers can be

used without gaskets, or with a solid neoprene gasket. All Appleton FM7 and FM8 bodies, covers and gaskets are interchangeable with Crouse-Hinds Form 7\* and Form 8\* bodies, covers and gaskets.

**Approved for wet locations.** FM7 and FM8 Grayloy-iron bodies with the "FG" series cast covers and gasket are approved for use in wet locations. (NEMA 3R)

**Maximum corrosion protection.** Appleton FM7 and FM8 Grayloy-iron conduit bodies and cast covers have a triple-coat finish— (1) zinc electroplate, (2) dichromate, and (3) epoxy powder coating. FM7 aluminum bodies and cast covers are coated with epoxy powder coating. FM7 and FM8 blank steel covers have a zinc electroplate finish. Superior FM7 and FM8 finish gives greater corrosion protection in wet or harsh environments, assuring long, trouble-free service.

**Grayloy-iron properties.** Grayloy™ is an Appleton proprietary cast graphite flake gray iron alloy with superior physical and mechanical properties offering strength, hardness, fracture toughness, high vibration absorption and dimensional stability. Tensile strength is similar to ASTM-A48 Class 30A (30,000 tensile), with Brinell hardness of approximately 180BH.

**Aluminum properties.** Aluminum products are produced from a high strength copper-free (4/10 of 1% max.) alloy.

**More wiring space.** Appleton's FM7 and FM8 flat-back design provides greater cubic content for easier wire pulling, and more room for splicing. FM7 and FM8 flat back fits flush and snug against flat surfaces for more stable installation.

\* Form 7 and Form 8 are products of Crouse-Hinds, a member company of Cooper Industries.



Neoprene Integral Gasket pre-assembled to Conduit Body Cover

- One-piece cover and gasket assembly
- Neoprene gasket is bonded to Iron, Steel or Aluminum cover
- Ease of installation
- Productivity gain
- Eliminates "stock outs" of one item or the other
- No need to order, store, handle, or install separate covers and gaskets because there are fewer SKU's to order and inventory



Appleton FM7 (C57, 1-1/2")  
28 Cubic Inches Capacity  
Flat-Back Design



Crouse-Hinds Form 7 (C57, 1-1/2")  
26 Cubic Inches Capacity

**Appleton FM7:**

- Maximum wire number/size and cubic capacity molded into body.
- Large size, style and compliance data molded into body.





Illustrated views are cut away to demonstrate back configurations.

## FM7™ Grayloy™ - Iron and Aluminum Unilet® Conduit Bodies with Wedge-Lok™ Clip Covers and Gaskets





For use with Rigid Steel, Rigid Aluminum and IMC Conduit.

These Appleton FM7 conduit bodies, covers and gaskets have the same applications and installation dimensions as Crouse-Hinds Form 7 conduit bodies. Equivalent FM7 and Form 7 items are completely interchangeable.

### Appleton FM7 Conduit Bodies NOTE: Refer to page A-15 for Wiring Capacity Tables





Hub Size (in.)	<b>C</b> 		<b>LB</b> 		<b>LL</b> 		<b>LR</b> 		<b>T</b> 	
	Grayloy-Iron	Aluminum	Grayloy-Iron	Aluminum	Grayloy-Iron	Aluminum	Grayloy-Iron	Aluminum	Grayloy-Iron	Aluminum
1/2	C17	C17-SA	LB17	LB17-SA	LL17	LL17-SA	LR17	LR17-SA	T17	T17-SA
3/4	C27	C27-SA	LB27	LB27-SA	LL27	LL27-SA	LR27	LR27-SA	T27	T27-SA
1	C37	C37-SA	LB37	LB37-SA	LL37	LL37-SA	LR37	LR37-SA	T37	T37-SA
1-1/4	C47	C47-SA	LB47	LB47-SA	LL47	LL47-SA	LR47	LR47-SA	T47	T47-SA
1-1/2	C57	C57-SA	LB57	LB57-SA	LL57	LL57-SA	LR57	LR57-SA	T57	T57-SA
2	C67	C67-SA	LB67	LB67-SA	LL67	LL67-SA	LR67	LR67-SA	T67	T67-SA
2-1/2	C77	C77-SA	LB77	LB77-SA	LL77	LL77-SA	LR77	LR77-SA	T77	T77-SA
3	C87	C87-SA	LB87	LB87-SA	LL87	LL87-SA	LR87	LR87-SA	T87	T87-SA
3-1/2	—	—	LB97	LB97-SA	LL97	LL97-SA	LR97	LR97-SA	T97	T97-SA
4	—	—	LB107	LB107-SA	LL107	LL107-SA	LR107	LR107-SA	T107	T107-SA

Hub Size (in.)	<b>E</b> 		<b>L*</b> 		<b>TA</b> 		<b>TB</b> 		<b>X</b> 	
	Grayloy-Iron	Aluminum	Grayloy-Iron	Aluminum	Grayloy-Iron	Aluminum	Grayloy-Iron	Aluminum	Grayloy-Iron	Aluminum
1/2	E17	E17-SA	L17	—	TA17	—	TB17	TB17-SA	X17	X17-SA
3/4	E27	E27-SA	L27	—	TA27	—	TB27	TB27-SA	X27	X27-SA
1	E37	E37-SA	L37	—	TA37	—	TB37	TB37-SA	X37	X37-SA
1-1/4	—	—	L47	—	TA47	—	TB47	TB47-SA	X47	X47-SA
1-1/2	—	—	L57	—	TA57	—	TB57	TB57-SA	X57	X57-SA
2	—	—	L67	—	TA67	—	TB67	TB67-SA	X67	X67-SA

\* L Unilets have double opening and are furnished with one steel cover, assembled.

### Appleton FM7 Blank Covers and Gaskets (Covers furnished with Stainless Steel Screws)

FM7 Body Size (in.)	Wedge-Lok Cast Cover 		Formtite Cast Cover with Integral Gasket 		Wedge-Lok Stamped Cover 		Formtite Stamped Cover with Integral Gasket 		Solid Neoprene Gasket 	
	Grayloy-Iron	Aluminum	Grayloy-Iron	Aluminum	Steel	Aluminum	Steel	Aluminum		
1/2	170F	170F-SA	170FG	170FG-SA	170	170-SA	170G	170G-SA	GASK571	
3/4	270F	270F-SA	270FG	270FG-SA	270	270-SA	270G	270G-SA	GASK572	
1	370F	370F-SA	370FG	370FG-SA	370	370-SA	370G	370G-SA	GASK573	
1-1/4	470F	470F-SA	470FG	470FG-SA	470	470-SA	470G	470G-SA	GASK574	
1-1/2	570F	570F-SA	570FG	570FG-SA	570	570-SA	570G	570G-SA	GASK575	
2	670F	670F-SA	670FG	670FG-SA	670	670-SA	670G	670G-SA	GASK576	
2-1/2	870F	870F-SA	870FG	870FG-SA	870	870-SA	870G	870G-SA	GASK578	
3	870F	870F-SA	870FG	870FG-SA	870	870-SA	870G	870G-SA	GASK578	
3-1/2	970F	970F-SA	970FG	970FG-SA	970	970-SA	970G	970G-SA	GASK579	
4	970F	970F-SA	970FG	970FG-SA	970	970-SA	970G	970G-SA	GASK579	

## FM7™ Conduit Body Dimensions

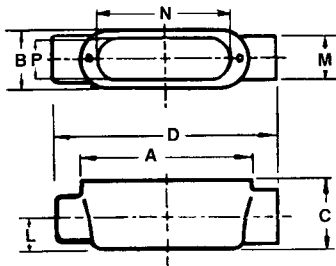

Type C

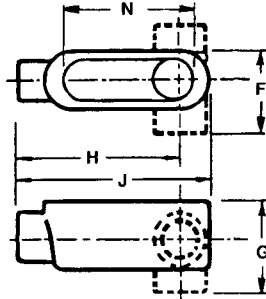

Types E, L, LB, LL, LR

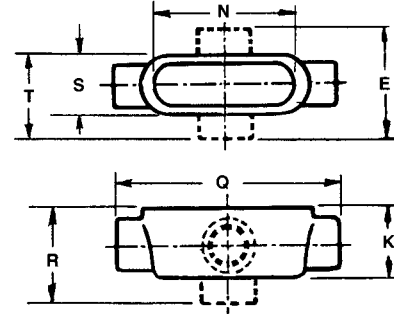

Types T, TA, TB, X

### Dimensions in Inches

Hub Size	A	B	C	D	E	F	G	H	J	K	L	M	N	P	Q	R	S	T
1/2	3.63	1.38	1.38	5.38	3.31	2.25	2.25	3.94	4.56	1.75	0.63	1.25	3.19	0.94	5.63	2.63	1.56	2.44
3/4	4.25	1.56	1.63	6.00	3.50	2.44	2.50	4.44	5.19	2.00	0.75	1.50	3.81	1.13	6.25	2.88	1.88	2.63
1	5.00	1.75	1.88	7.00	3.88	2.75	2.88	5.19	6.00	2.25	0.88	1.75	4.50	1.38	7.25	3.25	2.00	3.00
1-1/4	5.50	2.19	2.31	7.44	4.13	3.19	3.31	5.44	6.50	2.31	1.13	2.19	5.00	1.75	7.44	3.31	2.19	3.19
1-1/2	6.00	2.44	2.56	8.19	4.63	3.50	3.69	5.94	7.13	2.56	1.25	2.44	5.44	1.94	8.19	3.63	2.44	3.56
2	7.00	3.00	3.13	9.19	5.19	4.06	4.25	6.63	8.13	3.13	1.50	3.00	6.38	2.44	9.19	4.19	3.00	4.13
2-1/2	9.00	4.25	3.63	12.00	—	5.75	5.13	8.75	10.50	3.63	1.75	3.50	8.38	3.56	12.00	—	4.25	5.75
3	9.00	4.25	4.38	12.00	—	5.75	5.88	8.38	10.50	4.38	2.13	4.25	8.38	3.56	12.06	—	4.25	5.75
3-1/2	11.00	5.25	4.88	—	—	6.94	6.56	10.25	12.69	4.88	2.38	4.75	10.25	4.50	14.31	—	5.25	6.94
4	11.00	5.25	5.38	—	—	6.94	7.06	10.00	12.69	5.38	2.63	5.25	10.25	4.50	14.31	—	5.25	6.94

### Fraction/Decimal Equivalents (Inches)

Fraction	Decimal	Fraction	Decimal	Fraction	Decimal	Fraction	Decimal
1/16	0.06	5/16	0.31	9/16	0.56	13/16	0.81
1/8	0.13	3/8	0.38	5/8	0.63	7/8	0.88
3/16	0.19	7/16	0.44	11/16	0.69	15/16	0.94
1/4	0.25	1/2	0.50	3/4	0.75	1	1.00

Appleton's family of conduit bodies gives you **FREEDOM OF CHOICE.**



FM7™ Grayloy-Iron and Aluminum. Threaded, available with a complete selection of stamped or cast covers, plus solid gasket.



Form 35® malleable iron. Threaded and no-thread types, with a complete selection of covers, gaskets, and wiring devices.



Form 85™ aluminum. Threaded and setscrew types, with a complete selection of covers, gaskets, and wiring devices.



NEC Mogul 6x8x, plus LBDN pulling Unilets, aluminum or malleable. Furnished with cover and gasket, meet NEC length and bending space requirements for large and heavy conductors. Mogul LL, LR and T types. Aluminum or malleable iron. With cover and gasket.

## Wiring Capacity: FM7™ and FM8® Conduit Bodies and Covers

Combine Body and Cover Capacities for Total usable Capacity per NEC 370-6(a)(1)

### FM7™ Grayloy™ – Iron Bodies and Covers: Threaded

#### Capacity in Cubic Inches

Hub Size (In.)	C	E	LB	LL LR	L	T	TA	TB	X	Stamped Cover	Cast Cover
1/2	4.0	4.0	4.0	4.0	5.0	6.0	6.0	6.0	6.0	0.3	0.4
3/4	7.0	7.0	7.0	7.0	9.0	10.0	10.0	10.0	10.0	0.5	0.8
1	11.0	11.0	11.0	11.0	13.5	15.5	15.5	15.5	15.5	1.3	1.3
1-1/4	20.0	—	20.0	20.0	22.5	20.0	20.0	20.0	20.0	1.8	2.0
1-1/2	28.0	—	28.0	28.0	31.0	28.0	28.0	28.0	28.0	2.3	3.0
2	50.0	—	50.0	50.0	55.0	50.0	50.0	50.0	50.0	2.8	4.8
2-1/2	102.0	—	102.0	102.0	—	102.0	—	—	—	9.8	9.7
3	133.0	—	133.0	133.0	—	133.0	—	—	—	9.8	9.7
3-1/2	—	—	218.0	218.0	—	218.0	—	—	—	16.5	16.0
4	—	—	244.0	244.0	—	244.0	—	—	—	16.5	16.0

### FM7™ Aluminum Bodies and Covers: Threaded

#### Capacity in Cubic Inches

Hub Size (In.)	C	E	LB	LL LR	L	T	TA	TB	X	Stamped Cover	Cast Cover
1/2	4.0	4.0	4.0	4.0	—	6.0	—	6.0	6.0	0.3	0.4
3/4	7.0	7.0	7.0	7.0	—	10.0	—	10.0	10.0	0.5	0.8
1	11.0	11.0	11.0	11.0	—	15.5	—	15.5	15.5	1.3	1.3
1-1/4	20.0	—	20.0	20.0	—	20.0	—	20.0	20.0	1.8	2.0
1-1/2	28.0	—	28.0	28.0	—	28.0	—	28.0	28.0	2.3	3.0
2	50.0	—	50.0	50.0	—	50.0	—	50.0	50.0	2.8	4.8
2-1/2	102.0	—	102.0	102.0	—	102.0	—	—	—	9.8	9.7
3	133.0	—	133.0	133.0	—	133.0	—	—	—	9.8	9.7
3-1/2	—	—	218.0	218.0	—	218.0	—	—	—	16.5	16.0
4	—	—	244.0	244.0	—	244.0	—	—	—	16.5	16.0

### FM8® Grayloy™ – Iron Bodies and Covers: Threaded

#### Capacity in Cubic Inches

Hub Size (In.)	C	E	LB	LL LR	L	T	TA	TB	X	Stamped Cover	Cast Cover
1/2	5.0	—	5.0	5.0	—	6.0	—	6.0	6.0	0.5	0.3
3/4	8.0	—	8.0	8.0	—	10.0	—	10.0	10.0	0.8	0.8
1	13.0	—	13.0	13.0	—	15.0	—	15.0	15.0	1.0	1.0
1-1/4	24.0	—	24.0	24.0	—	25.0	—	25.0	25.0	1.5	1.5
1-1/2	42.5	—	42.5	42.5	—	44.0	—	44.0	44.0	1.8	7.5
2	105.0	—	105.0	105.0	—	105.0	—	105.0	105.0	4.5	12.5
2-1/2	200.0	—	200.0	200.0	—	200.0	—	—	—	12.3	34.5
3	217.0	—	217.0	217.0	—	217.0	—	—	—	12.3	34.5
3-1/2	—	—	380.0	—	—	—	—	—	—	24.0	65.3
4	—	—	400.0	—	—	—	—	—	—	24.0	65.3