

Electrical Accessories

V

Night Lights	V-1
Interchange Switches & Pilot Lights	V-2
Interchange Devices	V-3
Interchange Wallplates	V-4
Wallplates/Interchange Line	V-5
Wire Connectors	V-6
Heater Elements	V-7
Miscellaneous Electrical Accessories	V-8
Miscellaneous Accessories	V-9
Wallplate Accessories	V-10



From night lights, heating elements, and wire connectors...to safety caps and circuit testers...to interchange switches, devices and wallplates, our electrical accessories cover a broad range of needs. And each of these items is manufactured to the same rigorous quality standards that distinguish every Cooper Wiring Devices product.

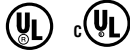

Night Lights

On/Off Switch,
Automatic, Accessories

Night Lights

FEATURES

- Soft action rocker switch.
- Incandescent 4-watt bulb – 3,000 hour lamp life.
- Body and shade molded of heat-resistant plastic.
- Shade can rotate 360°.



850

Night Lights

Rating		Description	Bulb	Color	Catalog No.
A	V/AC				
15	125	With On/Off Switch	4 Watt Incandescent	Blue	850BL
				Brown	850B
				Ivory	850V
				Rose	850R
				White	850W

Automatic Night Lights

FEATURES

- Photo sensor automatically lights – “on” at dusk, “off” at dawn.
- Incandescent 4-watt bulb – 3,000 hour lamp life.
- Body and shade molded of heat-resistant plastic.



851BGE

Automatic Night Lights

Rating		Description	Bulb	Color	Catalog No.
A	V/AC				
15	125	Automatic	4 Watt Incandescent	Beige	851BGE
				White	851W
15	125	Button	.3 Watt Neon	Clear	854
15	125	Jewel	.3 Watt Neon	Clear	857

Night Light Accessories

Replacement Bulb – 4 Watt

Rating Watts	V/AC	Description	Fits	Color	Catalog No.
4	125	Candelabra Base	850, 851	Clear	504

Night Light Clip to Add Customized Shade

Description	Fits	Color	Catalog No.
Plastic Clip to Add Customized Shade	850 Base	Ivory	850CP
		Clear	850CL



854



850

INDUSTRIAL
COMMERCIAL
RESIDENTIAL

V-1
ELECTRICAL
ACCESSORIES

TESTING & CODE COMPLIANCE

- UL Listed (file no. E132919).
- CSA certified (file no. 54791 (3431-01)).
- Meets all CSA requirements, C22.2 no. 12.1.
- 851BGE: UL and cUL Listed (file no. E177013).
- NOM Certified.

MATERIAL CHARACTERISTICS

Meets flammability requirements per UL 94, VO rated.
 Temperature Rating:
 -20°C to 60°C,
 except 851BGE:
 -20°C to 70°C.

Interchange Switches & Pilot Lights



INDUSTRIAL
COMMERCIAL
RESIDENTIAL

V-2
ELECTRICAL
ACCESSORIES

TESTING & CODE COMPLIANCE

Interchange Switches:
 · UL Listed (file no. E18704).
 · CSA Certified (file no. 10016 (6241-05)), except as noted. Meets all CSA requirements, C22.2 no. 111.
 Pilot Lights:
 · Listed to UL 498, 1720/1722: (file no. E47921).
 · CSA Certified to C22.2 no. 43 (file no. LR6729).

MATERIAL CHARACTERISTICS

Interchange Switches:
 Flammability per UL 94.
 Temperature Rating: -40°C to 65°C.
 Pilot Lights:
 1720/1722:
 Temperature Rating: -40°C to 150°C.

Interchange Switches

FEATURES

- Side wire and push wire terminals accept #12 or #14 solid wire.
- Combination slot/Phillips head terminal screws.
- Compatible with all standard interchangeable products.
- Touch-A-Matic® spring-loaded steel ball action for smooth, positive contact movement.
- Molded of either unbreakable thermoplastic or heat-resistant thermoset plastic for smooth, scratch-resistant finish and excellent electrical properties.

AC Quiet Switches – Push Wire

A	V/AC	Description	Color	Catalog No.	
				Single Pole	3-Way
15	120	1/2 HP-120V/AC	Brown	1101B*	1103B*
			Ivory	1101V*	1103V*
20	120-277V	1 HP-120V/AC	Ivory	1121V*	1123V*
		2 HP-240V/AC			

*Not CSA certified.

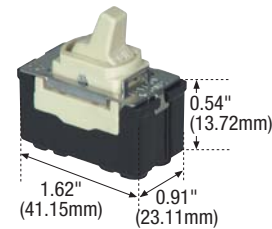

1101

AC-DC Quiet Switches – Side Wire

A	V/AC – V/DC	Color	Catalog No.	
			Single Pole	3-Way
10	125	Brown	907B	923B
5	250	Ivory	907V	923V
10	125 "T"	Brown	901B	903B
5	250	Ivory	901V	903V

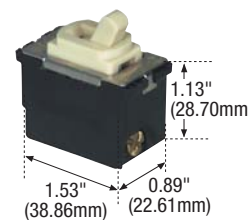

907

Pilot Lights

FEATURES

- Flush neon type with Lexan® jewels.
- Fits all standard single switch plates.

Pilot Lights

Rating Watts	V/AC	Description	Color	Catalog No.
1/25	125	Brown Base	Red	1720RD
			Green	1720GN
			Amber	1720AMB
1/25	220/277	Brown Base	Red	1722RD
			Green	1722GN
			Amber	1722AMB



1720



Interchange Devices

Interchange Devices

FEATURES

- Combination slot/Phillips head terminal screws.
- Incandescent pilot light hood is polished finish.
- Grounding receptacles have patented automatic grounding to mounting strap.
- Compatible with all standard interchange devices.

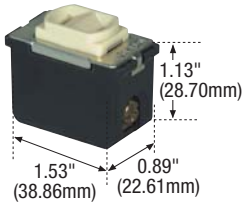

902

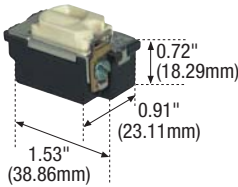

967



905



935

Receptacles – Side Wire

Rating	A	V/AC	NEMA	Description	Color	Catalog No.
15 1/2 HP	125	1-15R	Two Wire	Brown	902B	
15 1/2 HP	125	5-15R	Three Wire	Ivory	902V	
15 1/2 HP	125	5-15R	Three Wire	Brown	967B*	
15 1/2 HP	125	5-15R	Three Wire	Ivory	967V*	

*Not UL Listed

Pilot Lights – Side Wire

Rating	Watts	V/AC	Description	Color	Catalog No.
75	125		Incandescent Candelabra	Silver	905

Bulbs – Candelabra

Rating	Watts	V/AC	Description	Color	Fits	Catalog No.
6	120		Incandescent Candelabra	Clear	905, 799, 153	936C

Blank Inserts for Interchange Devices

FEATURES

- Covers unused openings in wallplates.

Blank Inserts

Description	Color	Catalog No.
Snap-in Insert	Ivory	935V



1-15R



5-15R

INDUSTRIAL
COMMERCIAL
RESIDENTIAL

V-3
ELECTRICAL
ACCESSORIES

TESTING & CODE COMPLIANCE

· UL Listed (file no. E15058), meets all UL 498 requirements, except as noted.
· 905: UL Listed (file no. E26358), and CSA Certified (file no. 1739 (6231-05)).

MATERIAL CHARACTERISTICS

Temperature Rating:
-40°C to 65°C.

Interchange Wallplates



INDUSTRIAL
COMMERCIAL
RESIDENTIAL

V-4
ELECTRICAL
ACCESSORIES

MATERIAL CHARACTERISTICS
Temperature Rating:
-40°C to 65°C.

Commercial Thermoset Interchange Wallplates

FEATURES

- Wallplates furnished with mounting straps. ■ Matching mounting screws provided.
- Made of heat-resistant thermoset phenolic or urea.

Specification Grade Thermoset Interchange Wallplates

1 Gang 1 Device

Description	Color	Catalog No.
Vertical Opening	Ivory	957V
Horizontal Opening	Ivory	951V

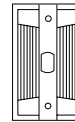

1 Gang 2 Device

Description	Color	Catalog No.
Horizontal Openings	Brown	952B
	Ivory	952V

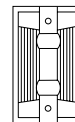

1 Gang 3 Device

Description	Color	Catalog No.
Horizontal Openings	Brown	953B
	Ivory	953V

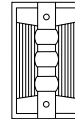

2 Gang 4 Device

Description	Color	Catalog No.
Horizontal Openings	Ivory	954V

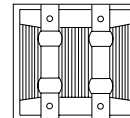

2 Gang 6 Device

Description	Color	Catalog No.
Horizontal Openings	Ivory	956V

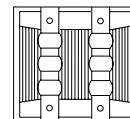

Mounting Straps - Metal

Description	Catalog No.
Single Vertical Opening	911
Triple Horizontal Openings	913





INDUSTRIAL
COMMERCIAL
RESIDENTIAL

V-5
ELECTRICAL
ACCESSORIES

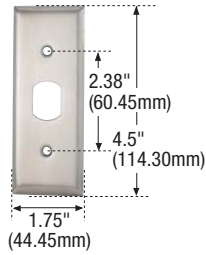

T1650

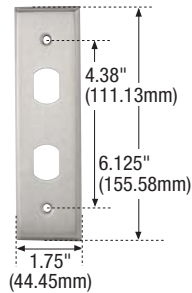

T1652

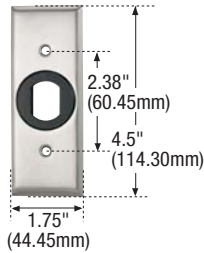

T16500

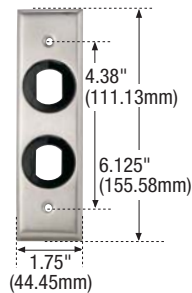

T16520

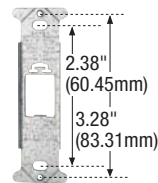

T1657

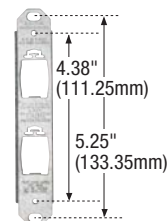

T1661

Wallplates/Interchange Line

"Trim-Line" Interchangeable 302 Stainless Steel Wallplates

FEATURES

- Type 302 stainless steel alloy for superior non-magnetic corrosion-resistant properties.

302 Stainless Steel

1.75" (44.45mm) Wide

Description	Use with	Catalog No.
One Vertical opening	Switches and Pilot Lights Only	T1650
Two vertical openings		T1652
Blank, one gang		T1674

1.75" (44.45mm) Wide with Insulated Adapters

Description	Use with	Adapter Color	Catalog No.
One Vertical opening with adapter	902 and 967 Receptacles, Switches and Pilot Lights	Brown	T16500B
		Ivory	T16500V
Two vertical openings with adapters		Brown	T16520B
		Ivory	T16520V
Insulating adapter insert only		Brown	T1327
		Ivory	T1427

Plate Mounting Straps

Mounting straps are NOT included with "TRIM-LINE" plates. Must be ordered separately.

Description	Catalog No.
One Vertical opening	T1657
Two vertical openings	T1661

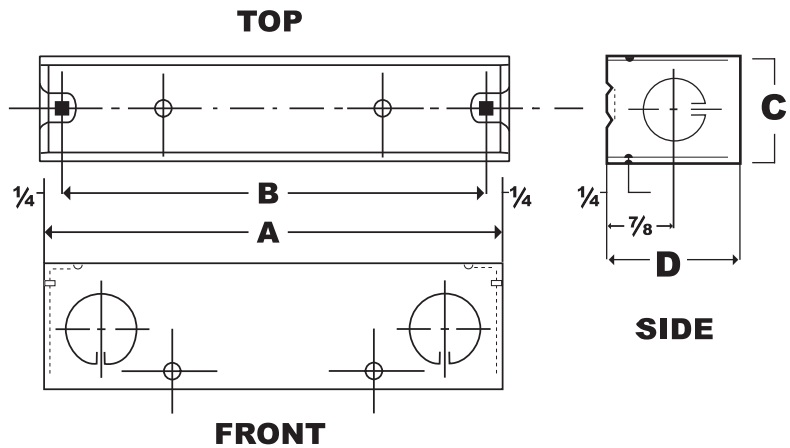

Wall Boxes for "Trim-Line" Wallplates for Partition and Channel Mounting

A	B	C	D
3.781" (96.04mm)	3.28" (83.31mm)	1.313" (33.35mm)	1.625" (41.275)
5.75" (146.05mm)	5.25" (133.35mm)	1.313" (33.35mm)	1.625" (41.275)

NOTE: Boxes are not supplied by Cooper Wiring Devices.

Wire Connectors



INDUSTRIAL
COMMERCIAL
RESIDENTIAL

V-6
ELECTRICAL
ACCESSORIES

TESTING & CODE COMPLIANCE

· UL Listed
(file no. E5981).

MATERIAL CHARACTERISTICS

Meets flammability requirements per UL 94, VO rated.
Temperature Rating: -20°C to 60°C.

Wire Connectors

FEATURES

- Molded of rugged, impact-resistant thermoplastic.
- Helical tin-plated spring assures secure connection.
- Heavy ribbed body for easy gripping.
- Suitable for solid or stranded copper wire.
- Temperature rating of 105°C.

Twist-On Wire Connectors

Description/Wire Sizes	Building Wire	Signs and Fixtures	Color	Catalog No.
Small #18 & #16	300V	300V	Orange Black	33-3 33
Medium #18 to #12	600V	1000V	Yellow Black	44-3 44
Large #18 to #10	600V	1000V	Red Black	66-3 66
Jumbo #14 to #8	600V	1000V	Gray Black	99-3 99



66-3

Wire Connectors Chart

Dimensions, Numbers and Sizes of Wire Accommodated

Except as noted, combinations are for solid or stranded copper wires.

Size	Cat.No./Color	Strip Wires	#8	#10	#12	#14	#16	#18
Jumbo 0.734" (18.65mm) x 1.25" (31.75mm)	99 Black or 99-3 Gray	0.75" (19.05mm)	1 with	1	or 1	or 2		
			-	2 to 3	or 3 to 4	or 5		
				1 with	2	or 3		
				2 with	1	or 1		
				1 Sol. with	4 Sol.	-	-	
			1 with	3				
2 with	2							
3 with	1							
Large 0.656" (16.668mm) x 1.0625" (26.987mm)	66 Black or 66-3 Red	Solid 0.50" (12.70mm) Strand 0.75" (19.05mm)	2	or 2 to 3	or 2 to 4 Sol.	-	or 6 Sol.	
			1 Sol. with	-	2 Sol.	or 1 to 3 Sol.	-	
			1 Sol. with	-	-	1 to 4 Sol.	-	
			1 with	-	-	or 1 to 3	-	
			2 Sol. with	-	-	1 Sol.	-	
			-	1 with	2	or 2 to 4	-	
				2 with	1	or 2	or 2	
				3 Sol.	-	-	-	
Medium 0.531" (13.49mm) x 0.906" (23.019mm)	44 Black or 44-3 Yellow	#16 & #18 Strand 0.4375" (11.112mm) Others 0.375" (9.525mm)	-	-	-	2 to 3 Sol.	or 2 to 4	or 3 to 5
			1 with	-	-	1	or 1	
			1 Sol. with	-	-	2 Sol.	-	
			-	1 with	1 to 2	or 1 to 2		
				2	-	-		
				-	1 to 2 with	2		
				-	2 with	1 to 2		
-	1 to 3 Sol. with	1 Sol.						
-	1 with	1 to 3						
Small 0.4375" (11.112mm) x 0.75" (19.05mm)	33 Black or 33-3 Orange	#16 or #18 Strand 0.5625" (14.288mm) Others 0.50" (12.70mm)	-	-	-	-	2 to 3	or 2 to 5
			1 with	1	or 1 to 3			
			-	1 with	3 to 4			
			-	1 to 2 with	1 to 2			
			-	-	-			



Heater Elements

**Glocoil®,
Heater Receptacle,
Lighter Element**

Heater Elements

FEATURES

- Used for testing equipment when additional wattage or amperage is needed.
- Shell constructed of high-temperature porcelain.
- Heater receptacle constructed of high-temperature porcelain.

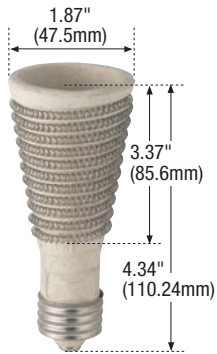

415A-120



602



444-120

Glocoil® Elements

Watts	Description	Catalog No.	
		120 Volts	220 Volts
600 to 660	Conical	415A-120-660	415A-220-660
1000	Conical	415A-120-1M	—
600 to 660	Straight	415-120	415-220
1000	Straight Industrial	411	411-2

Heater Receptacle

Rating Watts	V/AC	Description	Catalog No.
660	250	2 Piece Porcelain	602

Lighter Element

FEATURES

- For use where open flame is restricted as in prisons, laboratories and other institutions.

Lighter Elements

Rating Watts	V/AC	Description	Catalog No.
85	120	Medium Base	444-120

INDUSTRIAL
COMMERCIAL
RESIDENTIAL

V-7
ELECTRICAL
ACCESSORIES

TESTING & CODE COMPLIANCE

- Cat. No. 602:
UL Listed
(file no. E7430.
Meets all UL 496
requirements.
- CSA Certified
(file no. 1739
(6231-07)).
Meets all
CSA requirements,
C22.2 no. 43.
- NOM Certified.
- 415A-120 and
415-120 are CSA
Certified (file no.
2254 (2871-02)).

Miscellaneous Electrical Accessories

Circuit Tester
Safety Caps
Tamper Resistant Wallplate Cover



Circuit Tester

FEATURES

- For testing electric circuits from 90-600 V AC-DC.
- Detects presence of power on either AC or DC circuits.
- Identifies circuit conductors.
- Rugged polycarbonate plastic construction.

Circuit Tester		
Description	Color	Catalog No.
Circuit Tester	Blue	914



914

Safety Caps

FEATURES

- Increases child safety by covering electrical outlets when not in use by restricting access to live parts.
- Constructed of impact-resistant thermoplastic.

Safety Caps	
Color	Catalog No.
Clear	29CL



29CL

Tamper Resistant Wallplate Cover

FEATURES

- For National Electric Code® compliance, and a valued alternative to specifying tamper resistant receptacles, Cooper Wiring Devices offers CSA Certified (LR84964) tamper resistant covers in both ivory and white colors.

Tamper Resistant Cover			
Description	NEMA	Color	Catalog No.
Duplex Receptacle Safety Wallplate	5-15R	Ivory	TRW15V
		White	TRW15W

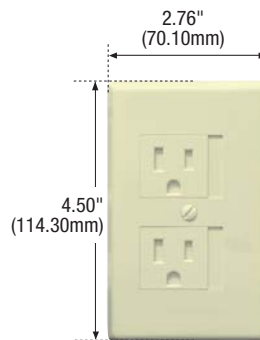

TRW15V

INDUSTRIAL
COMMERCIAL
RESIDENTIAL

V-8
ELECTRICAL
ACCESSORIES

TESTING & CODE COMPLIANCE

· 914: UL Listed (file no. E143353). Meets all UL 1436 requirements.
29CL: UL Listed (file no. E13251). Meets all UL 2255 requirements.
Wallplate Cover: UL Listed (file no. E125384), meets all UL 514D requirements.

MATERIAL CHARACTERISTICS

Meets flammability requirements per UL 94, V2 rated.
Temperature Rating: -40°C to 70°C.
Wallplate Cover: Meets flammability requirements per UL 94, VO rated.
Temperature Rating: -20°C to 70°C.



5-15R



INDUSTRIAL
COMMERCIAL
RESIDENTIAL

V-9 ELECTRICAL ACCESSORIES

MATERIAL CHARACTERISTICS

Cat. No.'s 87 & 88

Environmental:

Flammability
per UL 94
requirements,
V2 rated.

Temperature Rating:
-40°C to 80°C.

Bushings:

Meets flammability
requirements per
UL 94, VO rated.

Temperature Rating:

76 and 77:

-20°C to 70°C,

28 and 30:

-20°C to 60°C.



2529C



2530



7949



756



76



28

Miscellaneous Accessories

Plate Screws and Key

FEATURES

- All screws are #6-32.

Spanner Head

Description	Finish	Length	Catalog No.
Tamper resistant	Chromium	13/32" (10.319mm)	2529C
Key for 2529C	—		2530

Metal Switch Lever Guard

FEATURES

- Nickel finish
- For flush tumbler switch levers
- Attaches to standard plates by the plate screws

Metal Switch Lever Guard

Description	Catalog No.
Switch lever guard with 1/4" padlock holes	7949

Sub-Frame and Blank Insert

Description	Color	Catalog No.
Blank insert and strap for standard switch plate	Brown	756B
	Gray	756GY
	Ivory	756V
	Light Almond	756LA
	White	756W

Bushings

FEATURES

- Provide smooth protective surface for cords or wires passing through knockouts.

Bushings

Description	Knockout Size	Inside Diameter	Outside Diameter	Groove	Catalog No.
Rubber	0.375" (9.525mm)	0.375" (9.525mm)	0.75" (19.05mm)	0.50" (12.70mm)	76
Rubber	0.50" (12.70mm)	0.50" (12.70mm)	1.031" (26.19mm)	0.875" (22.225mm)	77
Plastic with Lock Nut	0.50" (12.70mm)	0.50" (12.70mm)	—	—	28
Plastic with Lock Nut	0.75" (19.05mm)	0.75" (19.05mm)	—	—	30

Wallplate Accessories

Adapters, Wallplate Screws,
Plastic Bull's Eyes,
Pilot Light Lampholder



INDUSTRIAL
COMMERCIAL
RESIDENTIAL

V-10
ELECTRICAL
ACCESSORIES

Wallplate Accessories

FEATURES

- Wall protectors are constructed of attractive, clear plastic and fit snug under standard wallplate.
- Adapters are designed to fit Decorator openings and convert them to fit other devices.

Wall Protectors

Description	Color	Catalog No.
1 Gang	Clear	1130*
2 Gang	Clear	1142*

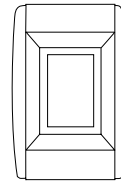

Adapters

Description	Color	Catalog No.
Decorator to Blank	Almond	2160A
	Brown	2160B
	Ivory	2160V
	Light Almond	2160LA
	White	2160W
Decorator to Dimmer or Toggle	Almond	2161A
	Brown	2161B
	Ivory	2161V
	Light Almond	2161LA
	White	2161W

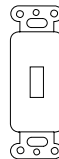

Wallplate Screws

Description	Use with	Color	Catalog No.
#6-32 x 1/2" (12.7mm) Baked Enamel	Toggle & Receptacle Wallplates	Almond	231A
		Brown	231B
		Ivory	231V
		Light Almond	231LA
		White	231W
Brass Plated Steel Stainless Steel	Toggle & Receptacle Wallplates	Brass	231BD
		Stainless	231SS
		#6-32 x 1/2" (12.7mm) Nylon	Toggle & Receptacle Wallplates
Ivory	232V		
Light Almond	232LA		
White	232W		
#6-32 x 5/16" (7.94mm) Baked Enamel	Decorator Wallplates	Almond	2231A
		Ivory	2231V
		Light Almond	2231LA
		White	2231W
		Stainless Steel	2231SS



Plastic Bull's Eyes

Description	Fits	Color	Catalog No.
Rectangular Indicator Light	Toggle Wallplate	Red	156
Round Indicator Light	Single Receptacle Wallplate	Red	157

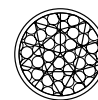
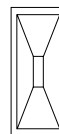

Pilot Light Lampholder

Description	Use with	Catalog No.
Recessed Pilot Light with 6 Watt Clear S-6 Bulb	Louwer Wallplate (see page 0-4)	153*

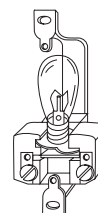

*Not UL Listed. Not CSA Certified. Not NOM.