





# IEC Control and Load Switches

## Product Selection/Catalog Number Explanation

### Bulletin 194L Control and Load Switches

Base/DIN Rail Mounting	Front/Door Mounting	Base/DIN Rail Mounting	Front/Door Mounting	Front/Door Mounting
				
12...25 A Base Mount	12...25 A Front Mount	32 A and 40 A Base Mount	32 A and 40 A Front Mount	32 A and 40 A Front Mount, for use with 22.5 mm mounting hole style handle

### Catalog Number Explanation

194L - A 16 - 175 3

a                      b                      c                      d



a

Installation Type	
Code	Description
A	Base/DIN Mounting
E	Front/Door Mounting
C	Front/Door Mounting (For use with 32 A and 40 A switches only. Use when selecting 22.5 mm hole-mounting style handle.)

b

Load Size			
Code	Description	Code	Description
12	12 A	25	25 A
16	16 A	32	32 A
20	20 A	40	40 A

c

Code	Function	Configuration	Use with Switch Style*⊛:	Circuit Diagram Ref. No.
150	On/Off	2-Position (60 degrees)	194L-E, 12...40 A, 1...6 poles	1501...1506
175		2-Position (90 degrees)	194L-E or 194L-A, 12...40 A, 1...6 poles	1751...1756
178		2-Position (90 degrees-inverted)	194L-E or 194L-A, 12...40 A, 1...4 poles	1781...1784
225	Change-Over	1-2 (without 0, 45 degrees)	194L-E, 12...40 A, 1...5 poles or 194L-A, 12...40 A, 1...2 poles	2251...2255
250		1-2 (without 0, 60 degrees)	194L-E, 12...40 A, 1...5 poles	2501...2505
300		1-0-2 (with 0, 30 degrees, spring return)	194L-E, 12 A, 1...3 poles	3001...3003
325		1-0-2 (with 0, 45 degrees)	194L-E or 194L-A, 12...40 A, 1...4 poles	3251...3254
326		1-0-2 (with 0, 45 degrees, spring return)	194L-E, 12 A, 1...3 poles	3261...3263
350		1-0-2 (with 0, 60 degrees)	194L-E, 12...40 A, 1...4 poles	3501...3504
375		1-0-2 (with 0, 90 degrees)	194L-E, 12...40 A, 1...4 poles	3751...3754
425	Step Switch	1-2-3 (45 degrees)	194L-E or 194L-A, 12...40 A, 1 pole 194L-E, 12...40 A, 2...3 poles	4251...4253
426		1-2-3-4 (45 degrees)	194L-E, 12...40 A, 1...3 poles 194L-A, 12...40 A, 2 poles	4261...4263
427		1-2-3-4-5 (45 degrees)	194L-E or 194L-A, 12...40 A, 1 pole	4271
428		1-2-3-4-5-6 (45 degrees)	194L-E or 194L-A, 12...40 A, 1 pole	4281
450		1-2-3 (60 degrees)	194L-E, 12...40 A, 1...3 poles	4501...4503
451		1-2-3-4 (60 degrees)	194L-E, 12...40 A, 1...3 poles	4511...4513
452		1-2-3-4-5 (60 degrees)	194L-E, 12...40 A, 1 pole	4521
453		1-2-3-4-5-6 (60 degrees)	194L-E, 12...40 A, 1 pole	4531
500		0-1-2-3-4 (30 degrees)	194L-E, 12...40 A, 1...3 poles	5001...5003
501		0-1-2-3-4-5 (30 degrees)	194L-E, 12...40 A, 1...3 poles	5011...5013
525		0-1-2 (45 degrees)	194L-E or 194L-A, 12...40 A, 1 pole 194L-E, 12...40 A, 2...3 poles	5251...5253
526		0-1-2-3 (45 degrees)	194L-E or 194L-A, 12...40 A, 1 pole 194L-E, 12...40 A, 2...3 poles	5261...5263
527		0-1-2-3-4 (45 degrees)	194L-E or 194L-A, 12...40 A, 1 pole 194L-E, 12...40 A, 2...3 poles	5271...5273
528		0-1-2-3-4-5 (45 degrees)	194L-E or 194L-A, 12...40 A, 1 pole 194L-E, 12...40 A, 2...3 poles	5281...5283
550		0-1-2 (60 degrees)	194L-E, 12...40 A, 1...3 poles	5501...5503
551	0-1-2-3 (60 degrees)	194L-E, 12...40 A, 1...3 poles	5511...5513	
552	0-1-2-3-4 (60 degrees)	194L-E, 12...40 A, 1...3 poles	5521...5523	
553	0-1-2-3-4-5 (60 degrees)	194L-E, 12...40 A, 1...3 poles	5531...5533	
725	Star-Delta (Wye-Delta)	0-Y-Δ (45/90 degrees)	194L-E or 194L-A, 12...40 A, 3 poles	7253
732		0-Y-Δ (45/90 degrees)	194L-E or 194L-A, 12...40 A, 3 poles	7323
750		0-Y-Δ (60 degrees)	194L-E, 12...40 A, 3 poles	7503
730	Reversing	1-0-2 (45 degrees)	194L-E or 194L-A, 12...40 A, 3 poles	7303
754		1-0-2 (60 degrees)	194L-E, 12...40 A, 3 poles	7543
825	Voltmeter	0-RN-SN-TN-TR-ST-RS (45 degrees)	194L-E or 194L-A, 12 A, 1 pole	8251
827		0-RS-ST-TR (45 degrees)	194L-E or 194L-A, 12 A, 1 pole	8271
875	Ammeter	0-1-2-3 (90 degrees)	194L-E or 194L-A, 12 A, 1 pole	8751
876		0-1-2-3-4 (90 degrees)	194L-E or 194L-A, 12 A, 1 pole	8761
877		0-1 (90 degrees inverted)	194L-E or 194L-A, 12 A, 1 pole	8771

d

No. of Poles	
Code	Description
1	1 Pole
2	2 Poles
3	3 Poles
4	4 Poles
5	5 Poles
6	6 Poles

\* Not all possible configurations are available. Some configurations may have longer delivery times and minimum order quantities.  
 ⊛ When choosing front mount style 194L-E for 32 A or 40 A, use the 194L-C code only if a 194L-HC style handle is being used.

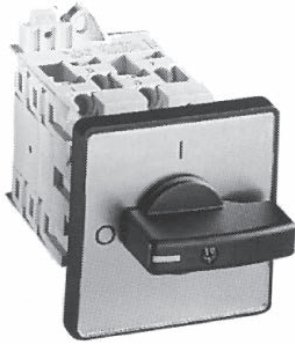

## Bulletin 194L IEC Control and Load Switches

- 12, 16, 20, 25, 32, and 40 A inductive load-rated switch
- IP66 water spray and dustproof handles
- IP20 finger-safe terminals
- Switches available for OFF-ON, changeover, star-delta (wye-delta), reversing, ammeter, voltmeter and step switch configurations
- 1...6-Pole versions
- Front/door- or base/ DIN Rail-mounting configurations
- Thermoplastic enclosures IP66
- Suitable as motor disconnect (UL 508)

Bulletin 194L control and load switches are flexible, adaptable, time- and space-saving devices. Switches are available as front/door- or Base/DIN rail-mounting versions. Uniformly styled handles, featuring marked legend plates, are available in Selector-Knob, Disk-Style, Rectangular-Style and Key-Operated versions. Selector-Knob versions are available in three sizes. Most handles are available in grey/black or red/yellow and have padlockable versions.

A new thermoplastic enclosure features constructions of impact-resistant ABS or corrosion resistant NORYL materials. Both shallow and deep versions include 35 mm DIN mounting Rail, grounding and neutral terminals, and captive cover screws. Enclosures may be ordered with or without cover openings for handle mounting. Enclosures are rated for use in IP66 (UL Type 1, 3, 3R, 12) environments.

## Table of Contents

Product Overview ..... this page  
 Product Selection ..... 2-435  
 Accessories..... 2-440  
 Switching Diagrams.. 2-442  
 Specifications..... 2-448  
 Approximate Dimensions..... 2-449

### Standards Compliance

IEC 60947-3 Low-voltage switchgear and control gear part 3  
 UL 508  
 CSA: C22.2 No. 14

### Certifications

UL Listed (File No. E14841, Guide NLRV)  
 CSA Certified (LR 13908)  
 Meets IEC, VDE and BS Standard requirements  
 CE

### Product Overview



**OFF-ON Switch**

#### OFF-ON Switch

Two-position switch used to connect or disconnect a variety of inductive loads including: solenoids, handles, valves, magnetic starters and relays.



**Star-Delta (Wye-Delta) Switch**

#### Star-Delta (Wye-Delta) Switch

Three-position (Off-Wye-Delta) switch used to manually control reduced-voltage motor starting. Operating the switch manually changes the wiring configuration of the motor from a star configuration to delta configuration after the controller operator has determined that the motor is up to operating speed.



**Ammeter Switch**

#### Ammeter Switch

Multi-position switch used to connect one or more phases of an electrical supply to an ammeter, so that the current in each phase can be displayed on one ammeter.



**Step Switch**

#### Step Switch

Multi-position switch used to connect a variety of loads to an electrical supply in a pre-determined logical sequence. A typical application would be temperature control of a heating oven or furnace.



**Changeover Switch**

#### Changeover Switch

Two-position switch used in control applications to change between alternate power supplies. This device can typically be used to manually switch power supplies from a primary source to a stand-by/emergency supply in the event of a power outage.



**Voltmeter Switch**

#### Voltmeter Switch

Multi-position switch used to connect two lines of the electrical supply system to a voltmeter so that the voltage between the lines (phase-to-phase or phase-to-neutral) can be displayed on one voltmeter.



**Reversing Switch**

#### Reversing Switch

Three-phase, three-position (Forward-Off-Reverse) switch used to manually control a motor's direction of rotation. Operating the switch changes the wiring configuration of the motor to operate in the forward or reverse direction.

*d*

2

Code	Description	Legend Marking	Code	Description	Legend Marking	Code	Description	Legend Marking
150	O-I		426	1-2-3-4 (45° Step Switch)		551	0-1-2-3 (60° Step Switch)	
150I	OFF-ON		427	1-2-3-4-5 (45° Step Switch)		552	0-1-2-3-4 (60° Step Switch)	
175	O-I		428	1-2-3-4-5-6 (45° Step Switch)		553	0-1-2-3-4-5 (60° Step Switch)	
175I	OFF-ON		450	1-2-3 (60° Step Switch)		725	0-Y-Δ (45°/90° Star-Delta Switch)	
178	O-I		451	1-2-3-4 (60° Step Switch)		732	0-Y-Δ (45°/90° Star-Delta Switch)	
178I	OFF-ON		452	1-2-3-4-5 (60° Step Switch)		750	0-Y-Δ (60° Star-Delta Switch)	
225	1-2 (45° Changeover without O)		453	1-2-3-4-5-6 (60° Step Switch)		754	Same as Code 350. Use order code 350.	
250	1-2 (60° Changeover without O)		500	0-1-2-3-4 (30° Step Switch)		825	0-RN-SN-TN-TR-ST-RS (45° Voltmeter Switch)	
300	1-0-2 (30° Changeover with spring return)		501	0-1-2-3-4-5 (30° Step Switch)		827	0-RS-ST-TR (45° Voltmeter Switch)	
325	1-0-2 (45° Changeover with O)		525	0-1-2 (45° Step Switch)		875	0-1-2-3 (90° Ammeter Switch — 3 c.t.'s)	
326	Same as Code 325. Use order code 325.		526	0-1-2-3 (45° Step Switch)		876	1-2-3-4 (90° Ammeter Switch — 4 c.t.'s)	
350	1-0-2 (Reversing 45° Changeover with O)		527	0-1-2-3-4 (45° Step Switch)		877	0-1 (90° Ammeter Switch — 1 c.t.)	
375	1-0-2 (90° Changeover with O)		528	0-1-2-3-4-5 (45° Step Switch)				
425	1-2-3 (45° Step Switch)		550	0-1-2 (60° Step Switch)				

Bulletin 194L  
**IEC Control and Load Switches**  
 Switching Diagrams

Circuit Diagram Nos. 1501...4253

Contact target tables: X = Contact Closed  
 [Blank] = Contact Open

2

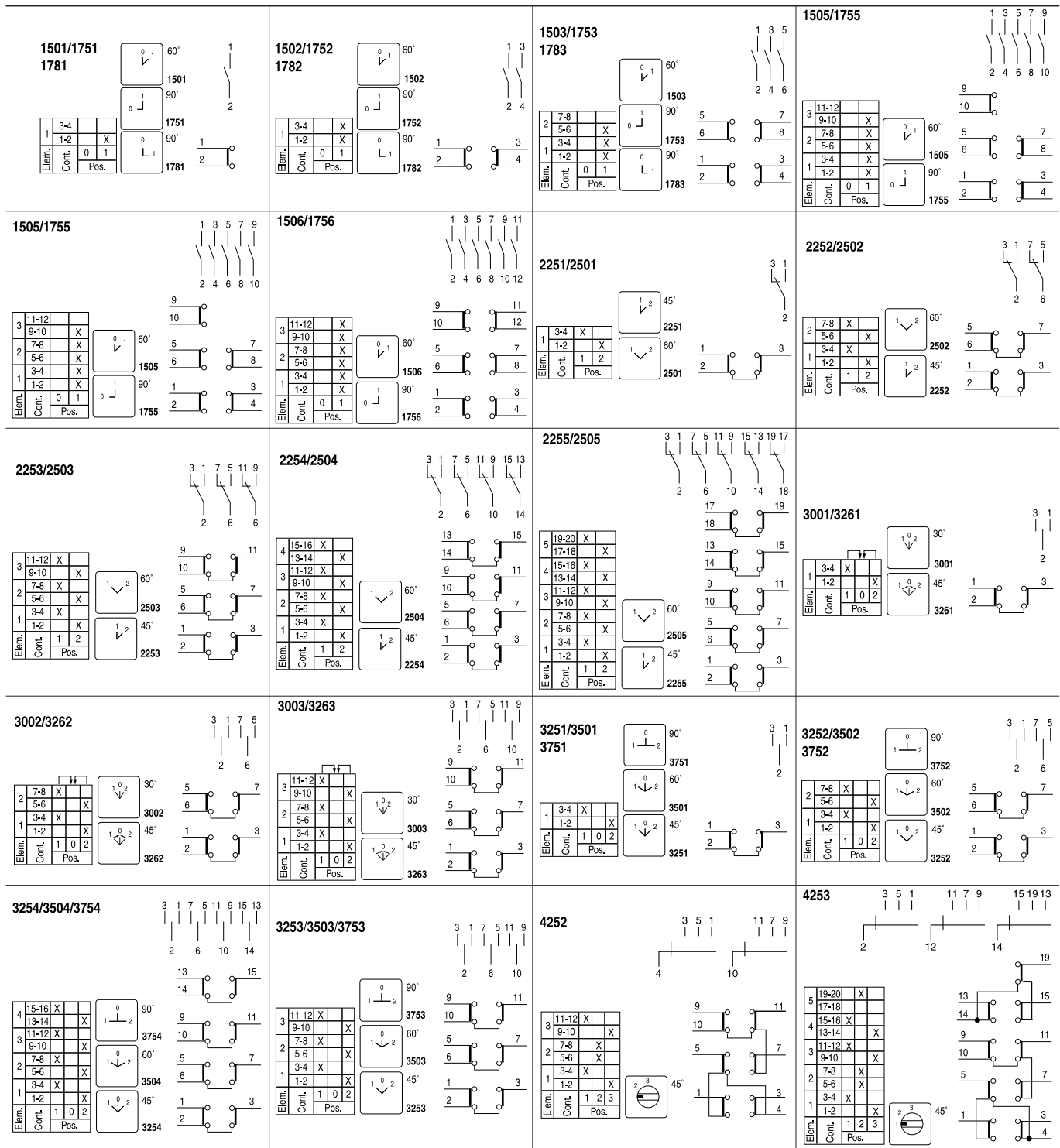

Circuit Diagram Nos. 4271...5531

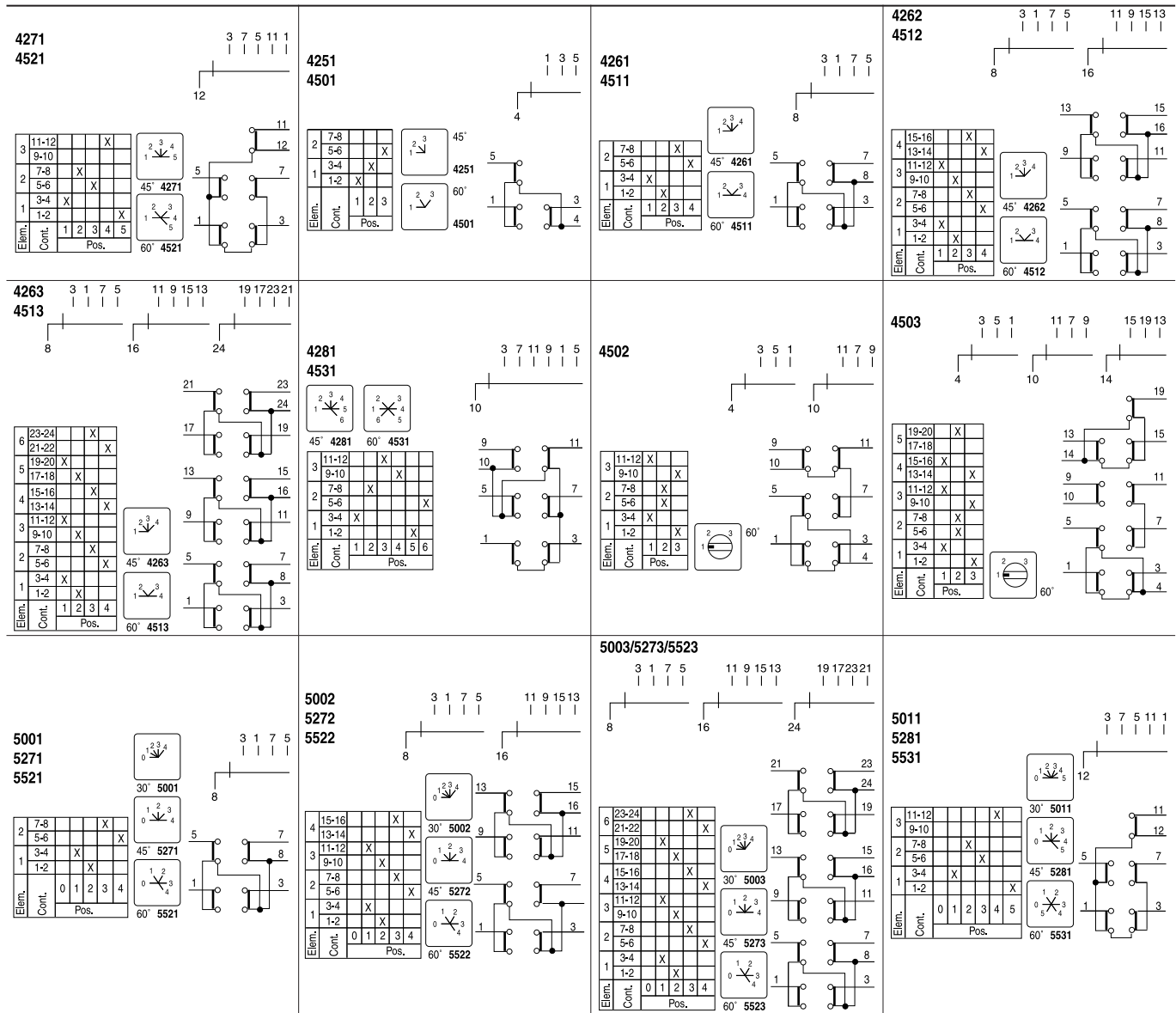

Circuit Diagram Nos. 5012...5272

2

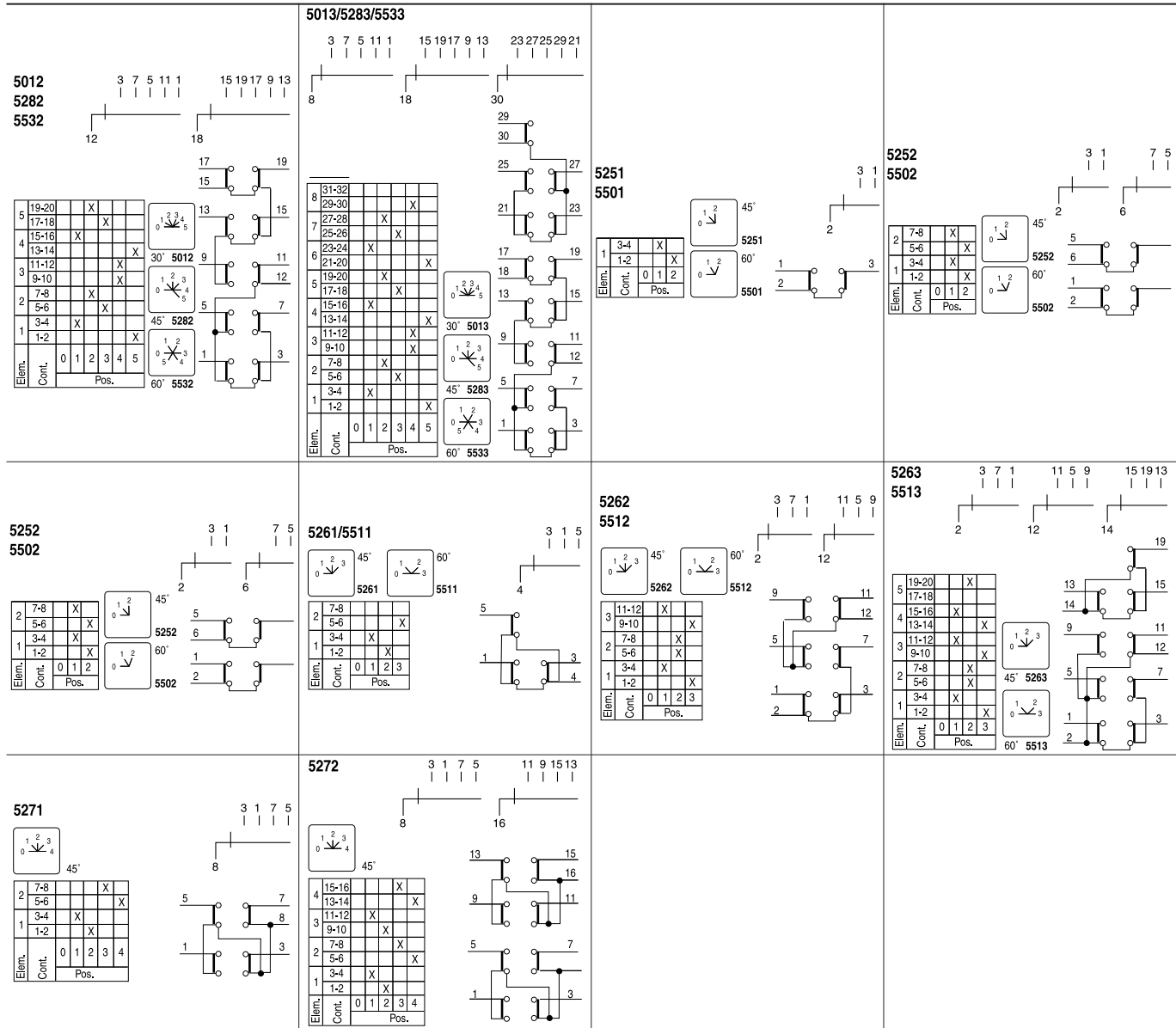

Circuit Diagram Nos. 5273...8771

**5273**

6	23-24			X
5	21-22	X		X
5	19-20	X		
4	15-16		X	X
4	13-14		X	
3	11-12	X		
3	9-10		X	
2	7-8			X
2	5-6			X
1	3-4	X		
1	1-2		X	

**7253**  
**7323**  
**7503**

4	15-16	X	X
3	13-14	X	X
3	11-12		
2	9-10	X	
2	7-8	X	
2	5-6	X	
1	3-4	X	X
1	1-2	X	X

**7303**  
**7543**

3	11-12	X	X
2	9-10		
2	7-8	X	
1	5-6	X	
1	3-4	X	
1	1-2		X

**8251**

3	11-12	X			
2	9-10	X	X	X	
2	7-8	X	X		
1	5-6			X	X
1	3-4	X	X		
1	1-2	X	X		X

**8271**

2	7-8	X	X
1	5-6	X	X
1	3-4	X	X
1	1-2		X

**8751**

3	11-12		X	X
2	9-10		X	X
2	7-8		X	X
1	5-6	X	X	
1	3-4	X	X	X
1	1-2	X	X	

**8761**

4	15-16		X	X
3	13-14	X		X
3	11-12			X
2	9-10	X	X	
2	7-8	X	X	
1	5-6	X	X	X
1	3-4	X	X	X
1	1-2	X	X	X

**8771**

1	3-4	X	X
1	1-2	X	X





Bulletin 194L  
**IEC Control and Load Switches**  
 Specifications

**Electrical Ratings**

Performance Data						12 A	16 A	20 A	25 A	32 A	40 A				
<b>IEC Applications</b>															
Rated voltage $U_e$ *		IEC-947	[V]	690	690	690	690	690	690	690	690				
Isolating conditions acc. to VDE fulfilled up to rated impulse voltage $U_{imp}$			[kV]	6	6	6	6	8	8						
Thermal rated current $I_{th}$ * 40 °C		IEC-947	[A]	16	20	25	30	32	45						
Thermal rated current $I_{the}$ 60 °C		IEC-947	[A]	12	16	20	25	32	45						
Rated current $I_e$ *															
AC-1/ AC-21A	Non-inductive or slightly inductive loads/ switching of resistive loads with slight overload	IEC-947	690V [A]	12	16	20	25	32	40						
AC-1	Non-inductive or slightly inductive loads	SEV	660V [A]	12	16	20	25	32	40						
AC22A	Switching of mixed resistive and inductive loads with slight overload	IEC-947	220...500V [A]	12	16	20	25	32	40						
			690V [A]	12	16	20	25	32	40						
AC-15	Switching of inductive drives, motors, valves, and electromagnets.	IEC-947	220...240V [A]	5	6	7	8	—	—						
			380...415V [A]	3	4	5	6	—	—						
			500V [A]	2	2.5	3	4	—	—						
DC switching capacity															
Rated current $I_e$															
Rated Voltage [V]		Contacts in series													
		1	2	3	4	5	6	8							
		24	48	72	96	120	144	192	[A]	12	16	20	22	—	—
		48	96	144	192	240	288	384	[A]	10	12	16	18	—	—
		60	120	180	240	300	360	450	[A]	8	10	12	14	32	40
DC-21A	For resistive loads, $T \leq 1$ ms	110	220	330	440	550	660	—	[A]	2	2.5	4	5	—	—
		220	440	660	—	—	—	—	[A]	0.5	0.6	0.7	0.8	—	—
$U_e$ max = 600V		440	—	—	—	—	—	—	[A]	0.4	0.4	0.5	0.5	—	—
Rated making/breaking capacity (= 1.5 x $I_e$ )															
		25.2	50.4	75.6	100.8	126	151.2	201.6	[A]	18	24	30	33	—	—
1.05 x Rated voltage [V]		50.4	100.8	151.2	201.6	252	302.4	403.2	[A]	15	21	24	27	—	—
For resistive loads, $T I_{th} 1$ ms		63	126	189	252	315	378	504	[A]	12	18	18	21	48	60
		115.5	231	346.5	462	577.5	—	—	[A]	3	4.5	6	7.5	—	—
$U_e$ max = 600V		231	462	—	—	—	—	—	[A]	0.75	1.12	1.05	1.2	—	—
		462	—	—	—	—	—	—	[A]	0.52	0.78	0.47	0.75	—	—
Rated current $I_e$															
Rated voltage [V]		24	48	72	96	120	144	192	[A]	8	10	12	14	16	16
		30	60	90	120	150	180	240	[A]	4.5	5.5	7	8	—	—
For inductive loads $T = 50$ ms		48	96	144	192	240	288	384	[A]	1.5	2	2.5	3	8	8
Rated voltage [V]		60	120	180	240	300	360	450	[A]	1	1.2	1.5	1.8	4.8	4.8
		110	220	330	440	550	660	—	[A]	0.4	0.5	0.6	0.7	2	2
		220	—	—	—	—	—	—	[A]	—	—	—	—	0.6	0.6
Rated making/breaking capacity (= 1.1 x $I_e$ )															
1.1 x Rated voltage [V]		26.4	52.8	79.2	105.6	132	158.4	184.8	[A]	8.8	11	13.2	1.54	—	17.6
		33	66	99	132	165	198	231	[A]	4.95	6.05	7.7	8.8	—	—
For inductive loads $T = 50$ ms		52.8	105.6	158.4	211.2	264	316.8	369.6	[A]	1.65	2.2	2.75	3.3	8.8	8.8
$U_e$ max = 600V		66	132	198	264	330	396	462	[A]	1.1	1.32	1.65	1.98	5.28	5.28
		121	242	363	484	605	—	—	[A]	4.95	6.05	7.7	8.8	2.2	2.2
Power Lost															
									[W]	0.3	0.5	0.6	0.9	0.8	1.4
Rated power															
$P_e$															
		Contacts in series													
		24			1				[kW]	0.12	0.15	0.20	0.25	0.30	0.30
		24			2				[kW]	0.20	0.25	0.30	0.37	—	—
		48			2				[kW]	0.25	0.30	0.37	0.50	0.50	0.50
		48			3				[kW]	0.30	0.37	0.50	0.75	—	—
Rated voltage [V]		60			2				[kW]	0.25	0.30	0.37	0.50	1.00	1.00
DC-23A, DC-3, DC-5		60			4				[kW]	0.37	0.50	0.75	1.00	—	—
For inductive loads, $T \leq 1$ ms		110			4				[kW]	0.50	0.75	1.00	1.20	—	—
		110			6				[kW]	1.00	1.20	1.40	1.60	—	—
		220			4				[kW]	0.37	0.50	0.75	1.00	—	—
		220			6				[kW]	1.00	1.20	1.40	1.50	—	—

\* See standards compliance listed on page page 2-428.

\* 32 and 40 A data for one contact in series.



**Electrical Ratings**

Performance Data, Continued				12 A	16 A	20 A	25 A	32 A	40 A
<b>IEC Applications, Continued</b>									
Rated making/breaking capacity (= 4 x I <sub>e</sub> )				Contacts in series					
	Rated Voltage [V]								
DC-23A, DC-3, DC-5 For inductive loads, T ≤ 7.5 ms	25.2	1	[A]	20.0	25.0	33.3	41.6	50.0	50.0
	25.2	2	[A]	33.3	41.6	50.0	61.6	—	—
	50.4	2	[A]	21.0	25.0	30.8	41.6	41.6	41.6
	50.4	3	[A]	25.0	30.8	42.0	62.4	—	—
	63	2	[A]	16.6	20.0	24.6	33.2	66.6	66.6
	63	4	[A]	24.6	33.3	50.0	66.4	—	—
	115.5	4	[A]	18.1	27.2	36.4	44.0	—	—
	115.5	6	[A]	36.4	43.6	51.0	58.2	—	—
	231	4	[A]	6.7	9.1	13.6	18.2	—	—
	231	6	[A]	18.1	21.8	25.2	27.2	—	—
Rated breaking capacity		at 220V	[A]	72	96	128	176	296	296
		0.45 [cos φ]							
		at 380V	[A]	72	96	128	176	280	336
Rated power P <sub>e</sub> *		0.45 [cos φ]							
		at 660V	[A]	53	72	86	112	196	196
		0.45[cos φ]							
AC-2	Slip-ring motors: starting, reversing and electric braking; star/delta starting	IEC-947							
		3 Ø	240V [kW]	3	4	5.5	5.5	—	—
			380V [kW]	5.5	7.5	9	13	—	—
			415V [kW]	5.5	7.5	9	13	—	—
			440V [kW]	5.5	7.5	9	13	—	—
			500V [kW]	7.5	10	11	15	—	—
	660V [kW]	7.5	10	11	15	—	—		
AC-3	Squirrel-cage motors: starting and stopping of running motors	IEC-947							
		3 Ø	220...240V [kW]	2.2	3	4.5	5.5	7.5	7.5
			380...440V [kW]	4	5.5	7.5	11	15	18.5
			500V [kW]	5.5	7.5	10	13	—	—
			660V [kW]	5.5	7.5	8	11	18.5	18.5
		1 Ø	110V [kW]	0.75	1.1	1.2	1.6	—	—
2-pole	220...240V [kW]	1.3	2.2	2.5	3.2	4	4		
	380...440V [kW]	2.2	3.7	4.5	5.5	8	16		
AC-4	Squirrel-cage motors: starting, reversing, electric braking, inching	IEC-947							
		3 Ø	220...240V [kW]	0.75	1.5	3	4	5.5	5.5
			380...415V [kW]	1.5	2.2	3.7	5.5	7.5	7.5
			440...550V [kW]	1.5	2.2	3.7	5.5	7.5	11
		1 Ø	110V [kW]	0.18	0.37	0.55	0.75	—	—
		2-pole	240V [kW]	0.37	0.75	1.5	2.2	—	—
	380V [kW]	0.75	1.1	1.8	3	—	—		
	440V [kW]	0.75	1.1	1.8	3	—	—		

\* See standards compliance listed on page 2-428.

Bulletin 194L  
**IEC Control and Load Switches**  
 Specifications

**Electrical Ratings**

Performance Data, Continued					12 A	16 A	20 A	25 A	32 A	40 A
<b>IEC Applications, Continued</b>										
AC-23A	Occasional switching of motors and other highly inductive loads (criterion for selecting main switches)	IEC-947	220...240V	[kW]	2.2	3	4.5	5.5	11	11
		3Ø	380...440V	[kW]	4	5.5	7.5	11	18.5	22
		3-pole	500V	[kW]	5.5	7.5	10	13	—	—
			660V	[kW]	5.5	7.5	8	11	22	22
1Ø	110V	[kW]	0.75	1.1	1.2	1.6	—	—		
2-pole	220...240V	[kW]	1.3	2.2	2.5	3.2	5.5	5.5		
		380...440V	[kW]	2.2	3.7	4.5	5.5	11	11	
Short-circuit ratings		(gL characteristic)	[kA <sub>rms</sub> ]	[A]	0.48	0.48	0.6	0.75	0.8	0.8
Rated short-time current (1s)					20*	20*	20*	25*	35	40
Strongest series fuse, not in enclosure					6	6	5	5	5	5
Conditional rated short-circuit			[kA]							
Switch Rate		electrical		[ops/h]	120	120	120	120	120	120
<b>CSA and UL Applications</b>										
Rated Voltage $U_e$			[V AC]		600	600	600	600	600	600
Ampere Rating	Pilot Duty	Contact class		[A]	A600	A600	—	—	—	—
	General Use	Non-inductive or slightly inductive load*			12	16	20	25	32	40
Rated power $P_e$ †		UL (CSA)		(FLA)	(FLA)	(FLA)	(FLA)			
Standard motor DOL rating (similar to AC-3)	3Ø	120V	[Hp]	1 (7.2)	1.5 (12)	2 (13.6)	3 (19.2)	5 (30.4)	5 (30.4)	
		240V	[Hp]	2 (6.8)	3 (9.6)	4 (12.4)	6 (18)	7.5 (22)	10 (28)	
		480V	[Hp]	5 (7.6)	7.5 (11)	8 (11.6)	12 (17)	20 (27)	25 (34)	
		600V	[Hp]	5 (6.1)	7.5 (9)	10 (11)	15 (17)	20 (22)	25 (27)	
	1Ø	120V	[Hp]	0.5 (9.8)	.75 (13.8)	1 (16)	1.5 (20)	2 (24)	2 (24)	
		240V	[Hp]	1 (8.0)	1.5 (10.0)	2 (12)	3 (17)	5 (28)	5 (28)	
		480V	[Hp]	2 (6.0)	3 (8.5)	4 (11.2)	6 (17)	7.5 (21)	10 (26)	
		600V	[Hp]	3 (6.8)	3 (6.8)	5 (11.2)	7.5 (16)	10 (20)	15 (27)	
Heavy motor load, reversing Rating (similar to AC-4)		3Ø	120V	[Hp]	—	—	—	—	—	
Max. back-up fuse		3-pole	240V	[Hp]	—	—	—	—	—	
		(gG characteristic)		[A]	35	55	60	80		
Short Circuit Ratings	Maximum Short Circuit Prospective Fault Current			[kA]	5	5	5	5		
	Maximum Fuse Size			[A]	35	55	60	80		
Switching Rate		electrical		[ops/h]	120	120	120	120	120	120

**Mechanical Data**

Performance Data				12/16 A	20/25 A	32/40 A
Protection class acc. to IEC 529	Handles Switch Bodies			IP66 IP20	IP66 IP20	IP66 IP20
Mechanical Endurance		[mil.ops]	1	1	1	
Switching rate	mechanical	[ops/h]	1200	1200	1200	
Maximum Wire Gauges						
	rigid wire	AWG	(2)18...12	(2)16...10	(2)12...8	
		[mm <sup>2</sup> ]	(2)1...2.5	(2)1.5...6	(2)4...10	
	fine strands	AWG	(2)18...12	(2)16...10	(2)14...10	
		[mm <sup>2</sup> ]	(2)1...2.5	(2)1.5...4	(2)2.5...6	

**Environmental Data**

Performance Data		12/16/20/25 A	32/40 A
Ambient temperature			
Operation		-25...+60 °C (-13...+140 °F)	-25...+60 °C (-13...+140 °F)
	Storage	-40...+80 °C (-40...+176 °F)	-40...+80 °C (-40...+176 °F)

\* Does not apply to switches in enclosure.

‡ Suitable for switching off-load (AC-20) above 660V, but only up to 660V for switches with screws at the rear.

† See standards compliance listed on page 2-434.



Dimensions are shown in millimeters (inches). Dimensions are not intended to be used for manufacturing purposes.

**Cat. No. 194L-C... for Central Fixing (194L-HC...)**

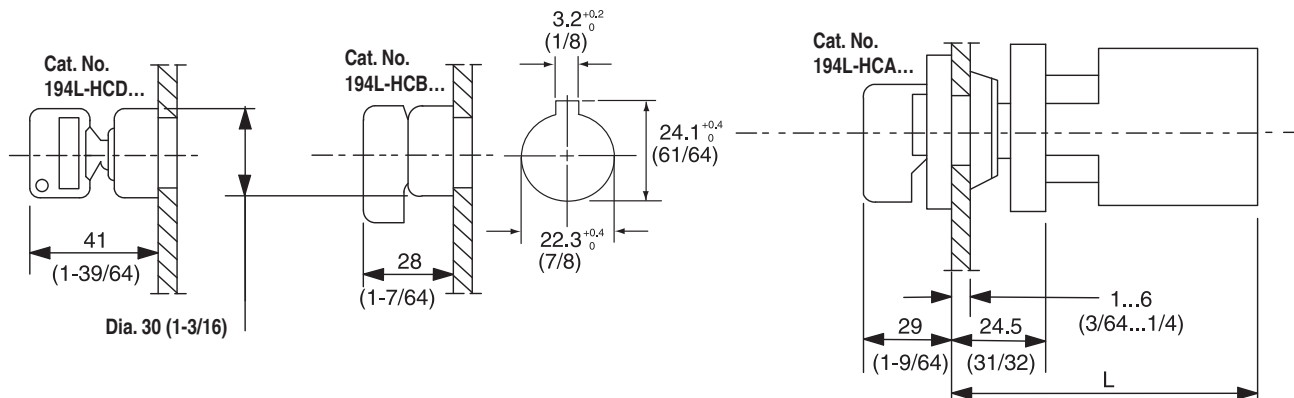

Cat. No.	L				
	No. of Contacts				
	1...2	3...4	5...6	7...8	9...10
194L-C32/40...	86 (3-25/64)	103.5 (4-5/64)	121 (4-49/64)	138.5 (5-29/64)	156 (6-9/64)

**Cat. No. 194L... for Front (Door) Installation**

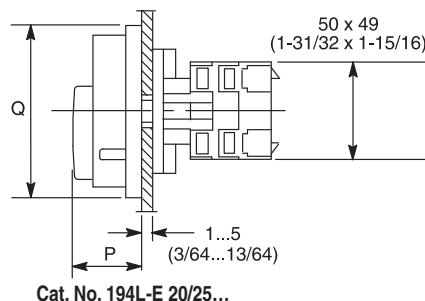
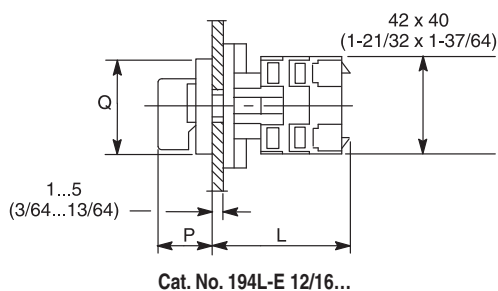

**Mounting Dimensions**

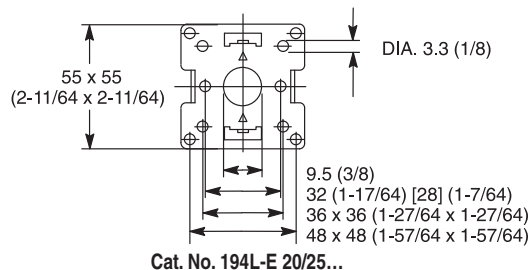
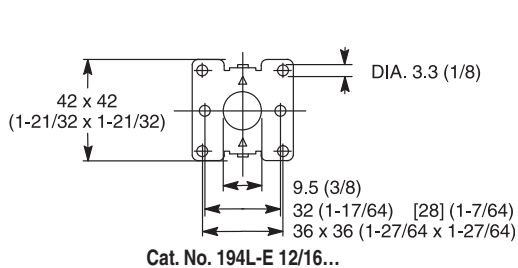

Cat. No.	L				
	No. of Contacts				
	1...2	3...4	5...6	7...8	9...10
194L-E12/16...	44 (1-47/64)	54 (2-1/8)	64 (2-33/64)	74 (2-29/32)	84 (3-5/16)
194L-E20/25...	44.5 (1-3/4)	57 (2-1/4)	69.5 (2-3/4)	82 (3-15/64)	94.5 (3-23/32)
194L-E32/40...	43 (1-11/16)	58.5 (2-5/16)	76 (2-63/64)	93.5 (3-11/16)	111 (4-3/8)

Bulletin 194L  
**IEC Control and Load Switches**  
 Approximate Dimensions

Dimensions are shown in millimeters (inches). Dimensions are not intended to be used for manufacturing purposes.

**Control Knob**

Cat. No.	P	Q
194L-HE4A...	28 (1-7/64)	48 (1-57/64) x 48 (1-57/64)
194L-HE4L...		48 (1-57/64) x 62 (2-7/16)
194L-HE4S...		64 (2-33/64) x 64 (2-33/64)
194L-HE6A...		64 (2-33/64) x 78 (3-5/64)
194L-HE6L...		67 (2-41/64) x 67 (2-41/64)
194L-HE6N...		
194L-HE6G...		34 (1-11/32)

**Cat. No. 194L-A... for Base/DIN Rail Installation**

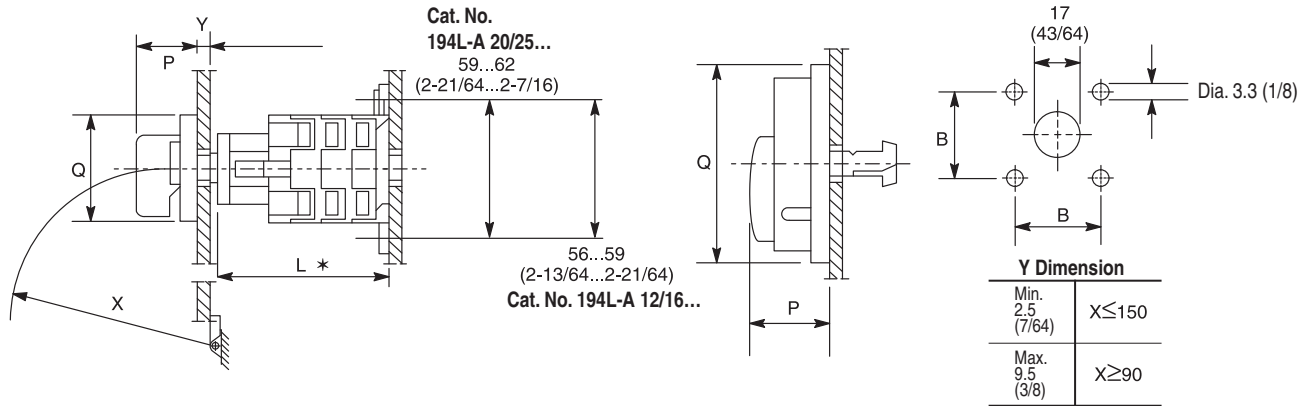

Cat. No.	L *			
	No. of Contacts			
	1...2	3...4	5...6	7...8
194L-A12/16...	58 (2-9/32)	68 (2-11/16)	78 (3-5/64)	88 (3-15/32)
194L-A20/25...	58 (2-9/32)	71.5 (2-13/16)	84 (3-5/16)	96.5 (3-51/64)
194L-A32/40...	67.5 (2-21/32)	85 (3-11/32)	102.5 (4-1/32)	120 (4-47/64)

**Control Knob**

Cat. No.	P	B	Q	
194L-HE4A...	28 (1-7/64)	36 (1-27/64)	48 (1-57/64) x 48 (1-57/64)	
194L-HE4L...			48 (1-57/64) x 62 (2-7/16)	
194L-HE4S...		48 (1-57/64)	64 (2-33/64) x 64 (2-33/64)	
194L-HE6A...			64 (2-33/64) x 78 (3-5/64)	
194L-HE6L...			67 (2-41/64) x 67 (2-41/64)	
194L-HE6S...		34 (1-11/32)		
194L-HE6N...				
194L-HE6G...				

\* With DIN 46 277 (35) Rail + 2.5 mm (7/64)

Dimensions are shown in millimeters (inches). Dimensions are not intended to be used for manufacturing purposes.

**Cat. No. 194L-A... With Shaft Extension Cat. No. 194L-G2853**

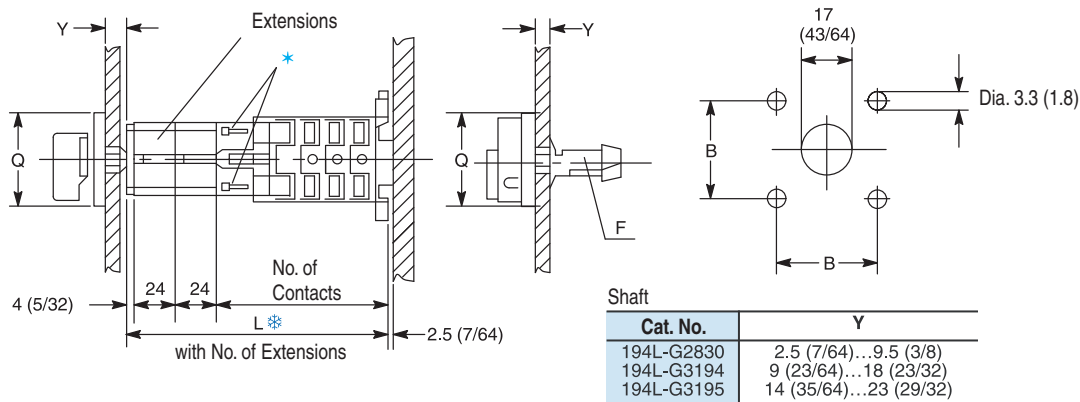

No. of Extensions	Cat. No. 194L-A12/16... 10mm (0.39)				Cat. No. 194L-A20/25... 12.5mm (0.49)				Cat. No. 194L-A32/40			
	L											
	No. of Contacts											
	1...2	3...4	5...6	7...8	1...2	3...4	5...6	7...8	1...2	3...4	5...6	7...8
With 1 extension	82 (3-15/64)	92 (3-5/8)	102 (4-1/64)	112 (4-13/32)	83 (3-17/64)	95.5 (3-49/64)	108 (4-1/4)	120.5 (4-3/4)	91.5 (3-15/64)	108 (4-1/4)	126.5 (5-63/64)	144 (6-43/64)
With 2 extensions	106 (4-11/64)	116 (4-37/64)	126 (4-31/32)	136 (5-23/64)	107 (4-7/32)	119.5 (4-45/64)	132 (5-13/64)	144.5 (5-11/16)	115.5 (5-35/64)	133 (5-15/64)	150.5 (6-5/16)	168 (7-5/8)
With 3 extensions	130 (5-1/8)	140 (5-33/64)	150 (5-29/32)	160 (6-19/64)	131 (5-5/32)	143.5 (5-21/32)	156 (6-9/64)	168.5 (6-5/8)	135.5 (5-11/32)	157 (6-3/16)	174.5 (7-7/8)	182 (8-9/16)
With 4 * extensions	154 (6-1/16)	164 (6-15/32)	174 (6-55/64)	184 (7-15/64)	155 (6-7/64)	167.5 (6-19/32)	180 (7-3/32)	192.5 (7-37/64)	163.5 (6-7/16)	181 (7-1/8)	198.5 (8-53/64)	216 (9-33/64)
With 5 * extensions	178 (7-1/64)	188 (7-13/32)	198 (7-51/64)	208 (8-3/16)	179 (7-3/64)	191.5 (7-35/64)	204 (8-1/32)	216.5 (8-33/64)	187.5 (7-3/8)	205 (8-5/64)	222.5 (9-49/64)	240 (9-29/64)
With 6 * extensions	202 (7-61/64)	212 (8-23/64)	222 (8-3/4)	232 (9-1/8)	203 (7-63/64)	215.5 (8-31/64)	228 (8-63/64)	240.5 (9-15/32)	211.5 (8-21/64)	229 (12)	246.5 (10-23/32)	264 (10-13/32)

**Control Knob**

Cat. No.	Q	B
194L-HE4A...	48 (1-57/64) x 48 (1-57/64)	36 (1-27/64)
194L-HE4I...		
194L-HE6A...	64 (2-33/64) x 64 (2-33/64)	48 (1-57/64)
194L-HE6I...		
194L-HE6N...		
194L-HE6G...		

\* When more than 4 modules are used, attach the first one to the switch body using the screws supplied with the extension (Cat. No. 194L-G2853).  
 \* Mounting on DIN 46 277 (35) Rails.

Bulletin 194L  
**IEC Control and Load Switches**  
 Approximate Dimensions

Dimensions are shown in millimeters (inches). Dimensions are not intended to be used for manufacturing purposes.

**Cat. No. 194L-A... With Metal Shafts**

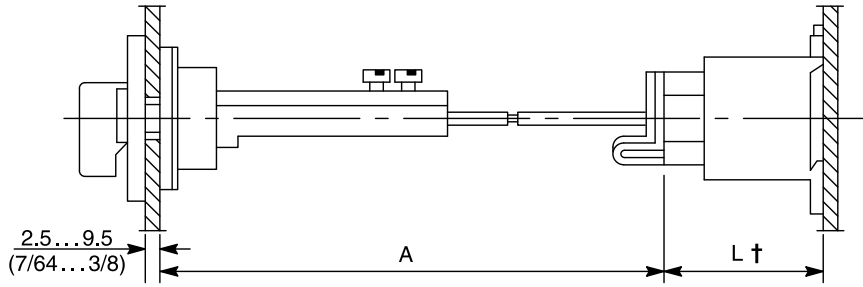

Cat. No.	A
194L-G3393...	110 (4-21/64)...235(9-1/4)
194L-G3394...	230 (9-1/16)...350 (13-25/32)

2

Cat. No.	L*			
	No. of Contacts			
	1...2	3...4	5...6	7...8
194L-A12/16...	54 (2-1/8)	64 (2-33/64)	74 (2-29/32)	84 (3-5/16)
194L-A20/25...	55 (2-11/64)	67.5 (2-21/32)	80 (3-5/32)	92.5 (3-41/64)
194L-A32/40...	63.5 (2-31/64)	81 (3-3/16)	88.5 (3-7/8)	116 (4-9/16)

**Modular Shaft Extensions (Cat. No. 194L-G2853)**

Select No. of Extension Modules and Shaft for use with enclosures.

No. of Extension Modules	Required End Shaft	Enclosure Mounting Depth‡	
		Cat. No. 194L-A12/16...	Cat. No. 194L-A20/25...
0	44 (1-47/64) §	71.5...77.5 (2-13/16...3-1/16)	75...80.5 (2-61/64...3-11/64)
	52 (2-3/64)	77...87 (3-1/32...3-27/64)	80...90 (3-5/32...3-35/64)
	57 (2-1/4)	82...92 (3-15/64...3-5/8)	85...95 (3-11/32...3-3/4)
1	44 (1-47/64) §	95.5...101.5 (3-49/64...4)	99...105 (3-29/32...4-9/64)
	52 (2-3/64)	97.5...111 (3-27/32...4-3/8)	101...114.5 (3-63/64...4-33/64)
	57 (2-1/4)	102.5...116 (4-3/64...4-37/64)	106...119.5 (4-11/64...4-45/64)
2	44 (1-47/64) §	119.5...125.5 (4-45/64...4-61/64)	123...129 (4-27/32...5-5/64)
	52 (2-3/64)	121.5...135 (4-51/64...5-5/16)	125...138.5 (4-59/64...5-29/64)
	57 (2-1/4)	126.5...140 (4-63/64...5-33/64)	130...143.5 (5-1/8...5-21/32)
3	44 (1-47/64) §	143.5...149.5 (5-21/32...5-57/64)	147...153 (5-51/64...6-1/32)
	52 (2-3/64)	145.5...159 (5-47/64...6-17/64)	149...162.5 (5-7/8...6-13/32)
	57 (2-1/4)	150.5...164 (5-15/16...6-15/32)	154...167.5 (6-1/16...6-19/32)
4	44 (1-47/64) §	167.5...173.5 (6-19/32...6-27/32)	171...177 (6-47/64...6-31/32)
	52 (2-3/64)	169.5...183 (6-43/64...7-13/64)	173...186.5 (6-13/16...7-11/32)
	57 (2-1/4)	174.5...188 (6-7/8...7-13/32)	178...191.5 (7-1/64...7-35/64)
5	44 (1-47/64) §	191.5...197.5 (7-35/64...7-25/32)	195...201 (7-43/64...7-59/64)
	52 (2-3/64)	193.5...207 (7-5/8...8-5/32)	197...210.5 (7-49/64...8-19/64)
	57 (2-1/4)	198.5...212 (7-53/64...8-23/64)	202...215.5 (7-61/64...8-31/64)
6	44 (1-47/64) §	215.5...221.5 (8-31/64...8-23/32)	219...225 (8-5/8...8-55/64)
	52 (2-3/64)	217.5...231 (8-37/64...9-3/32)	221...234.5 (8-45/64...9-15/64)
	57 (2-1/4)	222.5...236 (8-49/64...9-19/64)	226...239.5 (8-29/32...9-7/16)

\* When more than 4 modules are used, attach the first one to the switch body using the screws supplied with the extension (**Cat. No. 194L-G2853**).

‡ With DIN 46 277 (35) Rail + 2.5 mm (7/64)

† For DIN Rail-mounted devices, remember to deduct the offset distance provided by the rail. For example, deduct 2.5 mm (7/64 in.) from the mounting depth for Bulletin 194L switch body mounted on DIN 46277 rail.

§ One 44 mm (1-47/64 in) end shaft is supplied with all Bulletin 194L Switch Bodies.

Dimensions are shown in millimeters (inches). Dimensions are not intended to be used for manufacturing purposes.

Cat. No. 194L-A... With Cat. No. 194L-HE4P-... Installation on DIN 46277 (35 mm) Rails + 2.5 mm (7/64 in.)	Cat. No.	L			
		No. of Contacts			
		1...2	3...4	5...6	7...8
	194L-A12/16...	35 (1-3/8)	45 (1-49/64)	55 (2-11/64)	65 (2-9/16)
	194L-A20/25...	33.5 (1-21/64)	48 (1-57/64)	60.5 (2-3/8)	73 (2-7/8)
	194L-A32/40...	43 (1-11/16)	61 (2-13/32)	79 (3-7/64)	97 (3-53/64)

2

Cat. No. 194L-E... With Terminal Cover	Cat. No.	A	B	C	D
	194L-E12/16...	40 (1-37/64)	42.5 (1-43/64)	12 (15/32)	2.5 (7/64)
	194L-E20/25...	49 (1-15/16)	37.5 (1-31/64)	12 (15/32)	2.5 (7/64)
	194L-E32/40...	59 (2-21/64)	50 (1-31/32)	15 (19/32)	2.5 (7/64)

Cat. No. 194L-A... With Terminal Cover	Cat. No.	A	B	C	D
	194L-A12/16...	40 (1-37/64)	42.5 (1-43/64)	12 (15/32)	2.5 (7/64)
	194L-A20/25...	49 (1-15/16)	37.5 (1-31/64)	12 (15/32)	2.5 (7/64)
	194L-A32/40...	63.5 (2-1/2)	49 (1-53/64)	12 (15/32)	2 (5/64)

**Enclosure**

**Cat. No. 194L-G3572...Cat. No. 194L-G3579**

