

Application Manual



August 2010

Important Notice — Please Read

The product discussed in this literature is subject to terms and conditions outlined in Eaton Electrical Inc. selling policies. The sole source governing the rights and remedies of any purchaser of this equipment is the relevant Eaton Electrical Inc. selling policy.

NO WARRANTIES, EXPRESS OR IMPLIED, INCLUDING WARRANTIES OF FITNESS FOR A PARTICULAR PURPOSE OR MERCHANTABILITY, OR WARRANTIES ARISING FROM COURSE OF DEALING OR USAGE OF TRADE, ARE MADE REGARDING THE INFORMATION, RECOMMENDATIONS AND DESCRIPTIONS CONTAINED HEREIN. In no event will Eaton Electrical Inc. be responsible to the purchaser or user in contract, in tort (including negligence), strict liability or otherwise for any special, indirect, incidental or consequential damage or loss whatsoever, including but not limited to damage or loss of use of equipment, plant or power system, cost of capital, loss of power, additional expenses in the use of existing power facilities, or claims against the purchaser or user by its customers resulting from the use of the information, recommendations and descriptions contained herein.

The information contained in this manual is subject to change without notice.

Cover Photo: Eaton's Series 9000X AF Drives.

Table of Contents

CHAPTER — LIST OF FIGURES	iv
CHAPTER — LIST OF TABLES	v
CHAPTER — SAFETY	viii
Definitions and Symbols	viii
Hazardous High Voltage	viii
Cautions and Notices	ix
CHAPTER 1 — BASIC APPLICATION	1-1
Introduction	1-1
Control I/O	1-2
Basic Application — Parameter Lists	1-3
CHAPTER 2 — STANDARD APPLICATION	2-1
Introduction	2-1
Control I/O	2-2
Standard Application — Parameter Lists	2-3
CHAPTER 3 — LOCAL/REMOTE CONTROL APPLICATION	3-1
Introduction	3-1
Control I/O	3-2
Local/Remote Control Application — Parameter Lists	3-3
CHAPTER 4 — MULTI-STEP SPEED CONTROL APPLICATION	4-1
Introduction	4-1
Control I/O	4-2
Multi-Step Speed Control Application — Parameter Lists	4-3
CHAPTER 5 — PID CONTROL APPLICATION	5-1
Introduction	5-1
Control I/O	5-2
PID Control Application — Parameter Lists	5-3
CHAPTER 6 — MULTI-PURPOSE CONTROL APPLICATION	6-1
Introduction	6-1
Control I/O	6-2
“Terminal To Function” (TTF) Programming Principle	6-3
Parameter Lists	6-5
Fieldbus Control and Status	6-7
Input Signals	6-9
Output Signals	6-14
CHAPTER 7 — PUMP AND FAN CONTROL APPLICATION	7-1
Introduction	7-1
Control I/O	7-2
Short Description of Function and Essential Parameters	7-5
Parameter Lists	7-10
Input Signals	7-13
Output Signals	7-17

August 2010

Table of Contents, continued

CHAPTER 8 — DESCRIPTION OF PARAMETERS	8-1
Introduction	8-1
Keypad Control Parameters	8-86
APPENDIX A — ADDITIONAL INFORMATION	A-1
External Brake Control with Additional Limits	A-1
Closed Loop Parameters	A-3
Parameters of Motor Thermal Protection	A-4
Parameters of Stall Protection	A-4
Parameters of Underload Protection	A-5
Fieldbus Control Parameters	A-5

List of Figures

Defining Input/Output — Function	6-3
Defining Input/Output — Values	6-3
Screenshot of 9000X Drive Programming Tool; Entering the Address Code	6-4
2-Pump Autochange System Principal Control Diagram	7-3
3-Pump Autochange System Principal Control Diagram	7-4
Example of the Function of the PFC Application with Three Aux. Drives	7-8
Example of 2-Pump Autochange, Main Diagram	7-9
Example of 3-Pump Autochange, Main Diagram	7-9
Linear and Squared Change of Motor Voltage	8-2
Programmable V/Hz Curve	8-3
PID Controller Function as I-Controller	8-6
PID Output Curve with the Values of Example 2	8-6
PID Output Curve with the Values of Example 3	8-7
Start Forward/Start Reverse	8-11
Start, Stop and Reverse	8-11
Start Pulse/Stop Pulse	8-12
DIN3 as DC-Brake Command Input	8-15
With and Without Reference Scaling	8-15
Reference Inversion	8-16
Reference Filtering	8-16
Analog Output Filtering	8-17
Analog Output Invert	8-17
Analog Output Scaling	8-18
Output Frequency Supervision	8-20
DC Braking Command (Selection 12) Selected for DIN2	8-22
AI1 No Signal Inversion	8-23
AI1 Signal Inversion	8-23
AI1 Signal Filtering	8-24
Analog Input AI2 Scaling	8-24
Examples of Actual Value Signal Scaling	8-27
Control Place B with and without Reference Scaling	8-28
External Brake Control	8-30
An Example of On/Off-Control	8-31
Scaling of Max. Motor Current	8-32
Reduction of DC Braking Current	8-32
Reduction of Acceleration and Deceleration Times	8-33
Reduction of Torque Supervision Limit	8-33
Place B Start Forward/Start Reverse	8-34
Place B Start, Stop, Reverse	8-34
Place B Start Pulse/Stop Pulse	8-35
PID Sum Point Reference	8-37
An Example of Joystick Hysteresis	8-38
Example of Sleep Limit Function	8-39
Joystick Hysteresis with Minimum Frequency at 35 Hz	8-40
Scaling of DC-Braking Current	8-41

List of Figures, continued

Reducing Acceleration and Deceleration Times	8-42
Reducing Torque Supervision Limit	8-42
Digital Outputs 1 and 2, On- and Off-Delays	8-49
An Example of Adjust Input	8-50
Acceleration/Deceleration (S-shaped)	8-51
DC-Braking Time when Stop Mode = Coasting	8-53
DC-Braking Time when Stop Mode = Ramp	8-54
Example of Skip Frequency Area Setting	8-55
Ramp Speed Scaling between Skip Frequencies	8-56
Motor Thermal Current IT Curve	8-63
Motor Temperature Calculation	8-64
Stall Characteristics Settings	8-65
Stall Time Count	8-65
Setting of Minimum Load	8-66
Underload Time Counter Function	8-67
Example of Automatic Restarts with Two Restarts	8-68
Example of Parameter Setting	8-75
Reference Steps after Starting Auxiliary Drives	8-76
Frequency Converter Sleep Function	8-77
Example of Adjustable Frequency Drive and Two Auxiliary Drives with Bypassed PID Controller	8-79
Input and Output Pressure Measuring	8-80
Output Pressure Behavior Depending on Input Pressure and Parameter Settings	8-80
Frequency Drop and Increase Delays	8-81
Autochange Applied to Auxiliary Drives Only	8-82
Autochange with All Drives	8-82
Autochange Interval and Limits	8-83
Actual Value Special Display	8-84
Brake Control with Additional Limits	A-1
Brake Control Logic	A-2

List of Tables

Table 1-1: Basic Application Default I/O Configuration	1-2
Table 1-2: Monitoring Values	1-3
Table 1-3: Basic Parameters — G1	1-4
Table 1-4: Keypad Control Parameters — M2	1-5
Table 2-1: Standard Application Default I/O Configuration	2-2
Table 2-2: Monitoring Values	2-3
Table 2-3: Basic Parameters — G1.1	2-4
Table 2-4: Input Signals — G1.2	2-5
Table 2-5: Output Signals — G1.3	2-5
Table 2-6: Drive Control Parameters — G1.4	2-7
Table 2-7: Skip Frequency Parameters — G1.5	2-7
Table 2-8: Motor Control Parameters — G1.6	2-8
Table 2-9: Protections — G1.7	2-9
Table 2-10: Autorestart Parameters — G1.8	2-10
Table 2-11: Keypad Control Parameters — M2	2-11

List of Tables, continued

Table 3-1: Local/Remote Application Default I/O Configuration	3-2
Table 3-2: Monitoring Values	3-3
Table 3-3: Basic Parameters — G1.1	3-4
Table 3-4: Input Signals — G1.2	3-5
Table 3-5: Output Signals — G1.3	3-7
Table 3-6: Drive Control Parameters — G1.4	3-9
Table 3-7: Skip Frequency Parameters — G1.5	3-10
Table 3-8: Motor Control Parameters — G1.6	3-10
Table 3-9: Protections — G1.7	3-12
Table 3-10: Autorestart Parameters — G1.8	3-13
Table 3-11: Keypad Control Parameters — M2	3-14
Table 4-1: Multi-Step Speed Control Application Default I/O Configuration	4-2
Table 4-2: Monitoring Values	4-3
Table 4-3: Basic Parameters — G1.1	4-4
Table 4-4: Input Signals — G1.2	4-5
Table 4-5: Output Signals — G1.3	4-7
Table 4-6: Drive Control Parameters — G1.4	4-9
Table 4-7: Skip Frequency Parameters — G1.5	4-9
Table 4-8: Motor Control Parameters — G1.6	4-10
Table 4-9: Protections — G1.7	4-12
Table 4-10: Autorestart Parameters — G1.8	4-13
Table 4-11: Keypad Control Parameters — M2	4-13
Table 5-1: PID Application Default I/O Configuration (with 2-wire transmitter)	5-2
Table 5-2: Monitoring Values	5-3
Table 5-3: Basic Parameters — G1.1	5-4
Table 5-4: Input Signals — G1.2	5-6
Table 5-5: Output Signals — G1.3	5-9
Table 5-6: Drive Control Parameters — G1.4	5-11
Table 5-7: Skip Frequency Parameters — G1.5	5-11
Table 5-8: Motor Control Parameters — G1.6	5-12
Table 5-9: Protections — G1.7	5-14
Table 5-10: Autorestart Parameters — G1.8	5-15
Table 5-11: Keypad Control Parameters — M2	5-16
Table 6-1: Multi-Purpose Control Application Default I/O Configuration and Connection Example	6-2
Table 6-2: Monitoring Values, SPX Drives	6-5
Table 6-3: Operate Menu Items	6-6
Table 6-4: Fixed Control Word	6-7
Table 6-5: Status Word	6-7
Table 6-6: Basic Parameters — G1.1	6-8
Table 6-7: Input Signals: Basic Settings — G1.2.1	6-9
Table 6-8: Analog Input 1 Parameters — G1.2.2	6-10
Table 6-9: Analog Input 2 Parameters — G1.2.3	6-11
Table 6-10: Analog Input 3 Parameters — G1.2.4	6-11
Table 6-11: Analog Input 4 Parameters — G1.2.5	6-12
Table 6-12: Free Analog Input Signal Selection — G1.2.6	6-12
Table 6-13: Digital Input Signals — G1.2.7	6-13
Table 6-14: Delayed Digital Output 1 Parameters — G1.3.1	6-14
Table 6-15: Delayed Digital Output 2 Parameters — G1.3.2	6-14
Table 6-16: Digital Output Signals — G1.3.3	6-15
Table 6-17: Limit Settings — G1.3.4	6-16
Table 6-18: Analog Output 1 Parameters — G1.3.5	6-17
Table 6-19: Analog Output 2 Parameters — G1.3.6	6-18
Table 6-20: Analog Output 3 Parameters — G1.3.7	6-18

August 2010

List of Tables, continued

Table 6-21: Drive Control Parameters — G1.4	6-19
Table 6-22: Skip Frequency Parameters — G1.5	6-20
Table 6-23: Motor Control Parameters — G1.6	6-20
Table 6-24: Protections — G1.7	6-22
Table 6-25: Autorestart Parameters — G1.8	6-24
Table 6-26: Fieldbus Parameters — G1.9	6-24
Table 6-27: Torque Control Parameters — G1.10	6-25
Table 6-28: Keypad Control Parameters — M2	6-26
Table 7-1: Pump and Fan Control Application Default I/O Configuration and Connection Example (with 2-wire transmitter)	7-2
Table 7-2: Monitoring Values	7-10
Table 7-3: Basic Parameters — G1.1	7-11
Table 7-4: Input Signals, Basic Settings — G1.2.1	7-13
Table 7-5: Input Signals, Analog Input 1 — G1.2.2	7-14
Table 7-6: Input Signals, Analog Input 2 — G1.2.3	7-14
Table 7-7: Input Signals, Analog Input 3 — G1.2.4	7-15
Table 7-8: Input Signals, Analog Input 4 — G1.2.5	7-15
Table 7-9: Input Signals, Digital Inputs — G1.2.6	7-15
Table 7-10: Output Signals, Digital Outputs — G1.3.1	7-17
Table 7-11: Output Signals, Limit Settings — G1.3.2	7-18
Table 7-12: Output Signals, Analog Output 1 — G1.3.3	7-19
Table 7-13: Output Signals, Analog Output 2 — G1.3.4	7-20
Table 7-14: Output Signals, Analog Output 3 — G1.3.5	7-20
Table 7-15: Drive Control Parameters — G1.4	7-21
Table 7-16: Skip Frequencies — G1.5	7-22
Table 7-17: Motor Control Parameters — G1.6	7-22
Table 7-18: Protections — G1.7	7-23
Table 7-19: Autorestart Parameters — G1.8	7-24
Table 7-20: Pump and Fan Control Parameters — G1.9	7-25
Table 7-21: Keypad Control Parameters — M2	7-26
Table 8-1: Preset Speed	8-1
Table 8-2: Preset Speeds 3 to 7	8-5
Table 8-3: Multi-Step Speed Selections with Digital Inputs DIN3, DIN4, DIN5 and DIN6	8-7
Table 8-4: Selections for ID143	8-8
Table 8-5: Selections for ID171 and ID172	8-9
Table 8-6: Selections for ID173, ID174 and ID175	8-10
Table 8-7: Analog Output Scaling	8-18
Table 8-8: Output Signals Via DO1 and Output Relays RO1 and RO2	8-19
Table 8-9: Selections for ID320	8-22
Table 8-10: Selections for Parameter ID325	8-24
Table 8-11: Selections for ID332	8-25
Table 8-12: Size-Dependent Switching Frequencies	8-57
Table 8-13: Typical Monitored Items	8-73
Table 8-14: Selectable Wake-Up Functions	8-78

Safety

Definitions and Symbols

 **WARNING**

This symbol indicates high voltage. It calls your attention to items or operations that could be dangerous to you and other persons operating this equipment. Read the message and follow the instructions carefully.



This symbol is the “Safety Alert Symbol.” It occurs with either of two signal words: CAUTION or WARNING, as described below.

 **WARNING**

Indicates a potentially hazardous situation which, if not avoided, can result in serious injury or death.

 **CAUTION**

Indicates a potentially hazardous situation which, if not avoided, can result in minor to moderate injury, or serious damage to the product. The situation described in the CAUTION may, if not avoided, lead to serious results. Important safety measures are described in CAUTION (as well as WARNING).

Hazardous High Voltage

 **WARNING**

Motor control equipment and electronic controllers are connected to hazardous line voltages. When servicing drives and electronic controllers, there may be exposed components with housings or protrusions at or above line potential. Extreme care should be taken to protect against shock.

Stand on an insulating pad and make it a habit to use only one hand when checking components. Always work with another person in case an emergency occurs. Disconnect power before checking controllers or performing maintenance. Be sure equipment is properly grounded. Wear safety glasses whenever working on electronic controllers or rotating machinery.

August 2010

Cautions and Notices

Read this manual thoroughly and make sure you understand the procedures before you attempt to install, set up, or operate this 9000X AF Drives from Eaton's electrical sector.

Cautions

⚠ CAUTION

Be **ABSOLUTELY** sure not to connect two functions to one and same output in order to avoid function overruns and to ensure flawless operation.

⚠ CAUTION

The calculated model does not protect the motor if the airflow to the motor is reduced by blocked air intake grill.

Notices

Notice

The *inputs*, unlike the *outputs*, cannot be changed in RUN state.

August 2010

Chapter 1 — Basic Application

Introduction

The Basic Application is easy to use with a minimum number of parameters. It operates like the default setup of the Standard Application. It is the default setting on delivery from the factory. If any configuration changes are needed, select the Standard Application in menu M5. Fieldbus control is not available in the Basic Application, but fieldbus monitoring is the same as the Standard Application.

The parameters of the Basic Application are explained in **Chapter 8** of this manual. The explanations are arranged according to the individual ID number of the parameter.

Motor Protection Functions in the Basic Application

The Basic Application provides almost all the same protection functions as the other applications:

- External fault protection
- Input phase supervision
- Undervoltage protection
- Output phase supervision
- Earth fault protection
- Motor thermal protection
- I_{in} reference fault (auto reset)

Unlike the other applications, the Basic Application does not provide any parameters for choosing the response function or limit values for the faults. The motor thermal protection is explained in more detail on **Page A-4** in **Appendix A**.

Basic Application

Control I/O

Reference potentiometer
1 – 10 kW

Table 1-1: Basic Application Default I/O Configuration

Terminal	Signal	Description															
OPTA1																	
1	+10V _{ref}	Reference output	Voltage for potentiometer, etc.														
2	AI1+	Analog input, voltage range 0 – 10V DC	Voltage input frequency reference														
3	AI1-	I/O Ground	Ground for reference and controls														
4	AI2+	Analog input, current range 0 – 20 mA	Current input frequency reference														
5	AI2-																
6	+24V	Control voltage output	Voltage for switches. etc. max 0.1A														
7	GND	I/O ground	Ground for reference and controls														
8	DIN1	Start forward	Contact closed = start forward														
9	DIN2	Start reverse	Contact closed = start reverse														
10	DIN3	External fault input (programmable)	Contact open = no fault Contact closed = fault														
11	CMA	Common for DIN1 – DIN3	Connect to GND or +24V														
12	+24V	Control voltage output	Voltage for switches (see #6)														
13	GND	I/O ground	Ground for reference and controls														
14	DIN4	Multi-step speed select 1	<table border="1"> <tr> <td>Open</td> <td>Open</td> <td>Ref. U_{in}</td> </tr> <tr> <td>Closed</td> <td>Open</td> <td>Multi-step ref.1</td> </tr> <tr> <td>Open</td> <td>Closed</td> <td>Multi-step ref.2</td> </tr> <tr> <td>Closed</td> <td>Closed</td> <td>Ref I_{in}</td> </tr> </table>	Open	Open	Ref. U _{in}	Closed	Open	Multi-step ref.1	Open	Closed	Multi-step ref.2	Closed	Closed	Ref I _{in}		
Open	Open	Ref. U _{in}															
Closed	Open	Multi-step ref.1															
Open	Closed	Multi-step ref.2															
Closed	Closed	Ref I _{in}															
15	DIN5	Multi-step speed select 2															
16	DIN6	Fault reset	Contact open = no action Contact closed = fault reset														
17	CMB	Common for DIN4 – DIN6	Connect to GND or +24V														
18	AO1+	Output frequency Analog output	Programmable Range 0 – 20 mA/R _L , max. 500W														
19	AO1-																
20	DO1	Digital output READY	Programmable Open collector, I ≤ 50 mA, U ≤ 48V DC														
OPTA2																	
21	RO1	Relay output 1 RUN															
22	RO1																
23	RO1																
24	RO2	Relay output 2 FAULT															
25	RO2																
26	RO2																

Note: For more information on jumper selections, see the *9000X AF Drives User Manual, Chapter 4.*

**Jumper Block X3:
CMA and CMB Grounding**

- CMB connected to GND
- CMA connected to GND
- CMB isolated from GND
- CMA isolated from GND
- CMB and CMA internally connected together, isolated from GND

= Factory default.

Basic Application

Basic Application — Parameter Lists

On the next pages you will find the lists of parameters within the respective parameter groups. The parameter descriptions are given in **Chapter 8**.

Column explanations:

Code	=	Location indication on the keypad; Shows the operator the present parameter number
Parameter	=	Name of parameter
Min	=	Minimum value of parameter
Max	=	Maximum value of parameter
Unit	=	Unit of parameter value; Given if available
Default	=	Value preset by factory
Cust	=	Customer's own setting
ID	=	ID number of the parameter
①	=	Parameter value can only be changed after the drive has been stopped
②	=	Use TTF method to program these parameters. See Page 6-3 .

Monitoring Values (Control Keypad: Menu M7)

The monitoring values are the actual values of parameters and signals as well as statuses and measurements. Monitoring values cannot be edited.

See *9000X AF Drives User Manual, Chapter 5* for more information.

Table 1-2: Monitoring Values

Code	Parameter	Unit	ID	Description
V1.1	Output frequency	Hz	1	Output frequency to motor
V1.2	Frequency reference	Hz	25	Frequency reference to motor control
V1.3	Motor speed	rpm	2	Motor speed in rpm
V1.4	Motor current	A	3	
V1.5	Motor torque	%	4	In % of Motor nominal torque
V1.6	Motor power	%	5	Motor shaft power
V1.7	Motor voltage	V	6	
V1.8	DC Bus voltage	V	7	
V1.9	Unit temperature	∞C	8	Heatsink temperature
V1.10	Motor temperature	%	9	Calculated motor temperature
V1.11	Voltage input	V	13	AI1
V1.12	Current input	mA	14	AI2
V1.13	DIN1, DIN2, DIN3		15	Digital input statuses
V1.14	DIN4, DIN5, DIN6		16	Digital input statuses
V1.15	DO1, RO1, RO2		17	Digital and relay output statuses
V1.16	Analog I _{out}	mA	26	AO1
M1.17	Multimonitoring items			Displays three selectable monitoring values

Basic Application

Basic Parameters (Control Keypad: M1 → G1.1)

Table 1-3: Basic Parameters — G1

Code	Parameter	Min.	Max.	Unit	Default	Cust	ID	Note
P1.1	Min frequency	0.00	Par. 1.2	Hz	0.00		101	
P1.2	Max frequency	Par. 1.1	320.00	Hz	60.00		102	NOTE: If f_{max} > than the motor synchronous speed, check suitability for motor and drive system.
P1.3	Acceleration time 1	0.1	3000.0	s	3.0		103	
P1.4	Deceleration time 1	0.1	3000.0	s	3.0		104	
P1.5	Current limit	$0.1 \times I_H$	$2 \times I_H$	A	I_L		107	
P1.6 ①	Nominal voltage of the motor	180	690	V	P: 230V P: 460V P: 575V		110	Check the rating plate of the motor.
P1.7 ①	Nominal frequency of the motor	30.00	320.00	Hz	60.00		111	Check the rating plate of the motor.
P1.8 ①	Nominal speed of the motor	300	20 000	rpm	1720		112	Check the rating plate of the motor. The default applies for a 4-pole motor and a nominal size frequency converter.
P1.9 ①	Nominal current of the motor	$0.1 \times I_H$	$2 \times I_H$	A	I_H		113	Check the rating plate of the motor.
P1.10	Preset speed 1	0.00	Par 1.1.2	Hz	10.00		105	Speeds preset by operator
P1.11	Preset speed 2	0.00	Par 1.1.2	Hz	40.00		106	Speeds preset by operator
P1.12	Input phase supervision	0	3				730	0 = No action 1 = Working 2 = Fault 3 = Fault, coast

August 2010

Basic Application

Keypad Control (Control Keypad: Menu M2)

The parameters for the selection of control place and direction on the keypad are listed below. See the *Keypad Control Menu* in the *9000X AF Drives User Manual*.

Table 1-4: Keypad Control Parameters — M2

Code	Parameter	Min.	Max.	Unit	Default	Cust	ID	Note
R1.1	Keypad reference	Par. 1.1	Par. 1.2	Hz	60.00			
P1.2	Direction (on keypad)	0	1		0		123	Reverse request activated from the panel
R1.3	Stop button	0	1		1		114	0 = Limited function of Stop button 1 = Stop button always enabled
P2.4	Operate menu hide	0	1		0	1688		0 = No 1 = Yes

System Menu (Control Keypad: Menu M5)

For parameters and functions related to the general use of the drive, such as application and language selection, customized parameter sets or information about the hardware and software, see *Chapter 5* in the *9000X AF Drives User Manual*.

Expander Boards (Control Keypad: Menu M6)

The **M6** menu shows the expander and option boards attached to the control board and board-related information. For more information, see *Chapter 5* in the *9000X AF Drives User Manual*.

August 2010

Chapter 2 — Standard Application

Introduction

Select the Standard Application in menu **M5**. See *Chapter 5* of the *9000X AF Drives User Manual*.

The Standard Application is typically used in pump and fan applications and conveyors for which the Basic Application is too limited but where no special features are needed.

- The Standard Application has the same I/O signals and the same control logic as the Basic Application.
- Digital input DIN3 and all the outputs are freely programmable.

Additional functions:

- Programmable Start/Stop and Reverse signal logic
- Reference scaling
- One frequency limit supervision
- Second ramps and S-shape ramp programming
- Programmable start and stop functions
- DC-brake at stop
- One skip frequency area
- Programmable V/f curve and switching frequency
- Autorestart
- Motor thermal and stall protection: Programmable action; off, warning, fault

The parameters of the Standard Application are explained in **Chapter 8** of this manual. The explanations are arranged according to the individual ID number of the parameter.

Standard Application

Control I/O

Table 2-1: Standard Application Default I/O Configuration

Terminal	Signal	Description			
OPTA1					
1	+10V _{ref}	Reference output	Voltage for potentiometer, etc.		
2	AI1+	Analog input, voltage range 0 – 10V DC	Voltage input frequency reference		
3	AI1-	I/O Ground	Ground for reference and controls		
4	AI2+	Analog input, current range 0 – 20 mA	Current input frequency reference		
5	AI2-				
6	+24V ●	Control voltage output	Voltage for switches, etc. max 0.1A		
7 ●	GND	I/O ground	Ground for reference and controls		
8	DIN1	Start forward (programmable)	Contact closed = start forward		
9	DIN2	Start reverse (programmable)	Contact closed = start reverse		
10	DIN3	External fault input (programmable)	Contact open = no fault Contact closed = fault		
11	CMA	Common for DIN1 – DIN3	Connect to GND or +24V		
12	+24V ●	Control voltage output	Voltage for switches (see #6)		
13 ●	GND	I/O ground	Ground for reference and controls		
14	DIN4	Multi-step speed select 1	DIN4	DIN5	Frequency ref.
15	DIN5	Multi-step speed select 2	Open Closed Open Closed	Open Open Closed Closed	Ref. U _{in} Multi-step ref. 1 Multi-step ref. 2 Ref. I _{in}
16	DIN6	Fault reset	Contact open = no action Contact closed = fault reset		
17	CMB	Common for DIN4 – DIN6	Connect to GND or +24V		
18	AO1+	Output frequency Analog output	Programmable Range 0 – 20 mA/R _L , max. 500W		
19 ●	AO1-				
20	DO1	Digital output READY	Programmable Open collector, I ≤ 50 mA, U ≤ 48V DC		
OPTA2					
21	RO1	Relay output 1 RUN			
22	RO1				
23	RO1				
24	RO2	Relay output 2 FAULT			
25	RO2				
26	RO2				

Note: For more information on jumper selections, see the *9000X AF Drives User Manual, Chapter 4*.

**Jumper Block X3:
CMA and CMB Grounding**

- CMB connected to GND
- CMA connected to GND
- CMB isolated from GND
- CMA isolated from GND
- CMB and CMA internally connected together, isolated from GND

= Factory default.

Standard Application

Standard Application — Parameter Lists

On the next pages you will find the lists of parameters within the respective parameter groups. The parameter descriptions are given in **Chapter 8**. The descriptions are arranged according to the **ID number** of the parameter.

Column explanations:

- Code = Location indication on the keypad; Shows the operator the present parameter number
- Parameter = Name of parameter
- Min = Minimum value of parameter
- Max = Maximum value of parameter
- Unit = Unit of parameter value; Given if available
- Default = Value preset by factory
- Cust = Customer’s own setting
- ID = ID number of the parameter
- ① = Parameter value can only be changed after the drive has been stopped.
- ② = Use TTF method to program these parameters. See **Page 6-3**.

Monitoring Values (Control Keypad: Menu M7)

The monitoring values are the actual values of parameters and signals as well as statuses and measurements. Monitoring values cannot be edited.

See *9000X AF Drives User Manual, Chapter 5* for more information.

Table 2-2: Monitoring Values

Code	Parameter	Unit	ID	Description
V1.1	Output frequency	Hz	1	Output frequency to motor
V1.2	Frequency reference	Hz	25	Frequency reference to motor control
V1.3	Motor speed	rpm	2	Motor speed in rpm
V1.4	Motor current	A	3	
V1.5	Motor torque	%	4	In % of the nominal motor torque
V1.6	Motor power	%	5	Motor shaft power
V1.7	Motor voltage	V	6	
V1.8	DC Bus voltage	V	7	
V1.9	Unit temperature	∞C	8	Heatsink temperature
V1.10	Motor temperature	%	9	Calculated motor temperature
V1.11	Analog input 1	V	13	AI1
V1.12	Analog input 2	mA	14	AI2
V1.13	DIN1, DIN2, DIN3		15	Digital input statuses
V1.14	DIN4, DIN5, DIN6		16	Digital input statuses
V1.15	DO1, RO1, RO2		17	Digital and relay output statuses

Standard Application

Table 2-2: Monitoring Values (Continued)

Code	Parameter	Unit	ID	Description
V1.16	Analog I_{out}	mA	26	AO1
M1.17	Monitoring items			Displays three selectable monitoring values

Basic Parameters (Control Keypad: Menu M1 → G1.1)

Table 2-3: Basic Parameters — G1.1

Code	Parameter	Min.	Max.	Unit	Default	Cust	ID	Note
P1.1.1	Min frequency	0.00	Par. 1.1.2	Hz	0.00		101	
P1.1.2	Max frequency	Par. 1.1.1	320.00	Hz	60.00		102	NOTE: If f_{max} > than the motor synchronous speed, check suitability for motor and drive system.
P1.1.3	Acceleration time 1	0.1	3000.0	s	3.0		103	
P1.1.4	Deceleration time 1	0.1	3000.0	s	3.0		104	
P1.1.5	Current limit	$0.1 \times I_H$	$2 \times I_H$	A	I_L		107	
P1.1.6 ①	Nominal voltage of the motor	180	690	V	P: 230V P: 460V P: 575V		110	
P1.1.7 ①	Nominal frequency of the motor	30.00	320.00	Hz	60.00		111	Check the rating plate of the motor.
P1.1.8 ①	Nominal speed of the motor	300	20 000	rpm	1720		112	The default applies for a 4-pole motor and a nominal size frequency converter.
P1.1.9 ①	Nominal current of the motor	$0.1 \times I_H$	$2 \times I_H$	A	I_H		113	Check the rating plate of the motor.
P1.1.10 ①	Power Factor	0.30	1.00		0.85		120	Check the rating plate of the motor.
P1.1.11	Local Control Place	1	3		2		171	1 = I/O Terminal 2 = Keypad 3 = Fieldbus
P1.1.12	Remote Control Place	1	3		1		172	1 = I/O Terminal 2 = Keypad 3 = Fieldbus
P1.1.13 ①	Local reference	0	3		2		173	0 = AI1 1 = AI2 2 = Keypad 3 = Fieldbus
P1.1.14 ①	Remote reference	0	3		0		174	0 = AI1 1 = AI2 2 = Keypad 3 = Fieldbus
P1.1.15	Identification	0	2		0		631	0 = Not used 1 = V/Hz 2 = V/Hz with boost
P1.1.16	V/Hz Opt	0	1		0		109	0 = Not used 1 = Automatic torque boost
P1.1.17	Preset speed 1	0.00	Par. 1.1.2	Hz	10.00		105	Speeds preset by operator.
P1.1.18	Preset speed 2	0.00	Par. 1.1.2	Hz	40.00		106	

Standard Application

Input Signals (Control Keypad: Menu M1 → G1.2)

Table 2-4: Input Signals — G1.2

Code	Parameter	Min.	Max.	Unit	Default	Cust	ID	Note																
P1.2.1 ①	Start/Stop logic	0	6		0		300	<table border="1" style="width: 100%; border-collapse: collapse;"> <thead> <tr> <th style="width: 50%;">DIN1</th> <th style="width: 50%;">DIN2</th> </tr> </thead> <tbody> <tr> <td>0 Start fwd</td> <td>Start rvs</td> </tr> <tr> <td>1 Start/Stop</td> <td>Rvs/Fwd</td> </tr> <tr> <td>2 Start/Stop</td> <td>Run enable</td> </tr> <tr> <td>3 Start pulse</td> <td>Stop pulse</td> </tr> <tr> <td>4 Fwd ③</td> <td>Rvs ③</td> </tr> <tr> <td>5 Start ④/Stop</td> <td>Rvs/Fwd</td> </tr> <tr> <td>6 Start ④/Stop</td> <td>Run enable</td> </tr> </tbody> </table>	DIN1	DIN2	0 Start fwd	Start rvs	1 Start/Stop	Rvs/Fwd	2 Start/Stop	Run enable	3 Start pulse	Stop pulse	4 Fwd ③	Rvs ③	5 Start ④/Stop	Rvs/Fwd	6 Start ④/Stop	Run enable
DIN1	DIN2																							
0 Start fwd	Start rvs																							
1 Start/Stop	Rvs/Fwd																							
2 Start/Stop	Run enable																							
3 Start pulse	Stop pulse																							
4 Fwd ③	Rvs ③																							
5 Start ④/Stop	Rvs/Fwd																							
6 Start ④/Stop	Run enable																							
P1.2.2 ①	DIN3 function	0	7		1		301	0 = Not used 1 = Ext. fault. closing cont. 2 = Ext. fault. opening cont. 3 = Run enable 4 = Acc./Dec. time select. 5 = Force CP to Remote ④ 6 = Rvs (if par. 1.2.1 = 3)																
P1.2.3	Current reference offset	0	1		1		302	0 = 0 – 20mA 1 = 4 – 20mA																
P1.2.4	Reference scaling minimum value	0.00	Par. 1.2.5	Hz	0.00		303	Selects the frequency that corresponds to the min. reference signal 0.00 = No scaling																
P1.2.5	Reference scaling maximum value	0.00	320.00	Hz	0.00		304	Selects the frequency that corresponds to the max. reference signal 0.00 = No scaling																
P1.2.6	Reference inversion	0	1		0		305	0 = Not inverted 1 = Inverted																
P1.2.7	Reference filter time	0.00	10.00	s	0.10		306	0 = No filtering																
P1.2.8 ②	AI1 signal selection				A.1		377	TTF programming method used. See Page 6-3.																
P1.2.9 ②	AI2 signal selection				A.2		388	TTF programming method used. See Page 6-3.																

③ Rising edge required to start.

④ CP = control place.

Output Signals (Control Keypad: Menu M1 → G1.3)

Table 2-5: Output Signals — G1.3

Code	Parameter	Min.	Max.	Unit	Default	Cust	ID	Note
P1.3.1 ②	Analog output 1 signal selection	0			A.1		464	TTF programming method used. See Page 6-3.
P1.3.2	Analog output function	0	8		1		307	0 = Not used 1 = Output freq. (0 – f_{max}) 2 = Freq. reference (0 – f_{max}) 3 = Motor speed (0 – Motor nominal speed) 4 = Motor current (0 – I_{nMotor}) 5 = Motor torque (0 – T_{nMotor}) 6 = Motor power (0 – P_{nMotor}) 7 = Motor voltage (0 – U_{nMotor}) 8 = DC-Bus volt (0 – 1000V)
P1.3.3	Analog output filter time	0.00	10.00	s	1.00		308	0 = No filtering

Standard Application

Table 2-5: Output Signals — G1.3 (Continued)

Code	Parameter	Min.	Max.	Unit	Default	Cust	ID	Note
P1.3.4	Analog output inversion	0	1		0		309	0 = Not inverted 1 = Inverted
P1.3.5	Analog output minimum	0	1		0		310	0 = 0 mA 1 = 4 mA
P1.3.6	Analog output scale	10	1000	%	100		311	
P1.3.7	Digital output 1 function	0	16		1		312	0 = Not used 1 = Ready 2 = Run 3 = Fault 4 = Fault inverted 5 = FC overheat warning 6 = Ext. fault or warning 7 = Ref. fault or warning 8 = Warning 9 = Reversed 10 = Preset speed 1 11 = At speed 12 = Mot. regulator active 13 = OP freq. limit 1 superv. 14 = Remote Control Active 15 = Thermistor fault/warnng 16 = Fieldbus input data
P1.3.8	Relay output 1 function	0	16		2		313	Same as parameter 1.3.7
P1.3.9	Relay output 2 function	0	16		3		314	Same as parameter 1.3.7
P1.3.10	Output frequency limit 1 supervision	0	2		0		315	0 = No limit 1 = Low limit supervision 2 = High limit supervision
P1.3.11	Output frequency limit 1; Supervised value	0.00	320.00	Hz	0.00		316	
P1.3.12 ^②	Analog output 2 signal selection	0			0.1		471	TTF programming method used. See Page 6-3 .
P1.3.13	Analog output 2 function	0	8		4		472	Same as parameter 1.3.2
P1.3.14	Analog output 2 filter time	0.00	10.00	s	1.00		473	0 = No filtering
P1.3.15	Analog output 2 inversion	0	1		0		474	0 = Not inverted 1 = Inverted
P1.3.16	Analog output 2 minimum	0	1		0		475	0 = 0 mA 1 = 4 mA
P1.3.17	Analog output 2 scaling	10	1000	%	100		476	

August 2010

Standard Application

Drive Control Parameters (Control Keypad: Menu M1 → G1.4)

Table 2-6: Drive Control Parameters — G1.4

Code	Parameter	Min.	Max.	Unit	Default	Cust	ID	Note
P1.4.1	Ramp 1 shape	0.0	10.0	s	0.0		500	0 = Linear >0 = S-curve ramp time
P1.4.2	Ramp 2 shape	0.0	10.0	s	0.0		501	0 = Linear >0 = S-curve ramp time
P1.4.3	Acceleration time 2	0.1	3000.0	s	10.0		502	
P1.4.4	Deceleration time 2	0.1	3000.0	s	10.0		503	
P1.4.5 [Ⓞ]	Brake chopper	0	4		0		504	0 = Disabled 1 = Used when running 2 = External brake chopper 3 = Used when stopped/running 4 = Used when running (no testing)
P1.4.6	Start function	0	1		0		505	0 = Ramp 1 = Flying start
P1.4.7	Stop function	0	3		1		506	0 = Coasting 1 = Ramp 2 = Ramp+Run enable coast 3 = Coast+Run enable ramp
P1.4.8	DC braking current	0.00	I_L	A	$0.7 \times I_H$		507	
P1.4.9	DC braking time at stop	0.00	600.00	s	0.00		508	0 = DC brake is off at stop
P1.4.10	Frequency to start DC braking during ramp stop	0.10	10.00	Hz	1.50		515	
P1.4.11	DC braking time at start	0.00	600.00	s	0.00		516	0 = DC brake is off at start
P1.4.12	Flux brake	0	1		0		520	0 = Off 1 = On
P1.4.13	Flux braking current	$0.1 \times I_H$	I_L	A	I_H		519	

Skip Frequency Parameters (Control Keypad: Menu M1 → G1.5)

Table 2-7: Skip Frequency Parameters — G1.5

Code	Parameter	Min.	Max.	Unit	Default	Cust	ID	Note
P1.5.1	Skip frequency range 1 low limit	0.00	Par. 1.5.2	Hz	0.00		509	
P1.5.2	Skip frequency range 1 high limit	0.00	Par. 1.1.2	Hz	0.0		510	0 = Skip frequency range 1 not used
P1.5.3	Skip frequency acc./dec. ramp	0.1	10.0		1.0		518	

Standard Application

Motor Control Parameters (Control Keypad: Menu M1 → G1.6)

Table 2-8: Motor Control Parameters — G1.6

Code	Parameter	Min.	Max.	Unit	Default	Cust	ID	Note
P1.6.1 ①	Motor control mode	0	1/6		0		600	SVX: 0 = Frequency control 1 = Speed control Additionally for SPX: 2 = Torque control 3 = Closed loop speed ctrl 4 = Closed loop torque ctrl
P1.6.2 ①	V/Hz optimization	0	1		0		109	0 = Not used 1 = Automatic torque boost
P1.6.3 ①	V/Hz ratio selection	0	3		0		108	0 = Linear 1 = Squared 2 = Programmable 3 = Linear with flux optim.
P1.6.4 ①	Field weakening point	8.00	320.00	Hz	60.00		602	
P1.6.5 ①	Voltage at field weakening point	10.00	200.00	%	100.00		603	$n\% \times U_{nmot}$
P1.6.6 ①	V/Hz curve midpoint frequency	0.00	Par. 1.6.4	Hz	60.00		604	
P1.6.7 ①	V/Hz curve midpoint voltage	0.00	100.00	%	100.00		605	$n\% \times U_{nmot}$ Parameter max. value = par. 2.6.5
P1.6.8 ①	Output voltage at zero frequency	0.00	40.00	%	1.30		606	$n\% \times U_{nmot}$
P1.6.9	Switching frequency	1.0	Varies	kHz	Varies		601	See Table 8-12 on Page 8-57 for exact values
P1.6.10	Overvoltage controller	0	2		1		607	0 = Not used 1 = Used (no ramping) 2 = Used (ramping)
P1.6.11	Undervoltage controller	0	1		1		608	1 = Yes 2 = No
P1.6.12	Load Drooping	0.00	100.00		0.00		620	Drooping % of nominal speed at nominal torque
P1.6.13	Identification	0	1		0		631	0 = Not used 1 = OL v/f Ratio 2 = OL v/f and Boost

Closed Loop parameter group 1.6.14 (SPX only)

P1.6.14.1	Magnetizing current	0.00	100.00	A	0.00		612	
P1.6.14.2	Speed control P gain	0	1000		30		613	
P1.6.14.3	Speed control I time	0.0	500.0	ms	30.0		614	
P1.6.14.5	Acceleration compensation	0.00	300.00	s	0.00		626	
P1.6.14.6	Slip adjust	0	500	%	100		619	
P1.6.14.7	Magnetizing current at start	MotCurr Min	MotCurr Max	A	0.00		627	
P1.6.14.8	Magnetizing time at start	0.0	600.0	s	0.0		628	

August 2010

Standard Application

Motor Control Parameters — G1.6

Code	Parameter	Min.	Max.	Unit	Default	Cust	ID	Note
Closed Loop parameter group 1.6.14 (SPX only) (Continued)								
P1.6.14.9	0-speed time at start	0	32000	ms	100		615	
P1.6.14.10	0-speed time at stop	0	32000	ms	100		616	
P1.6.14.11	Start-up torque	0	3		0		621	0 = Not used 1 = Torque memory 2 = Torque reference 3 = Start-up torque fwd/rev
P1.6.14.12	Start-up torque FWD	-300.0	300.0	s	0.0		633	
P1.6.14.13	Start-up torque REV	-300.0	300.0	s	0.0		634	
P1.6.14.15	Encoder filter time	0	1000	ms	0		618	
P1.6.14.17	Current control P gain	0.00	100.00	%	40.00		617	

Protections (Control Keypad: Menu M1 → G1.7)

Table 2-9: Protections — G1.7

Code	Parameter	Min.	Max.	Unit	Default	Cust	ID	Note
P1.7.1	Response to reference fault	0	6		6		700	0 = No response 1 = Warning 2 = Warning+Previous Freq. 3 = Wrng+PresetFreq 1.7.2 4 = Fault.stop acc. to 1.4.7 5 = Fault.stop by coasting 6 = Fault, Restart
P1.7.2	Reference fault frequency	0.00	Par. 1.1.2	Hz	0.00		728	
P1.7.3	Response to external fault	0	3		2		701	0 = No response 1 = Warning 2 = Fault.stop acc. to 1.4.7 3 = Fault.stop by coasting
P1.7.4	Input phase supervision	0	3		3		730	
P1.7.5	Response to undervoltage fault	1	3		0		727	
P1.7.6	Output phase supervision	0	3		2		702	
P1.7.7	Earth fault protection	0	3		2		703	
P1.7.8	Thermal protection of the motor	0	3		2		704	
P1.7.9	Motor ambient temperature factor	-100.0	100.0	%	0.0		705	
P1.7.10	Motor cooling factor at zero speed	0.0	150.0	%	40.0		706	
P1.7.11	Motor thermal time constant	1	200	min	45		707	
P1.7.12	Motor duty cycle	0	100	%	100		708	
P1.7.13	Stall protection	0	3		0		709	0 = No response 1 = Warning 2 = Fault.stop acc. to 1.4.7 3 = Fault.stop by coasting

Standard Application

Table 2-9: Protections — G1.7 (Continued)

Code	Parameter	Min.	Max.	Unit	Default	Cust	ID	Note
P1.7.14	Stall current	0.1	$I_{nMotor} \times 2$	A	I_L		710	
P1.7.15	Stall time limit	1.00	120.00	s	15.00		711	
P1.7.16	Stall frequency limit	1.0	Par. 1.1.2	Hz	25.0		712	
P1.7.17	Underload protection	0	3		0		713	0 = No response 1 = Warning 2 = Fault.stop acc. to 1.4.7 3 = Fault.stop by coasting
P1.7.18	Field weakening area load	10	150	%	50		714	
P1.7.19	Zero frequency load	5.0	150.0	%	10.0		715	
P1.7.20	Underload protection time limit	2	600	s	20		716	
P1.7.21	Response to thermistor fault	0	3		2		732	0 = No response 1 = Warning 2 = Fault.stop acc. to 1.4.7 3 = Fault.stop by coasting
P1.7.22	Response to fieldbus fault	0	3		2		733	See P1.7.21
P1.7.23	Response to slot fault	0	3		2		734	See P1.7.21
P1.7.24	FB MCW Bit 15	0	2		0		771	0 = No action 1 = Fault low 2 = Fault high

Autorestart Parameters (Control Keypad: Menu M1 → G1.8)

Table 2-10: Autorestart Parameters — G1.8

Code	Parameter	Min.	Max.	Unit	Default	Cust	ID	Note
P1.8.1	Wait time	0.10	10.00	s	0.50		717	
P1.8.2	Trial time	0.00	60.00	s	30.00		718	
P1.8.3	Start function	0	2		0		719	0 = Ramp 1 = Flying start 2 = According to par. 1.4.6
P1.8.4	Number of tries after undervoltage trip	0	10		0		720	
P1.8.5	Number of tries after overvoltage trip	0	10		0		721	
P1.8.6	Number of tries after overcurrent trip	0	3		0		722	
P1.8.7	Number of tries after reference trip	0	10		0		723	
P1.8.8	Number of tries after motor temperature fault trip	0	10		0		726	
P1.8.9	Number of tries after external fault trip	0	10		0		725	
P1.8.10	Number of tries after underload fault trip	0	10		0		738	

August 2010

Standard Application

Keypad Control (Control Keypad: Menu M2)

The parameters for the selection of control place and direction on the keypad are listed below. See the Keypad control menu in the *9000X AF Drives User Manual*.

Table 2-11: Keypad Control Parameters — M2

Code	Parameter	Min.	Max.	Unit	Default	Cust	ID	Note
P2.1	Control place	0	3		0		1685	0 = Keypad L/R 1 = Local 2 = Remote 3 = I/O force
R2.1	Keypad reference	Par. 1.1.1	Par. 1.1.2	Hz				
P2.3	Direction (on keypad)	0	1		0		123	0 = Forward 1 = Reverse
P2.4	Stop button	0	1		1		114	0 = Limited function of Stop button 1 = Stop button always enabled
P2.5	Operate menu hide	0	1		0		1688	0 = No 1 = Yes

System Menu (Control Keypad: Menu M5)

For parameters and functions related to the general use of the drive, such as application and language selection, customized parameter sets or information about the hardware and software, see *Chapter 5* in the *9000X AF Drives User Manual*.

Expander Boards (Control Keypad: Menu M6)

The **M6** menu shows the expander and option boards attached to the control board and board-related information. For more information, see *Chapter 5* in the *9000X AF Drives User Manual*.

August 2010

Chapter 3 — Local/Remote Control Application

Introduction

Select the Local/Remote Control Application in menu **M5**. See *Chapter 5* of the *9000X AF Drives User Manual*.

- The Local/Remote Application utilizes digital input DIN6 to select between Local and Remote control. For each control location, the frequency can be selected from either the keypad, I/O terminals, or fieldbus.
- All outputs are freely programmable.

Additional functions:

- Programmable Start/Stop and Reverse signal logic
- Second I/O programmable stay/stop and reverse signal logic
- Reference scaling
- One frequency limit supervision
- Second ramps and S-shape ramp programming
- Programmable start and stop functions
- DC-brake at stop
- One skip frequency area
- Programmable v/f curve and switching frequency
- Autorestart
- Motor thermal and stall protection: Programmable action; off, warning, fault

The parameters of the Local/Remote Control Application are explained in **Chapter 8** of this manual. The explanations are arranged according to the individual ID number of the parameter.

Local/Remote Control Application

Control I/O

Table 3-1: Local/Remote Application Default I/O Configuration

Terminal	Signal	Description	
OPTA1			
1	+10V _{ref}	Reference output Voltage for potentiometer, etc.	
2	AI1+	Analog input, voltage range 0 – 10V DC Place B input frequency reference range 0 – 10V DC	
3	AI1-	I/O Ground Ground for reference and controls	
4	AI2+	Analog input, current range 0 – 20 mA Place A frequency reference range 0 – 20 mA	
5	AI2-		
6	+24V ●	Control voltage output Voltage for switches, etc. max 0.1A	
7	● GND	I/O ground Ground for reference and controls	
8	DIN1	Remote start forward (programmable) Contact closed = start forward	
9	DIN2	Remote start reverse (programmable) Contact closed = start reverse	
10	DIN3	External fault input (programmable) Contact open = no fault Contact closed = fault	
11	CMA	Common for DIN1 – DIN3 Connect to GND or +24V	
12	+24V ●	Control voltage output Voltage for switches (see terminal 6)	
13	● GND	I/O ground Ground for reference and controls	
14	DIN4	Local start forward (programmable) Contact closed = start forward	
15	DIN5	Local start reverse (programmable) Contact closed = start reverse	
16	DIN6	Local/Remote selection Contact open = Local is active Contact closed = Remote is active	
17	CMB	Common for DIN4 – DIN6 Connect to GND or +24V	
18	AO1+	Output frequency Analog output Programmable Range 0 – 20 mA, R _L , max. 500W	
19	● AO1-		
20	DO1	Digital output READY Programmable Open collector, I ≤ 50 mA, V ≤ 48V DC	
OPTA2			
21	RO1	Relay output 1 RUN	Programmable
22	RO1		
23	RO1		
24	RO2	Relay output 2 FAULT	Programmable
25	RO2		
26	RO2		

Note: For more information on jumper selections, see the *9000X AF Drives User Manual, Chapter 4.*

**Jumper Block X3:
CMA and CMB Grounding**

- CMA connected to GND
- CMB connected to GND
- CMA isolated from GND
- CMB isolated from GND
- CMA and CMB internally connected together, isolated from GND

= Factory default.

August 2010

Local/Remote Control Application

Local/Remote Control Application — Parameter Lists

On the next pages you will find the lists of parameters within the respective parameter groups. The parameter descriptions are given in **Chapter 8**.

Column explanations:

- Code = Location indication on the keypad; Shows the operator the present parameter number
- Parameter = Name of parameter
- Min = Minimum value of parameter
- Max = Maximum value of parameter
- Unit = Unit of parameter value; Given if available
- Default = Value preset by factory
- Cust = Customer's own setting
- ID = ID number of the parameter
- ① = Parameter value can only be changed after the drive has been stopped.
- ② = Use TTF method to program these parameters. See **Page 6-3**.

Monitoring Values (Control Keypad: Menu M7)

The monitoring values are the actual values of parameters and signals as well as statuses and measurements. Monitoring values cannot be edited.

See *9000X AF Drives User Manual, Chapter 5* for more information.

Table 3-2: Monitoring Values

Code	Parameter	Unit	ID	Description
V1.1	Output frequency	Hz	1	Output frequency to motor
V1.2	Frequency reference	Hz	25	Frequency reference to motor control
V1.3	Motor speed	rpm	2	Motor speed in rpm
V1.4	Motor current	A	3	
V1.5	Motor torque	%	4	In % of motor nominal torque
V1.6	Motor power	%	5	Motor shaft power
V1.7	Motor voltage	V	6	
V1.8	DC Bus voltage	V	7	
V1.9	Unit temperature	°C	8	Heatsink temperature
V1.10	Motor temperature	%	9	Calculated motor temperature
V1.11	Analog input 1	V	13	AI1
V1.12	Analog input 2	mA	14	AI2
V1.13	DIN1, DIN2, DIN3		15	Digital input statuses
V1.14	DIN4, DIN5, DIN6		16	Digital input statuses
V1.15	DO1, RO1, RO2		17	Digital and relay output statuses
V1.16	Analog I _{out}	mA	26	AO1
M1.17	Multimonitoring items			Displays three selectable monitoring values

Local/Remote Control Application

Basic Parameters (Control Keypad: Menu M1 → G1.1)

Table 3-3: Basic Parameters — G1.1

Code	Parameter	Min.	Max.	Unit	Default	Cust	ID	Note
P1.1.1	Min frequency	0.00	Par. 1.1.2	Hz	0.00		101	
P1.1.2	Max frequency	Par. 1.1.1	320.00	Hz	60.00		102	NOTE: If f_{\max} > than the motor synchronous speed, check suitability for motor and drive system.
P1.1.3	Acceleration time 1	0.1	3000.0	s	3.0		103	
P1.1.4	Deceleration time 1	0.1	3000.0	s	3.0		104	
P1.1.5	Current limit	$0.1 \times I_H$	$2 \times I_H$	A	I_L		107	
P1.1.6 ①	Nominal voltage of the motor	180	690	V	P: 230V P: 460V P: 575V		110	
P1.1.7 ①	Nominal frequency of the motor	30.00	320.00	Hz	60.00		111	Check the rating plate of the motor.
P1.1.8 ①	Nominal speed of the motor	300	20 000	rpm	1720		112	The default applies for a 4-pole motor and a nominal size frequency converter.
P1.1.9 ①	Nominal current of the motor	$0.1 \times I_H$	$2 \times I_H$	A	I_H		113	Check the rating plate of the motor.
P1.1.10 ①	Power Factor	0.30	1.00		0.85		120	Check the rating plate of the motor.
P1.1.11	Local Control Place	1	4		2		171	1 = I/O Terminal 2 = Keypad 3 = Fieldbus 4 = I/O Terminal B
P1.1.12	Remote Control Place	1	4		1		172	1 = I/O Terminal 2 = Keypad 3 = Fieldbus 4 = I/O Terminal B
P1.1.13	Local reference	0	4		2		173	0 = AI1 1 = AI2 2 = Keypad 3 = Fieldbus 4 = Motor potentiometer
P1.1.14	Remote reference	0	3		0		174	0 = AI1 1 = AI2 2 = Keypad 3 = Fieldbus
P1.1.15	Identification	0	2		0		631	0 = Not used 1 = V/Hz 2 = V/Hz with boost
P1.1.16	V/Hz Opt	0	1		0		109	0 = Not used 1 = Automatic torque boost
P1.1.17	Jogging speed reference	0.00	Par. 1.1.2	Hz	0.00		124	

Local/Remote Control Application

Input Signals (Control Keypad: Menu M1 → G1.2)

Table 3-4: Input Signals — G1.2

Code	Parameter	Min.	Max.	Unit	Default	Cust	ID	Note	
P1.2.1 ①	Start/Stop logic selection	0	8		0		300	DIN1	DIN2
								0 Start fwd 1 Start/Stop 2 Start/Stop 3 Start pulse 4 Start fwd 5 Fwd ③ 6 Start ④/Stop 7 Start ④/Stop 8 Start fwd*	Start rvs Reverse Run enable Stop pulse Mot.pot.UP Rvs ③ Rvs/Fwd Run enable Mot.pot.UP
P1.2.2 ①	DIN3 function	0	13		1		301	0 = Not used 1 = Ext. fault. closing cont. 2 = Ext. fault. opening cont. 3 = Run enable 4 = Acc./Dec. time select. 5 = Rvs (if par. 1.2.1 = 3) 6 = Jogging speed 7 = Fault reset 8 = Acc./Dec. operation prohibit 9 = DC Braking command 10 = Motor potentiometer DOWN	
P1.2.3	AI1 signal selection	0			A.1		337	TTF programming method used. See Page 6-3 .	
P1.2.4	AI1 signal inversion	0	1		0		323	Analog input 1 reference inversion yes/no	
P1.2.5	AI1 signal filter time	0.00	10.00	s	0.10		324	Analog input 1 reference filter time, constant	
P1.2.6	AI2 signal selection	0			A.2		388	TTF programming method used. See Page 6-3 .	
P1.2.7	AI2 signal range	0	2		1		325	0 = 0 – 20 mA ⑤ 1 = 4 – 20 mA ⑤ 2 = custom setting range	
P1.2.8	AI2 custom setting minimum	0.00	100.00	%	0.00		326	Analog input 2 scale minimum	
P1.2.9	AI2 custom setting maximum	0.00	100.00	%	100.00		327	Analog input 2 scale maximum	

① Rising edge required to start.

④ CP = control place.

⑤ Remember to place jumpers of block X2 accordingly. See *9000X AF Drives User Manual, Chapter 4*.

Local/Remote Control Application

Table 3-4: Input Signals — G1.2 (Continued)

Code	Parameter	Min.	Max.	Unit	Default	Cust	ID	Note	
P1.2.10	AI2 signal inversion	0	1		0		328	Analog input 2 reference inversion yes/no	
P1.2.11	AI2 signal filter time	0.00	10.00	s	0.10		329	Analog input 2 reference filter time, constant	
P1.2.12 ^①	Place B Start/Stop logic selection	0	6		0		363	DIN4	DIN5
								0 Start fwd 1 Start/Stop 2 Start/Stop 3 Start pulse 4 Fwd ^③ 5 Start ^③ /Stop 6 Start ^③ /Stop	Start rvs Rvs/Fwd Run enable Stop pulse Stop pulse Rvs ^③ Rvs/Fwd Run enable
P1.2.13	Reference scaling minimum value	0.00	par. 1.2.17	Hz	0.00		303	Selects the frequency that corresponds to the min. reference signal	
P1.2.14	Reference scaling maximum value	0.00	320.00	Hz	0.00		304	Selects the frequency that corresponds to the max. reference signal 0.00 = No scaling >0 = scaled max. value	
P1.2.15	Motor potentiometer ramp time	0.1	2000.0	Hz/s	10.0		331		
P1.2.16	Motor potentiometer frequency reference memory reset	0	2		1		367	0 = No reset 1 = Reset if stopped or powered down 2 = Reset if powered down	
P1.2.17	Start pulse memory	0	1		0		498	0 = Run state not copied 1 = Run state copied	

^③ Rising edge required to start.

August 2010

Local/Remote Control Application

Output Signals (Control Keypad: Menu M1 → G1.3)

Table 3-5: Output Signals — G1.3

Code	Parameter	Min.	Max.	Unit	Default	Cust	ID	Note
P1.3.1 ②	AO1 signal selection	0			A.1		464	TTF programming method used. See Page 6-3 .
P1.3.2	Analog output function	0	8		1		307	0 = Not used 1 = Output freq. ($0 - f_{max}$) 2 = Freq. reference ($0 - f_{max}$) 3 = Motor speed ($0 -$ Motor nominal speed) 4 = Motor current ($0 - I_{nMotor}$) 5 = Motor torque ($0 - T_{nMotor}$) 6 = Motor power ($0 - P_{nMotor}$) 7 = Motor voltage ($0 - U_{nMotor}$) 8 = DC-bus volt ($0 - 1000V$)
P1.3.3	Analog output filter time	0.00	10.00	s	1.00		308	0 = No filtering
P1.3.4	Analog output inversion	0	1		0		309	0 = Not inverted 1 = Inverted
P1.3.5	Analog output minimum	0	1		0		310	0 = 0 mA 1 = 4 mA
P1.3.6	Analog output scale	10	1000	%	100		311	
P1.3.7	Digital output 1 function	0	22		1		312	0 = Not used 1 = Ready 2 = Run 3 = Fault 4 = Fault inverted 5 = FC overheat warning 6 = Ext. fault or warning 7 = Ref. fault or warning 8 = Warning 9 = Reversed 10 = Jogging spd selected 11 = At speed 12 = Mot. regulator active 13 = OP freq.limit superv. 1 14 = OP freq.limit superv. 2 15 = Torque limit superv. 16 = Ref. limit superv. 17 = Ext. brake control 18 = Remote control active 19 = FC temp. limit superv. 20 = Unrequested rotation direction 21 = Ext. brake control inverted 22 = Thermistor fault/warn.
P1.3.8	Relay output 1 function	0	22		2		313	Same as parameter 1.3.7
P1.3.9	Relay output 2 function	0	22		3		314	Same as parameter 1.3.7
P1.3.10	Output frequency limit 1 supervision	0	2		0		315	0 = No limit 1 = Low limit supervision 2 = High limit supervision

Local/Remote Control Application

Output Signals — G1.3 (Continued)

Code	Parameter	Min.	Max.	Unit	Default	Cust	ID	Note
P1.3.11	Output frequency limit 1; Supervision value	0.00	320.00	Hz	0.00		316	
P1.3.12	Output frequency limit 2 supervision	0	2		0		346	0 = No limit 1 = Low limit supervision 2 = High limit supervision
P1.3.13	Output frequency limit 2; Supervision value	0.00	320.00	Hz	0.00		347	
P1.3.14	Torque limit supervision function	0	2		0		348	0 = No 1 = Low limit 2 = High limit
P1.3.15	Torque limit supervision value	0.0	200.0	%	0.0		349	
P1.3.16	Reference limit supervision function	0	2		0		350	0 = No 1 = Low limit 2 = High limit
P1.3.17	Reference limit supervision value	0.0	100.0	%	0.0		351	
P1.3.18	External brake Off-delay	0.0	100.0	s	0.5		352	
P1.3.19	External brake On-delay	0.0	100.0	s	1.5		353	
P1.3.20	Frequency converter temperature limit supervision	0	2		0		354	0 = No 1 = Low limit 2 = High limit
P1.3.21	Frequency converter temperature limit value	-10	75	°C	0		355	
P1.3.22	Analog output 2 signal selection	0			0.1		471	TTF programming method used. See Page 6-3 .
P1.3.23	Analog output 2 function	0	8		4		472	Same as parameter 1.3.2
P1.3.24	Analog output 2 filter time	0.00	10.00	s	1.00		473	0 = No filtering
P1.3.25	Analog output 2 inversion	0	1		0		474	0 = Not inverted 1 = Inverted
P1.3.26	Analog output 2 minimum	0	1		0		475	0 = 0 mA 1 = 4 mA
P1.3.27	Analog output 2 scaling	10	1000	%	100		476	

August 2010

Local/Remote Control Application

Drive Control Parameters (Control Keypad: Menu M1 → G1.4)

Table 3-6: Drive Control Parameters — G1.4

Code	Parameter	Min.	Max.	Unit	Default	Cust	ID	Note
P1.4.1	Ramp 1 shape	0.0	10.0	s	0.0		500	0 = Linear >0 = S-curve ramp time
P1.4.2	Ramp 2 shape	0.0	10.0	s	0.0		501	0 = Linear >0 = S-curve ramp time
P1.4.3	Acceleration time 2	0.1	3000.0	s	10.0		502	
P1.4.4	Deceleration time 2	0.1	3000.0	s	10.0		503	
P1.4.5 [Ⓢ]	Brake chopper	0	4		0		504	0 = Disabled 1 = Used when running 2 = External brake chopper 3 = Used when stopped/ running 4 = Used when running (no testing)
P1.4.6	Start function	0	1		0		505	0 = Ramp 1 = Flying start
P1.4.7	Stop function	0	3		1		506	0 = Coasting 1 = Ramp 2 = Ramp+Run enable coast 3 = Coast+Run enable ramp
P1.4.8	DC braking current	0.0 x I _H	2 x I _H	A	0.7 x I _H		507	
P1.4.9	DC braking time at stop	0.00	600.00	s	0.00		508	0 = DC brake is off at stop
P1.4.10	Frequency to start DC braking during ramp stop	0.10	10.00	Hz	1.50		515	
P1.4.11	DC braking time at start	0.00	600.00	s	0.00		516	0 = DC brake is off at start
P1.4.12	Flux brake	0	1		0		520	0 = Off 1 = On
P1.4.13	Flux braking current	0.1 x I _H	2 x I _H	A	I _H		519	

Local/Remote Control Application

Skip Frequency Parameters (Control Keypad: Menu M1 → G1.5)

Table 3-7: Skip Frequency Parameters — G1.5

Code	Parameter	Min.	Max.	Unit	Default	Cust	ID	Note
P1.5.1	Skip frequency range 1 low limit	0.00	par. 1.5.2	Hz	0.00		509	
P1.5.2	Skip frequency range 1 high limit	0.00	par. 1.1.2	Hz	0.0		510	0 = Skip frequency range 1 not used
P1.5.3	Skip frequency range 2 low limit	0.00	par. 1.5.2	Hz	0.00		511	
P1.5.4	Skip frequency range 2 high limit	0.00	par. 1.1.2	Hz	0.0		512	0 = Skip frequency range 2 not used
P1.5.5	Skip frequency range 3 low limit	0.00	par. 1.5.2	Hz	0.00		513	
P1.5.6	Skip frequency range 3 high limit	0.00	par. 1.1.2	Hz	0.0		514	0 = Skip frequency range 3 not used
P1.5.7	Skip frequency acc./dec. ramp	0.1	10.0		1.0		518	

Motor Control Parameters (Control Keypad: Menu M1 → G1.6)

Table 3-8: Motor Control Parameters — G1.6

Code	Parameter	Min.	Max.	Unit	Default	Cust	ID	Note
P1.6.1 [Ⓢ]	Motor control mode	0	1/6		0		600	0 = Frequency control 1 = Speed control Additionally for SPX: 2 = Torque control 3 = Closed loop speed ctrl 4 = Closed loop torque ctrl
P1.6.2 [Ⓢ]	V/Hz optimization	0	1		0		109	0 = Not used 1 = Automatic torque boost
P1.6.3 [Ⓢ]	V/Hz ratio selection	0	3		0		108	0 = Linear 1 = Squared 2 = Programmable 3 = Linear with flux optim.
P1.6.4 [Ⓢ]	Field weakening point	8.00	320.00	Hz	60.00		602	
P1.6.5 [Ⓢ]	Voltage at field weakening point	10.00	200.00	%	100.00		603	$n\% \times U_{nmot}$
P1.6.6 [Ⓢ]	V/Hz curve midpoint frequency	0.00	Par. 1.6.4	Hz	60.00		604	
P1.6.7 [Ⓢ]	V/Hz curve midpoint voltage	0.00	100.00	%	100.00		605	$n\% \times U_{nmot}$ Parameter max. value = par. 1.6.5

August 2010

Local/Remote Control Application

Table 3-8: Motor Control Parameters — G1.6 (Continued)

Code	Parameter	Min.	Max.	Unit	Default	Cust	ID	Note
P1.6.8 ①	Output voltage at zero frequency	0.00	40.00	%	1.30		606	$n\% \times U_{nmot}$
P1.6.9	Switching frequency	1.0	Varies	kHz	Varies		601	See Table 8-12 on Page 8-57 for exact values
P1.6.10	Overvoltage controller	0	2		1		607	0 = Not used 1 = Used (no ramping) 2 = Used (ramping)
P1.6.11	Undervoltage controller	0	1		1		608	0 = Not used 1 = Used
P1.6.12	Load Drooping	0.00	100.00		0.00		620	Drooping % of nominal speed at nominal torque
P1.6.13	Identification	0	1		0		631	0 = Not used 1 = V/Hz 2 = V/Hz w/boost

Closed Loop parameter group 1.6.14 (SPX only)

P1.6.14.1	Magnetizing current	0.00	100.00	A	0.00		612	
P1.6.14.2	Speed control P gain	0	1000		30		613	
P1.6.14.3	Speed control I time	0.0	500.0	ms	30.0		614	
P1.6.14.5	Acceleration compensation	0.00	300.00	s	0.00		626	
P1.6.14.6	Slip adjust	0	500	%	100		619	
P1.6.14.7	Magnetizing current at start	MotCurr Min	MotCurr Max	A	0.00		627	
P1.6.14.8	Magnetizing time at start	0.0	600.0	s	0.0		628	
P1.6.14.9	0-speed time at start	0	32000	ms	100		615	
P1.6.14.10	0-speed time at stop	0	32000	ms	100		616	
P1.6.14.11	Start-up torque	0	3		0		621	0 = Not used 1 = Torque memory 2 = Torque reference 3 = Start-up torque fwd/rev
P1.6.14.12	Start-up torque FWD	-300.0	300.0	s	0.0		633	
P1.6.14.13	Start-up torque REV	-300.0	300.0	s	0.0		634	
P1.6.14.15	Encoder filter time	0	1000	ms	0		618	
P1.6.14.17	Current control P gain	0.00	100.00	%	40.00		617	

Local/Remote Control Application

Protections (Control Keypad: Menu M1 → G1.7)

Table 3-9: Protections — G1.7

Code	Parameter	Min.	Max.	Unit	Default	Cust	ID	Note
P1.7.1	Response to reference fault	0	5		0		700	0 = No response 1 = Warning 2 = Warning+Previous Freq. 3 = Wrng+PresetFreq 1.7.2 4 = Fault.stop acc. to 1.4.7 5 = Fault.stop by coasting
P1.7.2	4mA reference fault frequency	0.00	Par. 1.1.2	Hz	0.00		728	
P1.7.3	Response to external fault	0	3		2		701	0 = No response 1 = Warning 2 = Fault.stop acc. to 1.4.7 3 = Fault.stop by coasting
P1.7.4	Input phase supervision	0	3		3		730	
P1.7.5	Response to undervoltage fault	1	3		0		727	
P1.7.6	Output phase supervision	0	3		2		702	
P1.7.7	Earth fault protection	0	3		2		703	
P1.7.8	Thermal protection of the motor	0	3		2		704	
P1.7.9	Motor ambient temperature factor	-100.0	100.0	%	0.0		705	
P1.7.10	Motor cooling factor at zero speed	0.0	150.0	%	40.0		706	
P1.7.11	Motor thermal time constant	1	200	min	45		707	
P1.7.12	Motor duty cycle	0	100	%	100		708	
P1.7.13	Stall protection	0	3		0		709	0 = No response 1 = Warning 2 = Fault.stop acc. to 1.4.7 3 = Fault.stop by coasting

Local/Remote Control Application

Table 3-9: Protections — G1.7 (Continued)

Code	Parameter	Min.	Max.	Unit	Default	Cust	ID	Note
P1.7.14	Stall current	0.1	$I_{nMotor} \times 2$	A	I_L		710	
P1.7.15	Stall time limit	1.00	120.00	s	15.00		711	
P1.7.16	Stall frequency limit	1.0	Par. 1.1.2	Hz	25.0		712	
P1.7.17	Underload protection	0	3		0		713	0 = No response 1 = Warning 2 = Fault.stop acc. to 1.4.7 3 = Fault.stop by coasting
P1.7.18	Field weakening area load	10	150	%	50		714	
P1.7.19	Zero frequency load	5.0	150.0	%	10.0		715	
P1.7.20	Underload protection time limit	2	600	s	20		716	
P1.7.21	Response to thermistor fault	0	3		2		732	0 = No response 1 = Warning 2 = Fault.stop acc. to 1.4.7 3 = Fault.stop by coasting
P1.7.22	Response to fieldbus fault	0	3		2		733	See P1.7.21
P1.7.23	Response to slot fault	0	3		2		734	See P1.7.21
P1.7.24	FB MCW Bit 15	0	2		0		771	0 = No action 1 = Fault low 2 = Fault high

Autorestart Parameters (Control Keypad: Menu M1 → G1.8)

Table 3-10: Autorestart Parameters — G1.8

Code	Parameter	Min.	Max.	Unit	Default	Cust	ID	Note
P1.8.1	Wait time	0.10	10.00	s	0.50		717	
P1.8.2	Trial time	0.00	60.00	s	30.00		718	
P1.8.3	Start function	0	2		0		719	0 = Ramp 1 = Flying start 2 = According to par. 1.4.6
P1.8.4	Number of tries after undervoltage trip	0	10		0		720	
P1.8.5	Number of tries after overvoltage trip	0	10		0		721	
P1.8.6	Number of tries after overcurrent trip	0	3		0		722	
P1.8.7	Number of tries after reference trip	0	10		0		723	

Local/Remote Control Application

Table 3-10: Autorestart Parameters — G1.8 (Continued)

Code	Parameter	Min.	Max.	Unit	Default	Cust	ID	Note
P1.8.8	Number of tries after motor temp fault trip	0	10		0		726	
P1.8.9	Number of tries after external fault trip	0	10		0		725	
P1.8.10	Number of tries after underload fault trip	0	10		0		738	

Keypad Control (Control Keypad: Menu M2)

The parameters for the selection of control place and direction on the keypad are listed below. See the Keypad control menu in the *9000X AF Drives User Manual*.

Table 3-11: Keypad Control Parameters — M2

Code	Parameter	Min.	Max.	Unit	Default	Cust	ID	Note
P2.1	Control place	0	3		3		1685	Used to select Local Remote operation from DIN6 or keypad. 0 = Keypad L/R 1 = Local 2 = Remote 3 = I/O Select
R2.1	Keypad reference	Par. 1.1.1	Par. 1.1.2	Hz				
P2.2	Direction (on keypad)	0	1		0		123	0 = Forward 1 = Reverse
P2.3	Stop button	0	1		1		114	0 = Limited function of Stop button 1 = Stop button always enabled
P2.4	Operate menu hide	0	1		0			0 = No 1 = Yes

System Menu (Control Keypad: Menu M5)

For parameters and functions related to the general use of the drive, such as application and language selection, customized parameter sets or information about the hardware and software, see *Chapter 5* in the *9000X AF Drives User Manual*.

Expander Boards (Control Keypad: Menu M6)

The **M6** menu shows the expander and option boards attached to the control board and board-related information. For more information, see *Chapter 5* in the *9000X AF Drives User Manual*.

Note: Parameter P2.1, Control place, defaults to **3- I/O Select** to disable the Keypad L/R button since Local/Remote selection with this application is normally controlled with Digital Input 6 (DIN6). Select Keypad L/R in parameter P2.1 to enable the Keypad L/R button.

August 2010

Chapter 4 — Multi-Step Speed Control Application

Introduction

Select the Multi-Step Speed Control Application in menu **M5**. See *Chapter 5* of the *9000X AF Drives User Manual*.

The Multi-Step Speed Control Application can be used in applications where fixed speeds are needed. Totally 15 + 2 different speeds can be programmed: one basic speed, 15 multi-step speeds and one jogging speed. The speed steps are selected with digital signals DIN3, DIN4, DIN5 and DIN6. If jogging speed is used, DIN3 can be programmed from fault reset to jogging speed select.

The basic speed reference can be either voltage or current signal via analog input terminals (2/3 or 4/5). The other one of the analog inputs can be programmed for other purposes.

- All outputs are freely programmable.

Additional functions:

- Programmable Start/Stop and Reverse signal logic
- Reference scaling
- One frequency limit supervision
- Second ramps and S-shape ramp programming
- Programmable start and stop functions
- DC-brake at stop
- One skip frequency area
- Programmable U/f curve and switching frequency
- Autorestart
- Motor thermal and stall protection: Programmable action; off, warning, fault

The parameters of the Multi-Step Speed Control Application are explained in **Chapter 8** of this manual. The explanations are arranged according to the individual ID number of the parameter.

Multi-Step Speed Control Application

Control I/O

Table 4-1: Multi-Step Speed Control Application Default I/O Configuration

Terminal	Signal	Description				
OPTA1						
1	+10V _{ref}	Reference output	Voltage for potentiometer, etc.			
2	AI1+	Analog input, voltage range 0 – 10V DC	Basic reference (programmable) range 0 – 10V DC			
3	AI1-	I/O Ground	Ground for reference and controls			
4	AI2+	Analog input, current range 0 – 20 mA	Basic reference (programmable) range 0 – 20 mA			
5	AI2-					
6	+24V	Control voltage output	Voltage for switches, etc. max 0.1A			
7	GND	I/O ground	Ground for reference and controls			
8	DIN1	Start forward (programmable)	Contact closed = start forward			
9	DIN2	Start reverse (programmable)	Contact closed = start reverse			
10	DIN3	External fault input (programmable)	Contact open = no fault Contact closed = fault			
11	CMA	Common for DIN1 – DIN3	Connect to GND or +24V			
12	+24V	Control voltage output	Voltage for switches (see terminal 6)			
13	GND	I/O ground	Ground for reference and controls			
14	DIN4	Multi-step speed select 1	Sel1	Sel2	Sel3	Sel4 (with DIN3)
			0	0	0	0 Basic speed
15	DIN5	Multi-step speed select 2	1	0	0	0 Speed 1
			0	1	0	0 Speed 2
16	DIN6	Multi-step speed select 3
			1	1	1	1 Speed 15
17	CMB	Common for DIN4 – DIN6	Connect to GND or +24V			
18	AO1+	Output frequency Analog output	Programmable Range 0 – 20 mA, R _L , max. 500W			
19	AO1-					
20	DO1	Digital output READY	Programmable Open collector, I ≤ 50 mA, V ≤ 48V DC			
OPTA2						
21	RO1	Relay output 1 RUN	Programmable			
22	RO1					
23	RO1					
24	RO2	Relay output 2 FAULT	Programmable			
25	RO2					
26	RO2					

Note: For more information on jumper selections, see the *9000X AF Drives User Manual, Chapter 4*.

Jumper Block X3: CMA and CMB Grounding

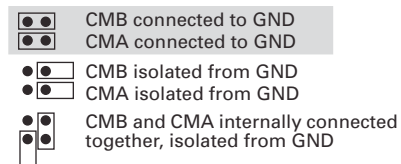

■ = Factory default.

Multi-Step Speed Control Application

Multi-Step Speed Control Application — Parameter Lists

On the next pages you will find the lists of parameters within the respective parameter groups. The parameter descriptions are given in **Chapter 8**.

Column explanations:

Code	=	Location indication on the keypad; Shows the operator the present parameter number
Parameter	=	Name of parameter
Min	=	Minimum value of parameter
Max	=	Maximum value of parameter
Unit	=	Unit of parameter value; Given if available
Default	=	Value preset by factory
Cust	=	Customer's own setting
ID	=	ID number of the parameter
①	=	Parameter value can only be changed after the drive has been stopped.
②	=	Use TTF method to program these parameters. See Page 6-3 .

Monitoring Values (Control Keypad: Menu M7)

The monitoring values are the actual values of parameters and signals as well as statuses and measurements. Monitoring values cannot be edited.

See *9000X AF Drives User Manual, Chapter 5* for more information.

Table 4-2: Monitoring Values

Code	Parameter	Unit	ID	Description
V1.1	Output frequency	Hz	1	Output frequency to motor
V1.2	Frequency reference	Hz	25	Frequency reference to motor control
V1.3	Motor speed	rpm	2	Motor speed in rpm
V1.4	Motor current	A	3	
V1.5	Motor torque	%	4	In % of motor nominal torque
V1.6	Motor power	%	5	Motor shaft power
V1.7	Motor voltage	V	6	
V1.8	DC Bus voltage	V	7	
V1.9	Unit temperature	∞C	8	Heatsink temperature
V1.10	Motor temperature	%	9	Calculated motor temperature
V1.11	Analog input 1	V	13	AI1
V1.12	Analog input 2	mA	14	AI2
V1.13	DIN1, DIN2, DIN3		15	Digital input statuses
V1.14	DIN4, DIN5, DIN6		16	Digital input statuses
V1.15	DO1, RO1, RO2		17	Digital and relay output statuses
V1.16	Analog I _{out}	mA	26	AO1
M1.17	Multimonitoring items			Displays three selectable monitoring values

Multi-Step Speed Control Application

Basic Parameters (Control Keypad: Menu M1 → G1.1)

Table 4-3: Basic Parameters — G1.1

Code	Parameter	Min.	Max.	Unit	Default	Cust	ID	Note
P1.1.1	Min frequency	0.00	Par. 1.1.2	Hz	0.00		101	
P1.1.2	Max frequency	Par. 1.1.1	320.00	Hz	60.00		102	NOTE: If f_{max} > than the motor synchronous speed, check suitability for motor and drive system.
P1.1.3	Acceleration time 1	0.1	3000.0	s	3.0		103	
P1.1.4	Deceleration time 1	0.1	3000.0	s	3.0		104	
P1.1.5	Current limit	$0.4 \times I_H$	$2 \times I_H$	A	I_L		107	
P1.1.6 [Ⓢ]	Nominal voltage of the motor	180	690	V	P: 230V P: 460V P: 575V		110	
P1.1.7 [Ⓢ]	Nominal frequency of the motor	30.00	320.00	Hz	60.00		111	Check the rating plate of the motor.
P1.1.8 [Ⓢ]	Nominal speed of the motor	300	20 000	rpm	1720		112	The default applies for a 4-pole motor and a nominal size frequency converter.
P1.1.9 [Ⓢ]	Nominal current of the motor	$0.4 \times I_H$	$2 \times I_H$	A	I_H		113	Check the rating plate of the motor.
P1.1.10 [Ⓢ]	Power Factor	0.30	1.00		0.85		120	Check the rating plate of the motor.
P1.1.11 [Ⓢ]	Local control place	0	3		1		171	1 = I/O Terminal 2 = Keypad 3 = Fieldbus
P1.1.12 [Ⓢ]	Remote control place	0	3		1		172	1 = I/O Terminal 2 = Keypad 3 = Fieldbus
P1.1.13 [Ⓢ]	Local control reference	0	3		2		173	0 = AI1 1 = AI2 2 = Keypad 3 = Fieldbus
P1.1.14 [Ⓢ]	Remote control reference	0	3		0		174	0 = AI1 1 = AI2 2 = Keypad 3 = Fieldbus
P1.1.15	Motor Id	0	2		0		631	0 = Not user 1 = V/Hz 2 = V/Hz with boost
P1.1.16	V/Hz opt	0	1		0		109	0 = Not used 1 = Automatic torque boost
P1.1.17	Jogging speed pref.	0.00	Par. 1.1.2	Hz	0.00		124	
P1.1.18	Preset speed 1	0.00	Par. 1.1.2	Hz	5.00		105	Multi-step speed 1
P1.1.19	Preset speed 2	0.00	Par. 1.1.2	Hz	10.00		106	Multi-step speed 2
P1.1.20	Preset speed 3	0.00	Par. 1.1.2	Hz	12.50		126	Multi-step speed 3
P1.1.21	Preset speed 4	0.00	Par. 1.1.2	Hz	15.00		127	Multi-step speed 4
P1.1.22	Preset speed 5	0.00	Par. 1.1.2	Hz	17.50		128	Multi-step speed 5
P1.1.23	Preset speed 6	0.00	Par. 1.1.2	Hz	20.00		129	Multi-step speed 6

Multi-Step Speed Control Application

Table 4-3: Basic Parameters — G1.1 (Continued)

Code	Parameter	Min.	Max.	Unit	Default	Cust	ID	Note
P1.1.24	Preset speed 7	0.00	Par. 1.1.2	Hz	22.50		130	Multi-step speed 7
P1.1.25	Preset speed 8	0.00	Par. 1.1.2	Hz	25.00		133	Multi-step speed 8
P1.1.26	Preset speed 9	0.00	Par. 1.1.2	Hz	27.50		134	Multi-step speed 9
P1.1.27	Preset speed 10	0.00	Par. 1.1.2	Hz	30.00		135	Multi-step speed 10
P1.1.28	Preset speed 11	0.00	Par. 1.1.2	Hz	32.50		136	Multi-step speed 11
P1.1.29	Preset speed 12	0.00	Par. 1.1.2	Hz	35.00		137	Multi-step speed 12
P1.1.30	Preset speed 13	0.00	Par. 1.1.2	Hz	40.00		138	Multi-step speed 13
P1.1.31	Preset speed 14	0.00	Par. 1.1.2	Hz	45.00		139	Multi-step speed 14
P1.1.32	Preset speed 15	0.00	Par. 1.1.2	Hz	60.00		140	Multi-step speed 15

Input Signals (Control Keypad: Menu M1 → G1.2)

Table 4-4: Input Signals — G1.2

Code	Parameter	Min.	Max.	Unit	Default	Cust	ID	Note																
P1.2.1 ①	Start/Stop logic	0	6		0		300	<table border="1" style="width: 100%; border-collapse: collapse;"> <thead> <tr> <th style="width: 50%;">DIN1</th> <th style="width: 50%;">DIN2</th> </tr> </thead> <tbody> <tr> <td>0 Start fwd</td> <td>Start rvs</td> </tr> <tr> <td>1 Start/Stop</td> <td>Rvs/Fwd</td> </tr> <tr> <td>2 Start/Stop</td> <td>Run enable</td> </tr> <tr> <td>3 Start pulse</td> <td>Stop pulse</td> </tr> <tr> <td>4 Fwd ③</td> <td>Rvs ③</td> </tr> <tr> <td>5 Start ③/Stop</td> <td>Rvs/Fwd</td> </tr> <tr> <td>6 Start ③/Stop</td> <td>Run enable</td> </tr> </tbody> </table>	DIN1	DIN2	0 Start fwd	Start rvs	1 Start/Stop	Rvs/Fwd	2 Start/Stop	Run enable	3 Start pulse	Stop pulse	4 Fwd ③	Rvs ③	5 Start ③/Stop	Rvs/Fwd	6 Start ③/Stop	Run enable
DIN1	DIN2																							
0 Start fwd	Start rvs																							
1 Start/Stop	Rvs/Fwd																							
2 Start/Stop	Run enable																							
3 Start pulse	Stop pulse																							
4 Fwd ③	Rvs ③																							
5 Start ③/Stop	Rvs/Fwd																							
6 Start ③/Stop	Run enable																							
P1.2.2 ①	DIN3 function	0	12		1		301	0 = Not used 1 = Ext. fault. closing cont. 2 = Ext. fault. opening cont. 3 = Run enable 4 = Acc./Dec. time select. 5 = Force CP to Local ④ 6 = Force CP to Remote ④ 7 = Rvs (if par. 1.2.1 = 3) 8 = Jogging speed 9 = Fault reset 10 = Acc./Dec. operation prohibit 11 = DC Braking command 12 = Preset speed																
P1.2.3 ②	AI1 signal selection	0			A.1		377	TTF programming method used. See Page 6-3 .																
P1.2.4	AI1 signal range	0	2		0		320	0 = 0...100% ③ 1 = 20...100% ③ 2 = Custom setting range ③																

③ Remember to place jumpers of block X2 accordingly. See *9000X AF Drives User Manual, Chapter 4*.

④ CP = control place; cc = closing contact; oc = opening contact.

Multi-Step Speed Control Application

Table 4-4: Input Signals — G1.2 (Continued)

Code	Parameter	Min.	Max.	Unit	Default	Cust	ID	Note
P1.2.5	AI1 custom setting minimum	0.00	100.00	%	0.00		321	Analog input 1 scale minimum
P1.2.6	AI1 custom setting maximum	0.00	100.00	%	100.0		322	Analog input 1 scale maximum
P1.2.7	AI1 signal inversion	0	1		0		323	Analog input 1 reference inversion yes/no
P1.2.8	AI1 signal filter time	0.00	10.00	s	0.10		324	Analog input 1 reference filter time. constant
P1.2.9 ^②	AI2 signal selection	0			A.2		388	TTF programming method used. See Page 6-3 .
P1.2.10	AI2 signal range	0	2		1		325	0 = 0 – 20 mA ^③ 1 = 4 – 20 mA ^③ 2 = custom setting range
P1.2.11	AI2 custom setting minimum	0.00	100.00	%	0.00		326	Analog input 2 scale minimum
P1.2.12	AI2 custom setting maximum	0.00	100.00	%	100.00		327	Analog input 2 scale maximum
P1.2.13	AI2 signal inversion	0	1		0		328	Analog input 2 reference inversion yes/no
P1.2.14	AI2 signal filter time	0.00	10.00	s	0.10		329	Analog input 2 reference filter time, constant
P1.2.15	Reference scaling minimum value	0.00	Par. 1.2.16	Hz	0.00		303	Selects the frequency that corresponds to the min. reference signal
P1.2.16	Reference scaling maximum value	0.00	320.00	Hz	0.00		304	Selects the frequency that corresponds to the max. reference signal 0.00 = No scaling >0 = scaled max. value
P1.2.17	Free analog input signal selection	0	2		0		361	0 = Not used 1 = U_{in} (analog volt. input) 2 = I_{in} (analog curr. input)
P1.2.18	Free analog input function	0	4		0		362	0 = No function 1 = Reduces current limit (par. 1.1.5) 2 = Reduces DC braking current 3 = Reduces accel. and decel. times 4 = Reduces torque supervision limit

^③ Remember to place jumpers of block X2 accordingly. See *9000X AF Drives User Manual, Chapter 4*.

August 2010

Multi-Step Speed Control Application

Output Signals (Control Keypad: Menu M1 → G1.3)

Table 4-5: Output Signals — G1.3

Code	Parameter	Min.	Max.	Unit	Default	Cust	ID	Note
P1.3.1 ^②	AO1 signal selection	0			A.1		464	TTF programming method used. See Page 6-3 .
P1.3.2	Analog output function	0	8		1		307	0 = Not used 1 = Output freq. ($0 - f_{max}$) 2 = Freq. reference ($0 - f_{max}$) 3 = Motor speed ($0 -$ Motor nominal speed) 4 = Motor current ($0 - I_{nMotor}$) 5 = Motor torque ($0 - T_{nMotor}$) 6 = Motor power ($0 - P_{nMotor}$) 7 = Motor voltage ($0 - U_{nMotor}$) 8 = DC-bus volt ($0 - 1000V$)
P1.3.3	Analog output filter time	0.00	10.00	s	1.00		308	0 = No filtering
P1.3.4	Analog output inversion	0	1		0		309	0 = Not inverted 1 = Inverted
P1.3.5	Analog output minimum	0	1		0		310	0 = 0 mA 1 = 4 mA
P1.3.6	Analog output scale	10	1000	%	100		311	
P1.3.7	Digital output 1 function	0	22		1		312	0 = Not used 1 = Ready 2 = Run 3 = Fault 4 = Fault inverted 5 = FC overheat warning 6 = Ext. fault or warning 7 = Ref. fault or warning 8 = Warning 9 = Reversed 10 = Jogging spd selected 11 = At speed 12 = Mot. regulator active 13 = OP freq.limit superv. 1 14 = OP freq.limit superv. 2 15 = Torque limit superv. 16 = Ref. limit superv. 17 = Ext. brake control 18 = Remote Control Active 19 = FC temp. limit superv. 20 = Unrequested rotation direction 21 = Ext. brake control inverted 22 = Thermistor fault/warn.
P1.3.8	Relay output 1 function	0	22		2		313	Same as parameter 1.3.7
P1.3.9	Relay output 2 function	0	22		3		314	Same as parameter 1.3.7
P1.3.10	Output frequency limit 1 supervision	0	2		0		315	0 = No limit 1 = Low limit supervision 2 = High limit supervision

Multi-Step Speed Control Application

Table 4-5: Output Signals — G1.3 (Continued)

Code	Parameter	Min.	Max.	Unit	Default	Cust	ID	Note
P1.3.11	Output frequency limit 1; Supervision value	0.00	320.00	Hz	0.00		316	
P1.3.12	Output frequency limit 2 supervision	0	2		0		346	0 = No limit 1 = Low limit supervision 2 = High limit supervision
P1.3.13	Output frequency limit 2; Supervision value	0.00	320.00	Hz	0.00		347	
P1.3.14	Torque limit supervision function	0	2		0		348	0 = No 1 = Low limit 2 = High limit
P1.3.15	Torque limit supervision value	0.0	200.0	%	0		349	
P1.3.16	Reference limit supervision function	0	2		0		350	0 = No 1 = Low limit 2 = High limit
P1.3.17	Reference limit supervision value	0.0	100.0	%	0.0		351	
P1.3.18	External brake Off-delay	0.0	100.0	s	0.5		352	
P1.3.19	External brake On-delay	0.0	100.0	s	1.5		353	
P1.3.20	Frequency converter temperature limit supervision	0	2		0		354	0 = No 1 = Low limit 2 = High limit
P1.3.21	Frequency converter temperature limit value	-10	75	°C	0		355	
P1.3.22 [Ⓢ]	Analog output 2 signal selection	0			0.1		471	TTF programming method used. See Page 6-3 .
P1.3.23	Analog output 2 function	0	8		4		472	Same as parameter 1.3.2
P1.3.24	Analog output 2 filter time	0.00	10.00	s	1.00		473	0 = No filtering
P1.3.25	Analog output 2 inversion	0	1		0		474	0 = Not inverted 1 = Inverted
P1.3.26	Analog output 2 minimum	0	1		0		475	0 = 0 mA 1 = 4 mA
P1.3.27	Analog output 2 scaling	10	1000	%	100		476	

August 2010

Multi-Step Speed Control Application

Drive Control Parameters (Control Keypad: Menu M1 → G1.4)

Table 4-6: Drive Control Parameters — G1.4

Code	Parameter	Min.	Max.	Unit	Default	Cust	ID	Note
P1.4.1	Ramp 1 shape	0.0	10.0	s	0.0		500	0 = Linear >0 = S-curve ramp time
P1.4.2	Ramp 2 shape	0.0	10.0	s	0.0		501	0 = Linear >0 = S-curve ramp time
P1.4.3	Acceleration time 2	0.1	3000.0	s	10.0		502	
P1.4.4	Deceleration time 2	0.1	3000.0	s	10.0		503	
P1.4.5 [Ⓞ]	Brake chopper	0	4		0		504	0 = Disabled 1 = Used when running 2 = External brake chopper 3 = Used when stopped/running 4 = Used when running (no testing)
P1.4.6	Start function	0	1		0		505	0 = Ramp 1 = Flying start
P1.4.7	Stop function	0	3		1		506	0 = Coasting 1 = Ramp 2 = Ramp+Run enable coast 3 = Coast+Run enable ramp
P1.4.8	DC braking current	0.4 x I _H	2 x I _H	A	I _H		507	
P1.4.9	DC braking time at stop	0.00	600.00	s	0.00		508	0 = DC brake is off at stop
P1.4.10	Frequency to start DC braking during ramp stop	0.10	10.00	Hz	1.50		515	
P1.4.11	DC braking time at start	0.00	600.00	s	0.00		516	0 = DC brake is off at start
P1.4.12	Flux brake	0	1		0		520	0 = Off 1 = On
P1.4.13	Flux braking current	0.4 x I _H	2 x I _H	A	I _H		519	

Skip Frequency Parameters (Control Keypad: Menu M1 → G1.5)

Table 4-7: Skip Frequency Parameters — G1.5

Code	Parameter	Min.	Max.	Unit	Default	Cust	ID	Note
P1.5.1	Skip frequency range 1 low limit	0.00	par. 1.5.2	Hz	0.00		509	
P1.5.2	Skip frequency range 1 high limit	0.00	par. 1.1.2	Hz	0.0		510	0 = Skip frequency range 1 not used
P1.5.3	Skip frequency range 2 low limit	0.00	par. 1.5.2	Hz	0.00		511	
P1.5.4	Skip frequency range 2 high limit	0.00	par. 1.1.2	Hz	0.0		512	0 = Skip frequency range 2 not used
P1.5.5	Skip frequency range 3 low limit	0.00	par. 1.5.2	Hz	0.00		513	
P1.5.6	Skip frequency range 3 high limit	0.00	par. 1.1.2	Hz	0.0		514	0 = Skip frequency range 3 not used
P1.5.7	Skip frequency acc./dec. ramp	0.1	10.0		1.0		518	

Multi-Step Speed Control Application

Motor Control Parameters (Control Keypad: Menu M1 → G1.6)

Table 4-8: Motor Control Parameters — G1.6

Code	Parameter	Min.	Max.	Unit	Default	Cust	ID	Note
P1.6.1 ①	Motor control mode	0	1/6		0		600	SVX: 0 = Frequency control 1 = Speed control Additionally for SPX: 2 = Torque control 3 = Closed loop speed ctrl 4 = Closed loop torque ctrl
P1.6.2 ①	V/Hz optimization	0	1		0		109	0 = Not used 1 = Automatic torque boost
P1.6.3 ①	V/Hzf ratio selection	0	3		0		108	0 = Linear 1 = Squared 2 = Programmable 3 = Linear with flux optim.
P1.6.4 ①	Field weakening point	8.00	320.00	Hz	60.00		602	
P1.6.5 ①	Voltage at field weakening point	10.00	200.00	%	100.00		603	$n\% \times U_{nmot}$
P1.6.6 ①	V/Hz curve midpoint frequency	0.00	Par. 1.6.4	Hz	60.00		604	
P1.6.7 ①	V/Hz curve midpoint voltage	0.00	100.00	%	100.00		605	$n\% \times U_{nmot}$ Parameter max. value = par. 1.6.5
P1.6.8 ①	Output voltage at zero frequency	0.00	40.00	%	1.30		606	$n\% \times U_{nmot}$
P1.6.9	Switching frequency	1.0	Varies	kHz	Varies		601	See Table 8-12 on Page 8-57 for exact values
P1.6.10	Overvoltage controller	0	2		1		607	0 = Not used 1 = Used (no ramping) 2 = Used (ramping)
P1.6.11	Undervoltage controller	0	1		1		608	0 = Not used 1 = Used
P1.6.12	Load Drooping	0.00	100.00		0.00		620	Drooping % of nominal speed at nominal torque
P1.6.13	Identification	0	1		0		631	0 = Not used 1 = V/Hz 2 = V/H w/boost

August 2010

Multi-Step Speed Control Application

Table 4-8: Motor Control Parameters — G1.6 (Continued)

Code	Parameter	Min.	Max.	Unit	Default	Cust	ID	Note
Closed Loop parameter group 1.6.14 (SPX only)								
P1.6.14.1	Magnetizing current	0.00	100.00	A	0.00		612	
P1.6.14.2	Speed control P gain	0	1000		30		613	
P1.6.14.3	Speed control I time	0.0	500.0	ms	30.0		614	
P1.6.14.5	Acceleration compensation	0.00	300.00	s	0.00		626	
P1.6.14.6	Slip adjust	0	500	%	100		619	
P1.6.14.7	Magnetizing current at start	MotCurr Min	MotCurr Max	A	0.00		627	
P1.6.14.8	Magnetizing time at start	0.0	600.0	s	0.0		628	
P1.6.14.9	0-speed time at start	0	32000	ms	100		615	
P1.6.14.10	0-speed time at stop	0	32000	ms	100		616	
P1.6.14.11	Start-up torque	0	3		0		621	0 = Not used 1 = Torque memory 2 = Torque reference 3 = Start-up torque fwd/rev
P1.6.14.12	Start-up torque FWD	-300.0	300.0	s	0.0		633	
P1.6.14.13	Start-up torque REV	-300.0	300.0	s	0.0		634	
P1.6.14.15	Encoder filter time	0	1000	ms	0		618	
P1.6.14.17	Current control P gain	0.00	100.00	%	40.00		617	

Multi-Step Speed Control Application

Protections (Control Keypad: Menu M1 → G1.7)

Table 4-9: Protections — G1.7

Code	Parameter	Min.	Max.	Unit	Default	Cust	ID	Note
P1.7.1	Response to reference fault	0	5		0		700	0 = No response 1 = Warning 2 = Warning+Previous Freq. 3 = Wrng+PresetFreq 1.7.2 4 = Fault.stop acc. to 1.4.7 5 = Fault.stop by coasting
P1.7.2	4mA reference fault frequency	0.00	Par. 1.1.2	Hz	0.00		728	
P1.7.3	Response to external fault	0	3		2		701	0 = No response 1 = Warning 2 = Fault.stop acc. to 1.4.7 3 = Fault.stop by coasting
P1.7.4	Input phase supervision	0	3		3		730	
P1.7.5	Response to undervoltage fault	1	3		0		727	
P1.7.6	Output phase supervision	0	3		2		702	
P1.7.7	Earth fault protection	0	3		2		703	
P1.7.8	Thermal protection of the motor	0	3		2		704	
P1.7.9	Motor ambient temperature factor	-100.0	100.0	%	0.0		705	
P1.7.10	Motor cooling factor at zero speed	0.0	150.0	%	40.0		706	
P1.7.11	Motor thermal time constant	1	200	min	45		707	
P1.7.12	Motor duty cycle	0	100	%	100		708	
P1.7.13	Stall protection	0	3		0		709	0 = No response 1 = Warning 2 = Fault.stop acc. to 1.4.7 3 = Fault.stop by coasting
P1.7.14	Stall current	0.1	$I_{nMotor} \times 2$	A	I_L		710	
P1.7.15	Stall time limit	1.00	120.00	s	15.00		711	
P1.7.16	Stall frequency limit	1.0	Par. 1.1.2	Hz	25.0		712	
P1.7.17	Underload protection	0	3		0		713	0 = No response 1 = Warning 2 = Fault.stop acc. to 1.4.7 3 = Fault.stop by coasting
P1.7.18	Field weakening area load	10	150	%	50		714	
P1.7.19	Zero frequency load	5.0	150.0	%	10.0		715	
P1.7.20	Underload protection time limit	2	600	s	20		716	
P1.7.21	Response to thermistor fault	0	3		2		732	0 = No response 1 = Warning 2 = Fault.stop acc. to 1.4.7 3 = Fault.stop by coasting
P1.7.22	Response to fieldbus fault	0	3		2		733	See P1.7.21
P1.7.23	Response to slot fault	0	3		2		734	See P1.7.21

August 2010

Multi-Step Speed Control Application

Autorestart Parameters (Control Keypad: Menu M1 → G1.8)

Table 4-10: Autorestart Parameters — G1.8

Code	Parameter	Min.	Max.	Unit	Default	Cust	ID	Note
P1.8.1	Wait time	0.10	10.00	s	0.50		717	
P1.8.2	Trial time	0.00	60.00	s	30.00		718	
P1.8.3	Start function	0	2		0		719	0 = Ramp 1 = Flying start 2 = According to par. 1.4.6
P1.8.4	Number of tries after undervoltage trip	0	10		0		720	
P1.8.5	Number of tries after overvoltage trip	0	10		0		721	
P1.8.6	Number of tries after overcurrent trip	0	3		0		722	
P1.8.7	Number of tries after reference trip	0	10		0		723	
P1.8.8	Number of tries after motor temp fault trip	0	10		0		726	
P1.8.9	Number of tries after external fault trip	0	10		0		725	
P1.8.10	Number of tries after underload fault trip	0	10		1		738	

Keypad Control (Control Keypad: Menu M2)

The parameters for the selection of control place and direction on the keypad are listed below. See the Keypad control menu in the *9000X AF Drives User Manual*.

Table 4-11: Keypad Control Parameters — M2

Code	Parameter	Min.	Max.	Unit	Default	Cust	ID	Note
P2.1	Control place	0	3		0		1685	0 = Keypad L/R 1 = Local 2 = Remote 3 = I/O force
R2.1	Keypad reference	Par. 1.1.1	Par. 1.1.2	Hz				
P2.3	Direction (on keypad)	0	1		0		123	0 = Forward 1 = Reverse
P2.4	Stop button	0	1		1		114	0 = Limited function of Stop button 1 = Stop button always enabled
P2.5	Operate menu hide	0	1		0		1688	0 = No 1 = Yes

System Menu (Control Keypad: Menu M5)

For parameters and functions related to the general use of the drive, such as application and language selection, customized parameter sets or information about the hardware and software, see *Chapter 5* in the *9000X AF Drives User Manual*.

Expander Boards (Control Keypad: Menu M6)

The **M6** menu shows the expander and option boards attached to the control board and board-related information. For more information, see *Chapter 5* in the *9000X AF Drives User Manual*.

August 2010

Chapter 5 — PID Control Application

Introduction

Select the PID Control Application in menu **M5**. See *Chapter 5* of the *9000X AF Drives User Manual*.

In the PID Control Application, there are two I/O terminal control places; place A is the PID controller and source B is the direct frequency reference. The control place A or B is selected with digital input DIN6.

The PID controller reference can be selected from the analog inputs, fieldbus, motorized potentiometer, enabling the PID Reference 2 or applying the control keypad reference. The PID controller actual value can be selected from the analog inputs, fieldbus, the actual values of the motor or through the mathematical functions of these.

The direct frequency reference can be used for the control without the PID controller and selected from the analog inputs, fieldbus, motor potentiometer or keypad.

The PID Application is typically used to control level measuring or pumps and fans. In these applications, the PID Application provides a smooth control and an integrated measuring and controlling package where no additional components are needed.

- Digital inputs DIN2, DIN3, DIN5 and all the outputs are freely programmable.

Additional functions:

- Analog input signal range selection
- Two frequency limit supervisions
- Torque limit supervision
- Reference limit supervision
- Second ramps and S-shape ramp programming
- Programmable start and stop functions
- DC-brake at start and stop
- Three skip frequency areas
- Programmable U/f curve and switching frequency
- Autostart
- Motor thermal and stall protection: fully programmable; off, warning, fault
- Motor underload protection
- Input and output phase supervision
- Sum point frequency addition to PID output
- The PID controller can additionally be used from control places I/O B, keypad and fieldbus
- Easy ChangeOver function
- Sleep function

The parameters of the PID Control Application are explained in **Chapter 8** of this manual. The explanations are arranged according to the individual ID number of the parameter.

PID Control Application

Control I/O

Table 5-1: PID Application Default I/O Configuration (with 2-wire transmitter)

Terminal	Signal	Description
OPTA1		
1	+10V _{ref}	Reference output Voltage for potentiometer, etc.
2	AI1+	Analog input, voltage range 0 – 10V DC Voltage input frequency reference
3	AI1-	I/O Ground Ground for reference and controls
4	AI2+	Analog input, current range 0 – 20 mA Current input frequency reference
5	AI2-	
6	+24V	Control voltage output Voltage for switches, etc. max 0.1A
7	GND	I/O ground Ground for reference and controls
8	DIN1	Start/Stop Control place A (PID controller) Contact closed = fault Contact open = no fault
9	DIN2	External fault input (programmable) Contact closed = fault Contact open = no fault
10	DIN3	Fault reset (programmable) Contact closed = fault reset
11	CMA	Common for DIN1 – DIN3 Connect to GND or +24V
12	+24V	Control voltage output Voltage for switches (see #6)
13	GND	I/O ground Ground for reference and controls
14	DIN4	Start/Stop Control place B (Direct frequency reference) Contact closed = Start
15	DIN5	Jogging speed selection (programmable) Contact closed = Jogging speed active
16	DIN6	Control place A/B selection Contact open = Control place A is active Contact closed = Control place B is active
17	CMB	Common for DIN4 – DIN6 Connect to GND or +24V
18	AO1+	Output frequency Analog output Programmable Range 0 – 20 mA/R _L , max. 500W
19	AO1-	
20	DO1	Digital output READY Programmable Open collector, I ≤ 50 mA, U ≤ 48V DC
OPTA2		
21	RO1	Relay output 1 RUN
22	RO1	
23	RO1	
24	RO2	Relay output 2 FAULT
25	RO2	
26	RO2	

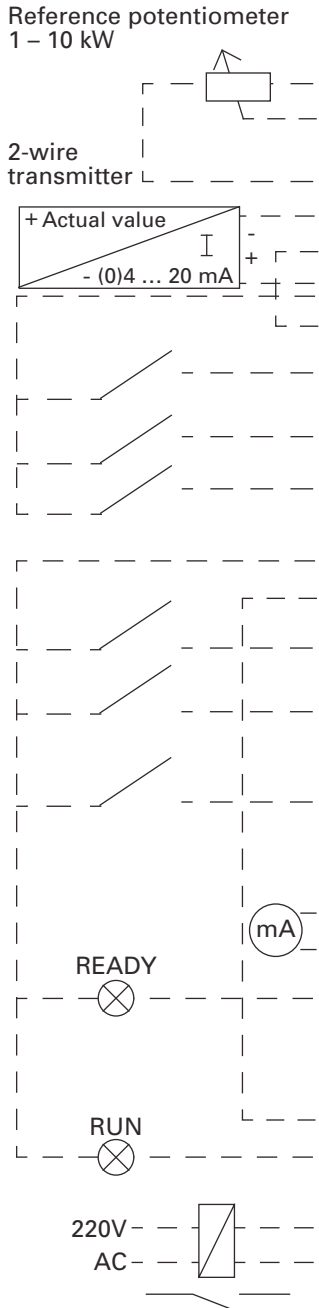

Note: For more information on jumper selections, see the *9000X AF Drives User Manual, Chapter 4. Jumper Block X3: CMA and CMB Grounding*

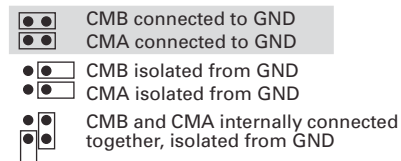

■ = Factory default.

PID Control Application

PID Control Application — Parameter Lists

On the next pages you will find the lists of parameters within the respective parameter groups. The parameter descriptions are given in **Chapter 8**.

Column explanations:

- Code = Location indication on the keypad; Shows the operator the present parameter number
- Parameter = Name of parameter
- Min = Minimum value of parameter
- Max = Maximum value of parameter
- Unit = Unit of parameter value; Given if available
- Default = Value preset by factory
- Cust = Customer's own setting
- ID = ID number of the parameter
- ① = Parameter value can only be changed after the drive has been stopped.
- ② = Use TTF method to program these parameters. See **Page 6-3**.

Monitoring Values (Control Keypad: Menu M7)

The monitoring values are the actual values of parameters and signals as well as statuses and measurements. Monitoring values cannot be edited.

See *9000X AF Drives User Manual, Chapter 5* for more information. Note that the monitoring values V1.19 to V1.22 are available with the PID control application only.

Table 5-2: Monitoring Values

Code	Parameter	Unit	ID	Description
V1.1	Output frequency	Hz	1	Output frequency to motor
V1.2	Frequency reference	Hz	25	Frequency reference to motor control
V1.3	Motor speed	rpm	2	Motor speed in rpm
V1.4	Motor current	A	3	
V1.5	Motor torque	%	4	In % of Motor nom. torque
V1.6	Motor power	%	5	Motor shaft power
V1.7	Motor voltage	V	6	
V1.8	DC Bus voltage	V	7	
V1.9	Unit temperature	∞C	8	Heatsink temperature
V1.10	Motor temperature	%	9	Calculated motor temperature
V1.11	Analog input 1	V	13	AI1
V1.12	Analog input 2	mA	14	AI2
V1.13	Analog input 3		27	AI3
V1.14	Analog input 4		28	AI4
V1.15	DIN1, DIN2, DIN3		15	Digital input statuses

PID Control Application

Table 5-2: Monitoring Values (Continued)

Code	Parameter	Unit	ID	Description
V1.16	DIN4, DIN5, DIN6		16	Digital input statuses
V1.17	DO1, RO1, RO2		17	Digital and relay output statuses
V1.18	Analog I _{out}	mA	26	AO1
V1.19	PID Reference	%	20	In % of the max. frequency
V1.20	PID Actual value	%	21	In % of the max. actual value
V1.21	PID Error value	%	22	In % of the max. error value
V1.22	PID Output	%	23	In % of the max. output value
V1.23	PT-100 Temperature	C°		Highest temperature of used inputs
G1.24	Monitoring items			Displays three selectable monitoring values

Basic Parameters (Control Keypad: Menu M1 → G1.1)

Table 5-3: Basic Parameters — G1.1

Code	Parameter	Min.	Max.	Unit	Default	Cust	ID	Note
P1.1.1	Min frequency	0.00	Par. 1.1.2	Hz	0.00		101	
P1.1.2	Max frequency	Par. 1.1.1	320.00	Hz	60.00		102	NOTE: If f_{max} > than the motor synchronous speed. check suitability for motor and drive system
P1.1.3	Acceleration time 1	0.1	3000.0	s	1.0		103	NOTE: If PID-controller is used, Acceleration time 2 (par. 1.4.3) is automatically applied
P1.1.4	Deceleration time 1	0.1	3000.0	s	1.0		104	NOTE: If PID-controller is used, Deceleration time 2 (par. 1.4.4) is automatically applied
P1.1.5	Current limit	$0.1 \times I_H$	$2 \times I_H$	A	I_L		107	
P1.1.6 ①	Nominal voltage of the motor	180	690	V	P: 230V P: 460V P: 575V		110	
P1.1.7 ①	Nominal frequency of the motor	30.00	320.00	Hz	60.00		111	Check the rating plate of the motor
P1.1.8 ①	Nominal speed of the motor	300	20 000	rpm	1720		112	The default applies for a 4-pole motor and a nominal size frequency converter.
P1.1.9 ①	Nominal current of the motor	$0.1 \times I_H$	$2 \times I_H$	A	I_H		113	Check the rating plate of the motor.
P1.1.10 ①	Power Factor	0.30	1.00		0.85		120	Check the rating plate of the motor
P1.1.11 ①	Local control place	0	3		2		171	1 = I/O Terminal 2 = Keypad 3 = Fieldbus
P1.1.12 ①	Remote control place	0	3		1		172	1 = I/O Terminal 2 = Keypad 3 = Fieldbus

August 2010

PID Control Application

Table 5-3: Basic Parameters — G1.1 (Continued)

Code	Parameter	Min.	Max.	Unit	Default	Cust	ID	Note
P1.1.13 ①	Local control reference	0	3		4		173	0 = AI1 1 = AI2 2 = AI3 3 = AI4 4 = Keypad reference 5 = Fieldbus reference (FBSpeedReference) 6 = Motor potentiometer 7 = PID controller
P1.1.14 ①	Remotes control reference	0	3		0		174	0 = AI1 1 = AI2 2 = AI3 3 = AI4 4 = Keypad reference 5 = Fieldbus reference (FBSpeedReference) 6 = Motor potentiometer 7 = PID controller
P1.1.15	Motor Id	0	2		0		631	0 = Not used 1 = V/Hz 2 = V/Hz with boost
P1.1.16	V/Hz opt	0	1		0		109	0 = Not used 1 = Automatic torque boost
P1.1.17 ①	PID controller reference signal (Place A)	0	4		2		332	0 = Anal.volt. input (#2 – 3) 1 = Anal.curr.input (#4 – 5) 2 = PID ref from Keypad control page, par. 3.4 3 = PID ref from fieldbus (ProcessDataIN 1) 4 = Motor potentiometer
P1.1.18	PID controller gain	0.0	1000.0	%	100.0		118	
P1.1.19	PID controller I-time	0.00	320.00	s	1.00		119	
P1.1.20	PID controller D-time	0.00	100.00	s	0.00		132	
P1.1.21	Sleep frequency	Par. 1.1.1	Par. 1.1.2	Hz	10.00		1016	
P1.1.22	Sleep delay	0	3600	s	30		1017	
P1.1.23	Wake up level	0.00	100.00	%	25.00		1018	
P1.1.24	Wake up function	0	1		0		1019	0 = Wake-up at fall below wake up level (1.1.17) 1 = Wake-up at exceeded wake up level (1.1.17)
P1.1.25	Jogging speed reference	0.00	Par. 1.1.1	Hz	10.00		124	

PID Control Application

Input Signals (Control Keypad: Menu M1 → G1.2)

Table 5-4: Input Signals — G1.2

Code	Parameter	Min.	Max.	Unit	Default	Cust	ID	Note
P1.2.1 ^③	DIN2 function	0	13		1		319	0 = Not used 1 = External fault (cc) ^③ 2 = External fault (oc) ^③ 3 = Run enable 4 = Acc/Dec time selection 5 = Force Local 6 = Not used 7 = Force Remote 8 = Forward/Reverse 9 = Jogging frequency (cc) ^③ 10 = Fault reset (cc) ^③ 11 = Acc/Dec prohibit (cc) ^③ 12 = DC braking command 13 = Motor pot. UP (cc) ^③
P1.2.2 ^③	DIN3 function	0	13		10		301	See above except: 12 = Motor pot. DOWN (cc) ^③
P1.2.3 ^③	DIN5 function	0	13		9		330	See above except: 12 = Enable PID reference 2
P1.2.4 ^③	PID sum point reference	0	7		0		376	0 = None 1 = AI1+PID output 2 = AI2+PID output 3 = AI3+PID output 4 = AI4+PID output 5 = PID keypad+PID output 6 = Fieldbus+PID output (ProcessDataIN3) 7 = Mot.pot.+PID output
P1.2.5 ^③	Actual value selection	0	7		0		333	0 = Actual value 1 1 = Actual 1 + Actual 2 2 = Actual 1 – Actual 2 3 = Actual 1 * Actual 2 4 = Max (Actual 1, Actual 2) 5 = Min (Actual 1, Actual 2) 6 = Mean (Actual 1, Actual 2) 7 = Sqrt (Act1) + Sqrt (Act2)
P1.2.6 ^③	Actual value 1 selection	0	10		2		334	0 = Not used 1 = AI1 signal (c-board) 2 = AI2 signal (c-board) 3 = AI3 4 = AI4 5 = Fieldbus (ProcessDataIN2) 6 = Motor torque 7 = Motor speed 8 = Motor current 9 = Motor power 10 = Encoder frequency

^③ CP = control place; cc = closing contact; oc = opening contact.

August 2010

PID Control Application

Table 5-4: Input Signals — G1.2 (Continued)

Code	Parameter	Min.	Max.	Unit	Default	Cust	ID	Note
P1.2.7 ^①	Actual value 2 input	0	9		0		335	0 = Not used 1 = AI1 signal (c-board) 2 = AI2 signal (c-board) 3 = AI3 4 = AI4 5 = Fieldbus (ProcessDataIN3) 6 = Motor torque 7 = Motor speed 8 = Motor current 9 = Motor power
P1.2.8	Actual value 1 minimum scale	-1000.0	1000.0	%	0.0		336	0 = No minimum scaling
P1.2.9	Actual value 1 maximum scale	-1000.0	1000.0	%	100.0		337	100 = No maximum scaling
P1.2.10	Actual value 2 minimum scale	-1000.0	1000.0	%	0.0		338	0 = No minimum scaling
P1.2.11	Actual value 2 maximum scale	-1000.0	1000.0	%	100.0		339	100 = No maximum scaling
P1.2.12 ^②	AI1 signal selection	0			A.1		377	TTF programming method used. See Page 6-3 .
P1.2.13	AI1 signal range	0	2		0		320	0 = Signal range 0 – 100% ^③ 1 = Signal range 20 – 100% ^③ 2 = Custom range ^②
P1.2.14	AI1 custom minimum setting	0.00	100.00	%	0.00		321	
P1.2.15	AI1 custom maximum setting	0.00	100.00	%	100.00		322	
P1.2.16	AI1 inversion	0	1		0		323	0 = Not inverted 1 = Inverted
P1.2.17	AI1 filter time	0.00	10.00	s	0.10		324	0 = No filtering
P1.2.18 ^②	AI2 signal selection	0			A.2		388	TTF programming method used. See Page 6-3 .
P1.2.19	AI2 signal range	0	2		1		325	0 = 0 – 20 mA ^③ 1 = 4 – 20 mA ^③ 2 = Customized ^③
P1.2.20	AI2 custom minimum setting	0.00	100.00	%	0.00		326	
P1.2.21	AI2 custom maximum setting	0.00	100.00	%	100.00		327	
P1.2.22	AI2 inversion	0	1		0		328	0 = Not inverted 1 = Inverted
P1.2.23	AI2 filter time	0.00	10.00	s	0.10		329	0 = No filtering
P1.2.24	Motor potentiometer ramp time	0.1	2000.0	/s	10.0		331	

^③ Remember to place jumpers of block X2 accordingly. See *9000X AF Drives User Manual, Chapter 4*.

PID Control Application

Table 5-4: Input Signals — G1.2 (Continued)

Code	Parameter	Min.	Max.	Unit	Default	Cust	ID	Note
P1.2.25	Motor potentiometer frequency reference memory reset	0	2		1		367	0 = No reset 1 = Reset if stopped or powered down 2 = Reset if powered down
P1.2.26	Motor potentiometer PID reference memory reset	0	2		0		370	0 = No reset 1 = Reset if stopped or powered down 2 = Reset if powered down
P1.2.27	PID minimum limit	-1000.0	Par. 1.2.29	%	0.00		359	
P1.2.28	PID maximum limit	Par. 1.2.28	1000.0	%	100.00		360	
P1.2.29	Error value inversion	0	1		0		340	0 = No inversion 1 = Inversion
P1.2.30	PID reference rising time	0.0	100.0	s	5.0		341	
P1.2.31	PID reference falling time	0.0	100.0	s	5.0		342	
P1.2.32	Reference scaling minimum value, place B	0.00	Par. 1.2.34	Hz	0.00		344	
P1.2.33	Reference scaling maximum value, place B	Par. 1.2.33	320.00	Hz	0.00		345	
P1.2.34 ②	AI3 signal selection	0			0.1		141	TTF programming method used. See Page 6-3 .
P1.2.35	AI3 signal range	0	1		1		143	0 = 0 – 10V 1 = 4mA/20%–100%
P1.2.36 ②	AI3 inversion	0	1		0		151	0 = Not inverted 1 = Inverted
P1.2.37	AI3 filter time	0.00	10.00	s	0.10		142	0 = No filtering
P1.2.38	AI4 signal selection	0			0.1		152	TTF programming method used. See Page 6-3 .
P1.2.39	AI4 signal range	0	1		1		154	0 = 0 – 10V 1 = 4mA/20%–100%
P1.2.40	AI4 inversion	0	1		0		162	0 = Not inverted 1 = Inverted
P1.2.41	AI4 filter time	0.00	10.00	s	0.10		153	0 = No filtering

PID Control Application

Output Signals (Control Keypad: Menu M1 → G1.3)

Table 5-5: Output Signals — G1.3

Code	Parameter	Min.	Max.	Unit	Default	Cust	ID	Note
P1.3.1 ②	Analog output 1 signal selection	0			A.1		464	TTF programming method used. See Page 6-3 .
P1.3.2	Analog output function	0	14		1		307	0 = Not used 1 = Output freq. ($0 - f_{max}$) 2 = Freq. reference ($0 - f_{max}$) 3 = Motor speed ($0 - \text{Motor nominal speed}$) 4 = Motor current ($0 - I_{nMotor}$) 5 = Motor torque ($0 - T_{nMotor}$) 6 = Motor power ($0 - P_{nMotor}$) 7 = Motor voltage ($0 - U_{nMotor}$) 8 = DC-Bus volt ($0 - 1000V$) 9 = PID controller ref. value 10 = PID contr. act. value 1 11 = PID contr. act. value 2 12 = PID contr. error value 13 = PID controller output 14 = PT100 temperature
P1.3.3	Analog output filter time	0.00	10.00	s	1.00		308	0 = No filtering
P1.3.4	Analog output inversion	0	1		0		309	0 = Not inverted 1 = Inverted
P1.3.5	Analog output minimum	0	1		0		310	0 = 0 mA 1 = 4 mA
P1.3.6	Analog output scale	10	1000	%	100		311	
P1.3.7	Digital output 1 function	0	23		1		312	0 = Not used 1 = Ready 2 = Run 3 = Fault 4 = Fault inverted 5 = FC overheat warning 6 = Ext. fault or warning 7 = Ref. fault or warning 8 = Warning 9 = Reversed 10 = Preset speed 1 11 = At speed 12 = Mot. regulator active 13 = OP freq. limit superv.1 14 = OP freq. limit superv.2 15 = Torque limit superv. 16 = Ref. limit supervision 17 = External brake control 18 = Remote Control Active 19 = FC temp. limit superv. 20 = Unrequested direction 21 = Ext. brake control inv. 22 = Thermistor fault/warn. 23 = Fieldbus input data
P1.3.8	Relay output 1 function	0	23		2		313	Same as parameter 1.3.7

PID Control Application

Table 5-5: Output Signals — G1.3 (Continued)

Code	Parameter	Min.	Max.	Unit	Default	Cust	ID	Note
P1.3.9	Relay output 2 function	0	23		3		314	Same as parameter 1.3.7
P1.3.10	Output frequency limit 1 supervision	0	2		0		315	0 = No limit 1 = Low limit supervision 2 = High limit supervision
P1.3.11	Output frequency limit 1; Supervised value	0.00	Par. 1.1.2	Hz	0.00		316	
P1.3.12	Output frequency limit 2 supervision	0	2		0		346	0 = No limit 1 = Low limit supervision 2 = High limit supervision
P1.3.13	Output frequency limit 2; Supervised value	0.00	Par. 1.1.2	Hz	0.00		347	
P1.3.14	Torque limit supervision	0	2		0		348	0 = Not used 1 = Low limit supervision 2 = High limit supervision
P1.3.15	Torque limit supervision value	0.0	300.0	%	100.0		349	
P1.3.16	Reference limit supervision	0	2		0		350	0 = Not used 1 = Low limit 2 = High limit
P1.3.17	Reference limit supervision value	0.00	Par. 1.1.2	Hz	0.00		351	
P1.3.18	External brake-off delay	0.0	100.0	s	0.5		352	
P1.3.19	External brake-on delay	0.0	100.0	s	1.5		353	
P1.3.20	FC temperature supervision	0	2		0		354	0 = Not used 1 = Low limit 2 = High limit
P1.3.21	FC temperature supervised value	-10	75	°C	40		355	
P1.3.22 [Ⓢ]	Analog output 2 signal selection	0			0.1		471	TTF programming method used. See Page 6-3 .
P1.3.23	Analog output 2 function	0	13		4		472	Same as parameter 1.3.2
P1.3.24	Analog output 2 filter time	0.00	10.00	s	1.00		473	0 = No filtering
P1.3.25	Analog output 2 inversion	0	1		0		474	0 = Not inverted 1 = Inverted
P1.3.26	Analog output 2 minimum	0	1		0		475	0 = 0 mA 1 = 4 mA
P1.3.27	Analog output 2 scaling	10	1000	%	100		476	

PID Control Application

Drive Control Parameters (Control Keypad: Menu M1 → G1.4)

Table 5-6: Drive Control Parameters — G1.4

Code	Parameter	Min.	Max.	Unit	Default	Cust	ID	Note
P1.4.1	Ramp 1 shape	0.0	10.0	s	0.0		500	0 = Linear >0 = S-curve ramp time
P1.4.2	Ramp 2 shape	0.0	10.0	s	0.0		501	0 = Linear >0 = S-curve ramp time
P1.4.3	Acceleration time 2	0.1	3000.0	s	0.1		502	
P1.4.4	Deceleration time 2	0.1	3000.0	s	0.1		503	
P1.4.5 [Ⓢ]	Brake chopper	0	4		0		504	0 = Not used 1 = Used when running 2 = External brake chopper 3 = Used when stopped/running 4 = Used when running (no testing)
P1.4.6	Start function	0	1		0		505	0 = Ramp 1 = Flying start
P1.4.7	Stop function	0	3		1		506	0 = Coasting 1 = Ramp 2 = Ramp+Run enable coast 3 = Coast+Run enable ramp
P1.4.8	DC braking current	0.4 x I _H	2 x I _H	A	I _H		507	
P1.4.9	DC braking time at stop	0.00	600.00	s	0.00		508	0 = DC brake is off at stop
P14.10	Frequency to start DC braking during ramp stop	0.10	10.00	Hz	1.50		515	
P1.4.11	DC braking time at start	0.00	600.00	s	0.00		516	0 = DC brake is off at start
P1.4.12	Flux brake	0	1		0		520	0 = Off 1 = On
P1.4.13	Flux braking current	0.4 x I _H	2 x I _H	A	I _H		519	

Skip Frequency Parameters (Control Keypad: Menu M1 → G1.5)

Table 5-7: Skip Frequency Parameters — G1.5

Code	Parameter	Min.	Max.	Unit	Default	Cust	ID	Note
P1.5.1	Skip frequency range 1 low limit	0.00	par. 1.5.2	Hz	0.00		509	
P1.5.2	Skip frequency range 1 high limit	0.00	par. 1.1.2	Hz	0.0		510	0 = Skip frequency range 1 not used
P1.5.3	Skip frequency range 2 low limit	0.00	par. 1.5.2	Hz	0.00		511	
P1.5.4	Skip frequency range 2 high limit	0.00	par. 1.1.2	Hz	0.0		512	0 = Skip frequency range 2 not used
P1.5.5	Skip frequency range 3 low limit	0.00	par. 1.5.2	Hz	0.00		513	
P1.5.6	Skip frequency range 3 high limit	0.00	par. 1.1.2	Hz	0.0		514	0 = Skip frequency range 3 not used
P1.5.7	Skip frequency acc./dec. ramp	0.1	10.0		1.0		518	

PID Control Application

Motor Control Parameters (Control Keypad: Menu M1 → G1.6)

Table 5-8: Motor Control Parameters — G1.6

Code	Parameter	Min.	Max.	Unit	Default	Cust	ID	Note
P1.6.1 ①	Motor control mode	0	1/6		0		600	SVX: 0 = Frequency control 1 = Speed control Additionally for SPX: 2 = Torque control 3 = Closed loop speed ctrl 4 = Closed loop torque ctrl
P1.6.2 ①	V/Hz optimization	0	1		0		109	0 = Not used 1 = Automatic torque boost
P1.6.3 ①	V/Hz ratio selection	0	3		0		108	0 = Linear 1 = Squared 2 = Programmable 3 = Linear with flux optim.
P1.6.4 ①	Field weakening point	8.00	320.00	Hz	60.00		602	
P1.6.5 ①	Voltage at field weakening point	10.00	200.00	%	100.00		603	$n\% \times U_{nmot}$
P1.6.6 ①	V/Hz curve midpoint frequency	0.00	Par. 1.6.4	Hz	60.00		604	V/Hz midfreq
P1.6.7 ①	V/Hz curve midpoint voltage	0.00	100.00	%	100.00		605	$n\% \times U_{nmot}$ Parameter max. value = par. 1.6.5
P1.6.8 ①	Output voltage at zero frequency	0.00	40.00	%	1.30		606	$n\% \times U_{nmot}$
P1.6.9	Switching frequency	1.0	Varies	kHz	Varies		601	See Table 8-12 on Page 8-57 for exact values
P1.6.10 ①	Overvoltage controller	0	2		1		607	0 = Not used 1 = Used (no ramping) 2 = Used (ramping)
P1.6.11	Undervoltage controller	0	1		1		608	0 = Not used 1 = Used
P1.6.12	Load Drooping	0.00	100.00		0.00		620	Drooping % of nominal speed at nominal torque
P1.6.13	Identification	0	1		0		631	0 = Not used 1 = Used

August 2010

PID Control Application

Table 5-8: Motor Control Parameters — G1.6 (Continued)

Code	Parameter	Min.	Max.	Unit	Default	Cust	ID	Note
Closed Loop parameter group 1.6.14 (SPX only)								
P1.6.14.1	Magnetizing current	0.00	100.00	A	0.00		612	
P1.6.14.2	Speed control P gain	0	1000		30		613	
P1.6.14.3	Speed control I time	0.0	500.0	ms	30.0		614	
P1.6.14.4	Load drooping	0.00	100.00	%	0.00		620	
P1.6.14.5	Acceleration compensation	0.00	300.00	s	0.00		626	
P1.6.14.6	Slip adjust	0	500	%	100		619	
P1.6.14.7	Magnetizing current at start	MotCurr Min	MotCurr Max	A	0.00		627	
P1.6.14.8	Magnetizing time at start	0.0	600.0	s	0.0		628	
P1.6.14.9	0-speed time at start	0	32000	ms	100		615	
P1.6.14.10	0-speed time at stop	0	32000	ms	100		616	
P1.6.14.11	Start-up torque	0	3		0		621	0 = Not used 1 = Torque memory 2 = Torque reference 3 = Start-up torque fwd/rev
P1.6.14.12	Start-up torque FWD	-300.0	300.0	s	0.0		633	
P1.6.14.13	Start-up torque REV	-300.0	300.0	s	0.0		634	
P1.6.14.15	Encoder filter time	0	1000	ms	0		618	
P1.6.14.17	Current control P gain	0.00	100.00	%	40.00		617	

PID Control Application

Protections (Control Keypad: Menu M1 → G1.7)

Table 5-9: Protections — G1.7

Code	Parameter	Min.	Max.	Unit	Default	Cust	ID	Note
P1.7.1	Response to reference fault	0	5		0		700	0 = No response 1 = Warning 2 = Warning+Previous Freq. 3 = Wrng+PresetFreq 1.7.2 4 = Fault.stop acc. to 1.4.7 5 = Fault.stop by coasting
P1.7.2	4mA reference fault frequency	0.00	Par. 1.1.2	Hz	0.00		728	
P1.7.3	Response to external fault	0	3		2		701	0 = No response 1 = Warning
P1.7.4	Input phase supervision	0	3		3		730	2 = Fault.stop acc. to 1.4.7 3 = Fault.stop by coasting
P1.7.5	Response to undervoltage fault	1	3		0		727	
P1.7.6	Output phase supervision	0	3		2		702	
P1.7.7	Earth fault protection	0	3		2		703	
P1.7.8	Thermal protection of the motor	0	3		2		704	
P1.7.9	Motor ambient temperature factor	-100.0	100.0	%	0.0		705	
P1.7.10	Motor cooling factor at zero speed	0.0	150.0	%	40.0		706	
P1.7.11	Motor thermal time constant	1	200	min	45		707	
P1.7.12	Motor duty cycle	0	100	%	100		708	
P1.7.13	Stall protection	0	3		1		709	0 = No response 1 = Warning 2 = Fault.stop acc. to 1.4.7 3 = Fault.stop by coasting
P1.7.14	Stall current	0.1	$I_{nMotor} \times 2$	A	I_L		710	
P1.7.15	Stall time limit	1.00	120.00	s	15.00		711	
P1.7.16	Stall frequency limit	1.0	Par. 1.1.2	Hz	25.0		712	
P1.7.17	Underload protection	0	3		0		713	0 = No response 1 = Warning 2 = Fault.stop acc. to 1.4.7 3 = Fault.stop by coasting
P1.7.18	Field weakening area load	10	150	%	50		714	
P1.7.19	Zero frequency load	5.0	150.0	%	10.0		715	
P1.7.20	Underload protection time limit	2	600	s	20		716	

PID Control Application

Protections — G1.7 (Continued)

Code	Parameter	Min.	Max.	Unit	Default	Cust	ID	Note
P1.7.21	Response to thermistor fault	0	3		2		732	0 = No response 1 = Warning 2 = Fault.stop acc. to 1.4.7 3 = Fault.stop by coasting
P1.7.22	Response to fieldbus fault	0	3		2		733	See P1.7.21
P1.7.23	Response to slot fault	0	3		2		734	See P1.7.21
P1.7.24	No. of PT100 inputs	0	3		0		739	
P1.7.25	Response to PT100 fault	0	3		2		740	0 = No response 1 = Warning 2 = Fault.stop acc. to 1.4.7 3 = Fault.stop by coasting
P1.7.26	PT100 warning limit	-30.0	200.0	C°	120.0		741	
P1.7.27	PT100 fault limit	-30.0	200.0	C°	130.0		742	

Autorestart Parameters (Control Keypad: Menu M1 → G1.8)

Table 5-10: Autorestart Parameters — G1.8

Code	Parameter	Min.	Max.	Unit	Default	Cust	ID	Note
P1.8.1	Wait time	0.10	10.00	s	0.50		717	
P1.8.2	Trial time	0.00	60.00	s	30.00		718	
P1.8.3	Start function	0	2		0		719	0 = Ramp 1 = Flying start 2 = According to par. 1.4.6
P1.8.4	Number of tries after undervoltage trip	0	10		0		720	
P1.8.5	Number of tries after overvoltage trip	0	10		0		721	
P1.8.6	Number of tries after overcurrent trip	0	3		0		722	
P1.8.7	Number of tries after reference trip	0	10		0		723	
P1.8.8	Number of tries after motor temp fault trip	0	10		0		726	
P1.8.9	Number of tries after external fault trip	0	10		0		725	
P1.8.10	Number of tries after underload fault trip	0	10		0		738	

PID Control Application

Keypad Control (Control Keypad: Menu M2)

The parameters for the selection of control place and direction on the keypad are listed below. See the Keypad control menu in the *9000X AF Drives User Manual*.

Table 5-11: Keypad Control Parameters — M2

Code	Parameter	Min.	Max.	Unit	Default	Cust	ID	Note
P2.1	Control place	0	3		0		1685	0 = Keypad L/R 1 = Local 2 = Remote 3 = I/O force
R2.2	Keypad reference	Par. 1.1.1	Par.1.1.2	Hz				
P2.3	Direction (on keypad)	0	1		0		123	0 = Forward 1 = Reverse
R2.4	PID reference	0.00	100.00	%	50.00			
R2.5	PID reference 2	0.00	100.00	%	0.00			
P2.6	Stop button	0	1		1		114	0 = Limited function of Stop button 1 = Stop button always enabled
P2.7	Operate menu hide	0	1	1				0 = Yes 1 = No

System Menu (Control Keypad: Menu M5)

For parameters and functions related to the general use of the drive, such as application and language selection, customized parameter sets or information about the hardware and software, see *Chapter 5* in the *9000X AF Drives User Manual*.

Expander Boards (Control Keypad: Menu M6)

The **M6** menu shows the expander and option boards attached to the control board and board-related information. For more information, see *Chapter 5* in the *9000X AF Drives User Manual*.

Note: In local and remote control, the control mode is determined by DIN6 unless the PID is selected as the reference.

August 2010

Chapter 6 — Multi-Purpose Control Application

Introduction

Select the Multi-Purpose Control Application in menu **M5**. See *Chapter 5* of the *9000X AF Drives User Manual*.

Multi-purpose control application provides a wide range of parameters for controlling motors. It can be used for various kinds of different processes, where wide flexibility of I/O signals is needed and PID-control is not necessary (if you need PID-control functions, use PID-control Application or Pump and Fan Control Application).

The frequency reference can be selected e.g. from the analog inputs, joystick control, motor potentiometer and from a mathematical function of the analog inputs. There are parameters also for Fieldbus communication. Multi-step speeds and jogging speed can also be selected if digital inputs are programmed for these functions.

- The digital inputs and all the outputs are freely programmable and the application supports all I/O-boards

Additional functions:

- Analog input signal range selection
- Two frequency limit supervisions
- Torque limit supervision
- Reference limit supervision
- Second ramps and S-shape ramp programming
- Programmable Start/Stop and Reverse logic
- DC-brake at start and stop
- Three skip frequency areas
- Programmable V/Hz curve and switching frequency
- Autorestart
- Motor thermal and stall protection: fully programmable; off, warning, fault
- Motor underload protection
- Input and output phase supervision
- Joystick hysteresis
- Possibility to connect the FB Process data to any parameter and some monitoring values

The parameters of the Multi-Purpose Control Application are explained in **Chapter 8** of this manual. The explanations are arranged according to the individual ID number of the parameter.

Multi-Purpose Control Application

Control I/O

Table 6-1: Multi-Purpose Control Application Default I/O Configuration and Connection Example

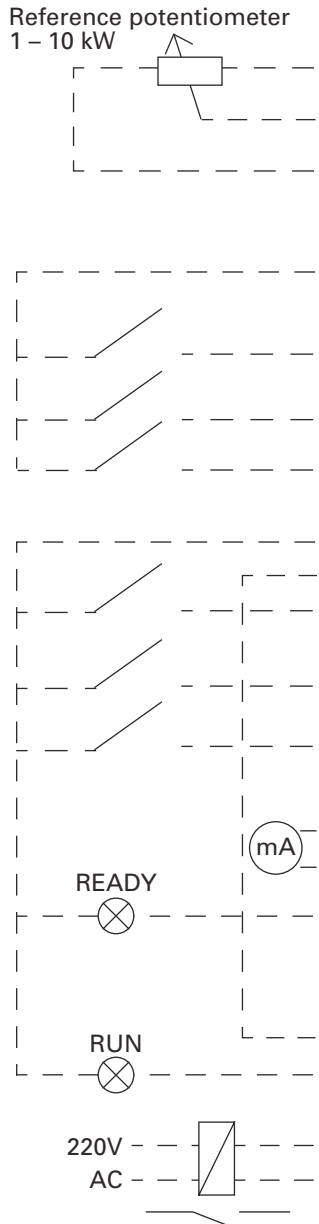

Terminal	Signal	Description
OPTA1		
1	+10V _{ref}	Reference output Voltage for potentiometer, etc.
2	AI1+	Analog input, voltage range 0 – 10V DC Voltage input frequency reference
3	AI1-	I/O Ground Ground for reference and controls
4	AI2+	Analog input, current range 0 – 20 mA Current input frequency reference
5	AI2-	
6	+24V	Control voltage output Voltage for switches, etc. max 0.1A
7	GND	I/O ground Ground for reference and controls
8	DIN1	Start forward (programmable) Contact closed = start forward
9	DIN2	Start reverse (programmable) Contact closed = start reverse
10	DIN3	Fault reset (programmable) Contact closed = fault reset
11	CMA	Common for DIN1 – DIN3 Connect to GND or +24V
12	+24V	Control voltage output Voltage for switches (see terminal 6)
13	GND	I/O ground Ground for reference and controls
14	DIN4	Jog speed selection (programmable) Contact closed = jog speed active
15	DIN5	External fault (programmable) Contact open = no fault Contact closed = fault
16	DIN6	Accel./decel. time select (programmable) Contact open = P1.1.3, P1.1.4 in use Contact closed = P1.4.3, P1.4.4 in use
17	CMB	Common for DIN4 – DIN6 Connect to GND or +24V
18	AOA1+	Output frequency Analog output Programmable Range 0 – 20 mA, R _L , max. 500W
19	AOA1-	
20	DOA1	Digital output READY Programmable Open collector, I ≤ 50 mA, V ≤ 48V DC
OPTA2		
21	RO1	Relay output 1 RUN Programmable
22	RO1	
23	RO1	
24	RO2	Relay output 2 FAULT Programmable
25	RO2	
26	RO2	

Note: For more information on jumper selections, see the *9000X AF Drives User Manual, Chapter 4.*

Jumper Block X3: CMA and CMB Grounding

- CMA connected to GND
- CMB connected to GND
- CMA isolated from GND
- CMB isolated from GND
- CMA and CMB internally connected together, isolated from GND

= Factory default.

August 2010

Multi-Purpose Control Application

“Terminal To Function” (TTF) Programming Principle

The programming principle of the input and output signals in the **Multi-Purpose Control Application** as well as in the **Pump and Fan Control Application** (and partly in the other applications) is different compared to the conventional method used in other SVX applications.

In the conventional programming method, *Function To Terminal programming method (FTT)*, you have a fixed input or output that you define a certain function for. The applications mentioned above, however, use the *Terminal To Function programming method (TTF)* in which the programming process is carried out the other way round: Functions appear as parameters which the operator defines a certain input/output. See *Caution* on **Page 6-4**.

Defining an Input/Output for a Certain Function on Keypad

Connecting a certain input or output with a certain function (parameter) is done by giving the parameter an appropriate value. The value is formed of the *Board slot* on the SVX control board (see *9000X AF Drives User Manual, Chapter 4*) and the *respective signal number* as shown in **Figure 6-1**.

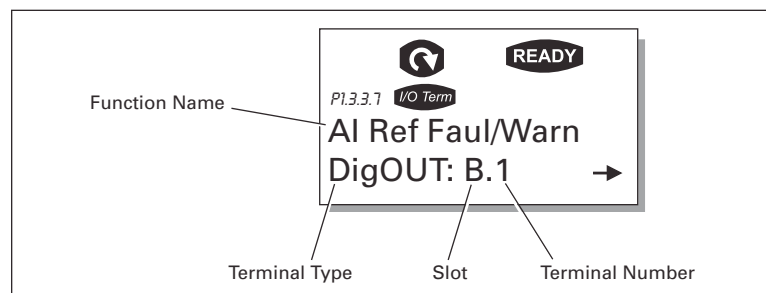

Figure 6-1: Defining Input/Output — Function

Example: You want to connect the digital output function *Reference fault/warning* (P1.3.3.7) to the digital output DO1 on the basic board OPTA1 (see *9000X AF Drives User Manual, Chapter 4*).

First find the P1.3.3.7 on the keypad. Press the *Menu button right* once to enter the edit mode. On the *value line*, you will see the terminal type on the left (DigIN, DigOUT, An.IN, An.OUT) and on the right, the present input/output the function is connected to (B.3, A.2 etc.), or if not connected, a value (0.#).

When the value is blinking, hold down the *Browser button up* or *down* to find the desired board slot and signal number. The program will scroll the board slots starting from **0** and proceeding from **A** to **E** and the I/O selection from **1** to **10**.

Once you have set the desired value, press the *Enter button* once to confirm the change. See **Figure 6-2**.



Figure 6-2: Defining Input/Output — Values

Multi-Purpose Control Application

Defining a Terminal for a Certain Function with 9000X Drive Programming Tool

If you use the 9000X Drive Programming Tool for parametrizing you will have to establish the connection between the function and input/output in the same way as with the control panel. Just pick the address code from the drop-down menu in the *Value* column (see **Figure 6-3**).

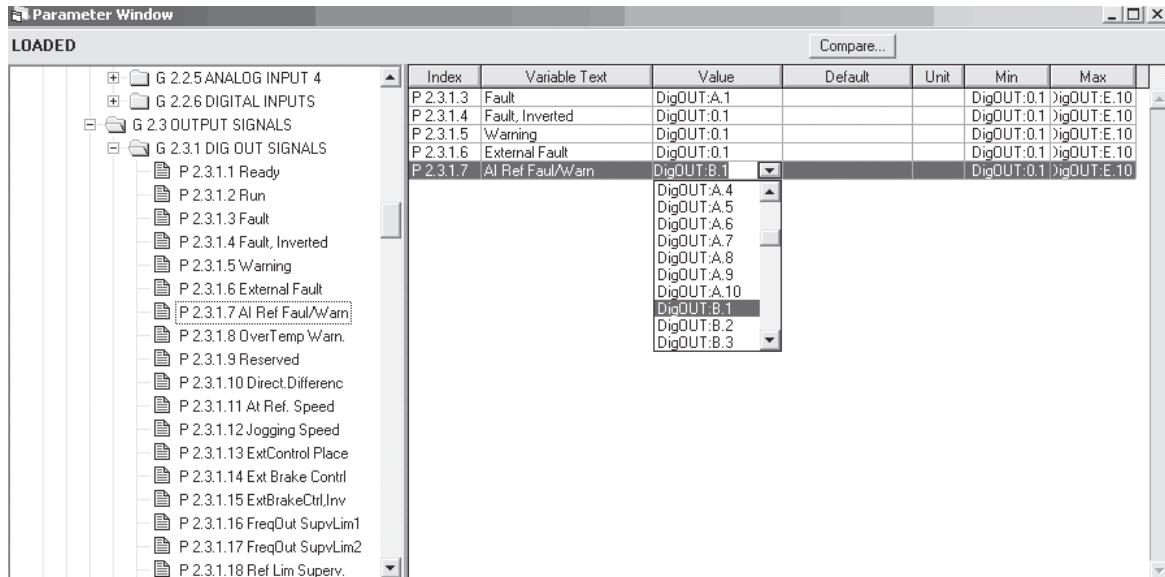

Figure 6-3: Screenshot of 9000X Drive Programming Tool; Entering the Address Code

CAUTION

Be **ABSOLUTELY** sure not to connect two functions to one and same output in order to avoid function overruns and to ensure flawless operation.

Notice

The *inputs*, unlike the *outputs*, cannot be changed in RUN state.

Defining Unused Inputs/Outputs

All unused inputs and outputs must be given the board slot value **0** and the value **1** also for the terminal number. The value **0.0** is also the default value for most of the functions. However, if you want to use the **values of a digital input signal** for e.g. testing purposes only, you can set the board slot value to **0** and the terminal number to any number between 2...10 to place the input to a TRUE state. In other words, the value 1 corresponds to "open contact" and values 2 to 10 to closed contact.

In case of analog inputs, giving the value **1** for the terminal number corresponds to 0%, value **2** corresponds to 20% and any value between **3** and **10** corresponds to 100%.

August 2010

Multi-Purpose Control Application

Parameter Lists

On the next pages you will find the lists of parameters within the respective parameter groups. The parameter descriptions are given in **Chapter 8**.

Column explanations:

Code	=	Location indication on the keypad; Shows the operator the present parameter number
Parameter	=	Name of parameter
Min.	=	Minimum value of parameter
Max.	=	Maximum value of parameter
Unit	=	Unit of parameter value; Given if available
Default	=	Value preset by factory
Cust	=	User's customized setting
ID	=	ID number of the parameter for reference to Chapter 8
①	=	Parameter value can only be changed when the drive is stopped
②	=	Programmed using <i>terminal to function</i> (TTF) method. See Page 6-3 .

Monitoring Values (Control Keypad: Menu M8)

The monitoring values are the actual values of parameters and signals as well as statuses and measurements. Monitoring values cannot be edited.

See *9000X AF Drives User Manual, Chapter 5* for more information.

Table 6-2: Monitoring Values, SPX Drives

Code	Parameter	Unit	ID	Description
V7.1	Output Frequency	Hz	1	Output frequency to motor
V7.2	FreqReference	Hz	25	Frequency reference to motor control
V7.3	Motor Speed Rpm	rpm	2	Motor speed in rpm
V7.4	Motor Current	A	3	
V7.5	Motor Torque	%	4	In % of nominal torque
V7.6	Motor Power	%	5	Motor shaft power in %
V7.7	Motor Voltage	V	6	
V7.8	DC-Bus Voltage	V	7	
V7.9	Unit Temperature	∞C	8	Heatsink temperature
V7.10	MotorTemperature	%	9	Calculated motor temperature
V7.11	Analog Input 1	V	13	AI1
V7.12	Analog Input 2	mA	14	AI2
V7.13	DIN1, DIN2, DIN3		15	Digital input status
V7.14	DIN4, DIN5, DIN6		16	Digital input status
V7.15	Analog Iout	mA	26	AO1
V7.16	Analog Input 3	mA	27	AI3
V7.17	Analog Input 4	mA	14	AI4
V7.18	Torque Reference	%	18	
V7.19	PT100 Temp.	C°	42	Max PT100 Temp

Multi-Purpose Control Application

Table 6-2: Monitoring Values, SPX Drives (Continued)

Code	Parameter	Unit	ID	Description
M7.20	Multimonitor			Displays three selectable monitor values
G7.21	Monitor 2			
V7.21.1	Current	A	1113	Unfiltered Motor Current
V7.21.2	Torque	%	1125	Unfiltered Motor Torque
V7.21.3	DC Voltage	V	44	Unfiltered DC Link Voltage
V7.21.4	Status Word		43	Application Status Word
V7.21.5	Last Active Fault		37	
V7.21.6	On Time Hours	h	10	Power On Trip Counter
V7.21.7	DIN Status Word		56	DIN 1–6 (Low b) and OPT-B1 or B9 DIN (High b)
V7.21.8	Motor Current FB	A	45	Motor current to 1 decimal place
V7.21.9	U Phase Current	A	39	
V7.21.10	V Phase Current	A	40	
V7.21.11	W Phase Current	A	41	
V7.21.12	PT100 Temp. In1	°C	50	
V7.21.13	PT100 Tem. In2	°C	51	
V7.21.14	PT100 Tem. In3	°C	52	
V7.21.15	PT100 Tem. In4	°C	69	
V7.21.16	PT100 Tem. In5	°C	70	
V7.21.17	PT100 Tem. In6	°C	71	

Operate Menu-M8

The Operate Menu provides an easy-to-use method of viewing key numerical Monitoring Menu Items. It also allows the setting of the Keypad frequency or torque reference. See Chapter 5 of the 9000X User Manual for more information.

Table 6-3: Operate Menu Items

Code	Parameter	Unit	Description
O1	Output Frequency	Hz	Output frequency to motor
O2	FreqReference	Hz	Frequency reference to motor control
O3	Motor Speed	rpm	Motor speed in rpm
O4	Motor Current	A	
O5	Motor Torque	%	In % of nominal motor torque
O6	Motor Power	%	Motor shaft power in %
O7	Motor Voltage	V	
O8	DC-Bus Voltage	V	
O9	Unit Temperature	°C	Heatsink temperature
O10	MotorTemperature	%	Calculated motor temperature
O11	U Phase Current	A	Motor phase current
O12	V Phase Current	A	Motor phase current
O13	W Phase Current	A	Motor phase current
O14	Torque Reference	%	Torque Ref in Torque Control Mode
R1	Keypad Reference	Hz	Set keypad frequency reference
R4	Torque Reference	Hz	Set keypad torque reference

August 2010

Multi-Purpose Control Application

Fieldbus Control and Status

The Multipurpose Application has more functionality with the fieldbus control. Bits 3 through 7 of the Fixed Control Word can be used to set digital outputs. The digital inputs are monitored with the DIN Status Word (ID 56). The mode of the control is monitored with the Application Status Word (ID 43), Bits 4, 8, 9, and 10.

Table 6-4: Fixed Control Word

Bit	Function	Note
B0	FB_Run	
B1	FB_Reverse	
B2	FB_Fault_Reset	
B3	FB_D01	See Parameter 1.3.3.24
B4	FB_D02	See Parameter 1.3.3.25
B5	FB_D03	See Parameter 1.3.3.26
B6	FB_D04	See Parameter 1.3.3.27
B7	FB_D05	See Parameter 1.3.3.28
B8	Not Used	
B9	Not Used	
B10	Not Used	
B11	FB_WD_Pulse	See Parameter 1.7.32
B12	Not Used	
B13	Not Used	
B14	Not Used	
B15	FB_Fault_Monitor (internal)	Select Comm cards

Table 6-5: Status Word

Code	General Status Word	Application Status Word
B0	MC_Ready	Not used
B1	MC_Run	MC_Ready
B2	MC_Reverse	MC_Run
B3	MC_Fault	MC_Fault
B4	MC_Warning	FB_Ref_Active
B5	MC_AtSpeed	Not used
B6	MC_ZeroSpeed	RunEnable
B7	MC_FluxReady	MC_Warning
B8	MC_TCSpeedLimit Active	Panel I/O Control Indicator
B9	MC_DetectedEncoderDirection	Panel Panel Control Indicator
B10	MC_UVFastStop	Panel Fieldbus Control Indicator
B11	MC_DC_Brake	MC_DC_Brake
B12	FB_Ref_Active	RunRequest
B13	MC_StartDelay (not used)	Motor Regulator Status not Zero
B14	Remote_Active	External Brake Control
B15	FB_WD_Pulse	Not used

Multi-Purpose Control Application

Basic Parameters (Control Keypad: Menu M1 → G1.1)

Table 6-6: Basic Parameters — G1.1

Code	Parameter	Min.	Max.	Unit	Default	ID	Note
P1.1.1	Min frequency	0.00	Par. 1.1.2	Hz	0.00	101	
P1.1.2	Max frequency	Par. 1.1.1	320.00	Hz	60.00	102	NOTE: If f_{max} > than the motor synchronous speed, check suitability for motor and drive system.
P1.1.3	Acceleration time 1	0.1	3000.0	s	3.0	103	
P1.1.4	Deceleration time 1	0.1	3000.0	s	3.0	104	
P1.1.5	Current limit	$0.1 \times I_H$	$2 \times I_H$	A	I_L	107	I_H is the nominal current rating of the 9000X inverter.
P1.1.6 ①	Nominal voltage of the motor	180	690	V	SVX-2: 230V SVX-4: 460V SVX-5: 575V	110	Motor nameplate value.
P1.1.7 ①	Nominal frequency of the motor	0.00	320.00	Hz	60.00	111	Motor nameplate value.
P1.1.8 ①	Nominal speed of the motor	0	65000	rpm	1720	112	Motor nameplate value.
P1.1.9 ①	Nominal current of the motor	$0.1 \times I_H$	$2 \times I_H$	A	I_H	113	Check the rating plate of the motor.
P1.1.10	Power Factor	0.30	1.00		0.85	120	Check the rating plate of the motor.
P1.1.11	Local control place	1	3		2	171	1 = I/O Terminal 2 = Keypad 3 = Fieldbus
P1.1.12	Remote control place	1	3		1	172	1 = I/O Terminal 2 = Keypad 3 = Fieldbus
P1.1.13	Local reference	0	15		8	173	0 = AI1 1 = AI2 2 = AI1+AI2 3 = AI1-AI2 4 = AI2-AI1 5 = AI1xAI2 6 = AI1 Joystick 7 = AI2 Joystick 8 = Keypad 9 = Fieldbus 10 = Motor potentiometer 11 = AI1, AI2 minimum 12 = AI1, AI2 maximum 13 = Max frequency 14 = AI1/AI2 selection 15 = Encoder A1

Multi-Purpose Control Application

Table 6-6: Basic Parameters — G1.1 (Continued)

Code	Parameter	Min.	Max.	Unit	Default	ID	Note
P1.1.14	Remote reference	0	15		0/AI1	174	See par. 1.1.13
P1.1.15	Identification	0	1/2		0/No Action	631	0 = No Action 1 = ID No Run SPX Only 2 = ID With Run
P1.1.16	V/Hz Boost	0	1		0/None	109	0 = None 1 = AutoTorqBoos
P1.1.17	Jog Speed Ref	Min Freq	Max Freq	Hz	5.00	124	
P1.1.18	Preset Speed 1	Min Freq	Max Freq	Hz	10.00	105	
P1.1.19	Preset Speed 2	Min Freq	Max Freq	Hz	15.00	106	
P1.1.20	Preset Speed 3	Min Freq	Max Freq	Hz	20.00	126	
P1.1.21	Preset Speed 4	Min Freq	Max Freq	Hz	25.00	127	
P1.1.22	Preset Speed 5	Min Freq	Max Freq	Hz	30.00	128	
P1.1.23	Preset Speed 6	Min Freq	Max Freq	Hz	40.00	129	
P1.1.24	Preset Speed 7	Min Freq	Max Freq	Hz	60.00	130	

Input Signals

Basic Settings (Control Keypad: Menu M1 → G1.2.1)

Table 6-7: Input Signals: Basic Settings — G1.2.1

Code	Parameter	Min.	Max.	Unit	Default	ID	Note
P1.2.1.1 ①	Start/Stop logic selection	0	7		0	300	0 = Forw-Rev 1 = Start-Rev 2 = Start-Enable 3 = StartP-StopP 4 = Strt-MotP UP 5 = ForwR-RevR 6 = StartR-Rev 7 = StrtR-Enable
P1.2.1.2 ①	MotPot ramp time	0.1	2000.0	Hz/s	10.0	331	
P1.2.1.3 ①	MotPotMemFreqRef	0	2		1	367	0 = No reset 1 = Res: stop+P.D. 2 = Res: P.D.
P1.2.1.4 ①	Adjust input	0	5		0	493	0 = Not used 1 = AI1 2 = AI2 3 = AI3 4 = AI4 5 = Fieldbus
P1.2.1.5	Adjust minimum	0.0	100.0	%	0.0	494	
P1.2.1.6	Adjust maximum	0.0	100.0	%	0.0	495	

Multi-Purpose Control Application

Analog Input 1 (Control Keypad: Menu M1 → G1.2.2)

Table 6-8: Analog Input 1 Parameters — G1.2.2

Code	Parameter	Min.	Max.	Unit	Default	ID	Note
P1.2.2.1 ^②	AI1 signal selection	0			A.1	377	TTF programming. See chapter 6.3
P1.2.2.2	AI1 filter time	0.00	10.00	s	0.10	324	0 = No filtering
P1.2.2.3	AI1 signal range	0	3		0	320	0 = 0–100% 1 = 4mA/20%–100% 2 = -10V...+10V 3 = Custom range ^③
P1.2.2.4	AI1 custom minimum setting	-160.00	160.00	%	0.00	321	
P1.2.2.5	AI1 custom maximum setting	-160.00	160.00	%	100.00	322	
P1.2.2.6	AI1 reference scaling. minimum value	0.00	320.00	Hz	0.00	303	Selects the frequency that corresponds to the min. reference signal
P1.2.2.7	AI1 reference scaling. maximum value	0.00	320.00	Hz	0.00		304
P1.2.2.8	AI1 joystick hysteresis	0.00	20.00	%	0.00		384
P1.2.2.9	AI1 sleep limit	0.00	100.00	%	0.00		385
P1.2.2.10	AI1 sleep delay	0.00	320.00	s	0.00		386
P1.2.2.11	AI1 joystick offset	-50.00	50.00	%	0.00		165

^③ Remember to place jumpers of block X2 accordingly. See *9000X AF Drives User Manual, Chapter 4*.

August 2010

Multi-Purpose Control Application

Analog Input 2 (Control Keypad: Menu M1 → G1.2.3)

Table 6-9: Analog Input 2 Parameters — G1.2.3

Code	Parameter	Min.	Max.	Unit	Default	Cust	ID	Note
P1.2.3.1 ^②	AI2 signal selection	0			A.2		388	TTF programming. See chapter 6.3
P1.2.3.2	AI2 filter time	0.00	10.00	s	0.10		329	0 = No filtering
P1.2.3.3	AI2 signal range	0	3		1		325	0 = 0–100% 1 = 4mA/20%–100% 2 = -10V...+10V ^③ 3 = Custom range ^③
P1.2.3.4	AI2 custom minimum setting	-160.00	160.00	%	0.00		326	
P1.2.3.5	AI2 custom maximum setting	-160.00	160.00	%	100.00		327	
P1.2.3.6	AI2 reference scaling, minimum value	0.00	320.00	Hz	0.00		393	Selects the frequency that corresponds to the min. reference signal
P1.2.3.7	AI2 reference scaling, maximum value	0.00	320.00	Hz	0.00		394	Selects the frequency that corresponds to the max. reference signal
P1.2.3.8	AI2 joystick hysteresis	0.00	20.00	%	0.00		395	Dead zone for joystick input
P1.2.3.9	AI2 sleep limit	0.00	100.00	%	0.00		396	Drive goes to sleep mode if input is below this limit for set time.
P1.2.3.10	AI2 sleep delay	0.00	320.00	s	0.00		397	
P1.2.3.11	AI2 joystick offset	-50.00	50.00	%	0.00		166	

^③ Remember to place jumpers of block X2 accordingly. See *9000X AF Drives User Manual, Chapter 4*.

Analog Input 3 (Control Keypad: Menu M1 → G1.2.4)

Table 6-10: Analog Input 3 Parameters — G1.2.4

Code	Parameter	Min.	Max.	Unit	Default	Cust	ID	Note
P1.2.4.1 ^②	AI3 signal selection	0			0.1		141	TTF programming. See chapter 6.3
P1.2.4.2	AI3 filter time	0.00	10.00	s	0.10		142	0 = No filtering
P1.2.4.3	AI3 signal range	0	3		1		143	0 = 0–100% 1 = 4mA/20%–100% 2 = -10V...+10V 3 = Custom range
P1.2.4.4	AI3 custom minimum setting	-160.00	160.00	%	0.00		144	
P1.2.4.5	AI3 custom maximum setting	-160.00	160.00	%	100.00		145	
P1.2.4.6	AI3 signal inversion	0	1		0		151	0 = Not inverted 1 = Inverted

Multi-Purpose Control Application

Analog Input 4 (Control Keypad: Menu M1 → G1.2.5)

Table 6-11: Analog Input 4 Parameters — G1.2.5

Code	Parameter	Min.	Max.	Unit	Default	Cust	ID	Note
P1.2.5.1 ②	AI4 signal selection	0			0.1		152	
P1.2.5.2	AI4 filter time	0.00	10.00	s	0.10		153	0 = No filtering
P1.2.5.3	AI4 signal range	0	3		1		154	0 = 0–100% 1 = 4mA/20%–100% 2 = -10V...+10V 3 = Custom range
P1.2.5.4	AI4 custom minimum setting	-160.00	160.00	%	0.00		155	
P1.2.5.5	AI4 custom maximum setting	-160.00	160.00	%	100.00		156	
P1.2.5.6	AI4 signal inversion	0	1		0		162	0 = Not inverted 1 = Inverted

Free Analog Input Signal Selection (Keypad: Menu M1 → G1.2.6)

Table 6-12: Free Analog Input Signal Selection — G1.2.6

Code	Parameter	Min.	Max.	Unit	Default	Cust	ID	Note
P1.2.6.1	Scaling of current limit	0	5		0		399	0 = Not used 1 = AI1 2 = AI2 3 = AI3 4 = AI4 5 = Fieldbus (FBProcessDataIN2)
P1.2.6.2	Scaling of DC-braking current	0	5		0		400	See par. 1.2.6.1
P1.2.6.3	Reducing of acc./dec. times	0	5		0		401	See par. 1.2.6.1
P1.2.6.4	Reducing of torque supervision limit	0	5		0		402	See par. 1.2.6.1
P1.2.6.5	Torque limit	0	5		0		485	See par. 1.2.6.1

August 2010

Multi-Purpose Control Application

Digital Inputs (Control Keypad: Menu M1 → G1.2.7)

Table 6-13: Digital Input Signals — G1.2.7

Code	Parameter	Min.	Max	Default	ID	Note
P1.2.7.1 ②	Start Signal 1	DigIN:0.1	DigIN:E.10	DigIN:A.1	403	See P1.2.1.1
P1.2.7.2 ②	Start signal 2	DigIN:0.1	DigIN:E.10	DigIN:A.2	404	See P1.2.1.1
P1.2.7.3 ②	Run Enable	DigIN:0.1	DigIN:E.10	DigIN:0.2	407	Motor start enabled (cc) ③
P1.2.7.4 ②	Reverse	DigIN:0.1	DigIN:E.10	DigIN:0.1	412	Direction forward (oc) ③ Direction reverse (cc) ③
P1.2.7.5 ②	Preset Speed 1	DigIN:0.1	DigIN:E.10	DigIN:0.1	419	See preset speeds in Basic Parameters (G2.1)
P1.2.7.6 ②	Preset Speed 2	DigIN:0.1	DigIN:E.10	DigIN:0.1	420	
P1.2.7.7 ②	Preset Speed 3	DigIN:0.1	DigIN:E.10	DigIN:0.1	421	
P1.2.7.8 ②	Mot Pot Down	DigIN:0.1	DigIN:E.10	DigIN:0.1	417	Mot.pot. reference decreases (cc) ③
P1.2.7.9 ②	Mot Pot Up	DigIN:0.1	DigIN:E.10	DigIN:0.1	418	Mot.pot. reference increases (cc) ③
P1.2.7.10 ②	Fault Reset	DigIN:0.1	DigIN:E.10	DigIN:A.3	414	All faults reset (cc) ③
P1.2.7.11 ②	External Fault (close)	DigIN:0.1	DigIN:E.10	DigIN:A.5	405	Ext. fault (F51) displayed (cc) ③
P1.2.7.12 ②	External Fault (open)	DigIN:0.1	DigIN:E.10	DigIN:0.2	406	Ext. fault (F51) displayed (oc) ③
P1.2.7.13 ②	Acc/Dec Time Sel	DigIN:0.1	DigIN:E.10	DigIN:A.6	408	Acc/Dec time 1 (oc) ③ Acc/Dec time 2 (cc) ③
P1.2.7.14 ②	Acc/Dec Prohibit	DigIN:0.1	DigIN:E.10	DigIN:0.1	415	Acc/Dec prohibited (cc) ③
P1.2.7.15 ②	DC Brake Command	DigIN:0.1	DigIN:E.10	DigIN:0.1	416	DC braking active (cc) ③
P1.2.7.16 ②	Jogging Speed	DigIN:0.1	DigIN:E.10	DigIN:A.4	413	Jogging speed selected for frequency reference (cc) ③
P1.2.7.17 ②	AI1/AI2 Select	DigIN:0.1	DigIN:E.10	DigIN:0.1	422	cc = AI2 is used as reference, when ID117 = 14
P1.2.7.18 ②	Force Remote	DigIN:0.1	DigIN:E.10	DigIN:0.1	409	Force control place to Remote (cc) ③
P1.2.7.19 ②	Parameter Set1/Set2 Sel	DigIN:0.1	DigIN:E.10	DigIN:0.1	496	Closed cont. = Set 2 is used Open cont. = Set 1 is used
P1.2.7.20 ②	Motor Ctrl Mode 1/2	DigIN:0.1	DigIN:E.10	DigIN:0.1	164	Closed cont. = Mode 2 is used Open cont. = Mode 1 is used
P1.2.7.21	CPX Temp Open	DigIN:0.1	DigIN:E.10	DigIN:0.2	1686	CPX Temperature Fault

③ cc = closing contact; oc = opening contact.

Multi-Purpose Control Application

Output Signals

Delayed Digital Output 1 (Keypad: Menu M1 → G1.3.1)

Table 6-14: Delayed Digital Output 1 Parameters — G1.3.1

Code	Parameter	Min.	Max.	Unit	Default	Cust	ID	Note
P1.3.1.1 ①	Digital output 1 signal selection	DigOUT:0.1	DigOUT:E:10		0.1		486	
P1.3.1.2	Digital output 1 function	DigOUT:0.1	DigOUT:E:10		1		312	0 = Not used 1 = Ready 2 = Run 3 = Fault 4 = Fault inverted 5 = FC overheat warning 6 = Ext. fault or warning 7 = Ref. fault or warning 8 = Warning 9 = Reverse 10 = Jogging spd selected 11 = At speed 12 = Mot. regulator active 13 = Freq. limit 1 superv. 14 = Freq. limit 2 superv. 15 = Torque limit superv. 16 = Ref. limit supervision 17 = External brake control 18 = Remote control active 19 = FC temp. limit superv. 20 = Reference inverted 21 = Ext. brake control inverted 22 = Therm. fault or warn. 23 = On/Off control 24 = Fieldbus input data 1 25 = Fieldbus input data 2 26 = Fieldbus input data 3 27 = Fieldbus input data 4 28 = Fieldbus input data 5 29 = SafeDisableA 30 = ChargeSW Stat
P1.3.1.3	Digital output 1 on delay	0.00	320.00	s	0.00		487	0.00 = delay not in use
P1.3.1.4	Digital output 1 off delay	0.00	320.00	s	0.00		488	0.00 = delay not in use

Delayed Digital Output 2 (Keypad: Menu M1 → G1.3.2)

Table 6-15: Delayed Digital Output 2 Parameters — G1.3.2

Code	Parameter	Min.	Max.	Unit	Default	Cust	ID	Note
P1.3.2.1 ②	Digital output 2 signal selection	DigOUT:0.1	DigOUT:E:10		0.1		489	
P1.3.2.2	Digital output 2 function	DigOUT:0.1	DigOUT:E:10		0		490	See par. 1.3.1.2
P1.3.2.3	Digital output 2 on delay	0.00	320.00	s	0.00		491	0.00 = delay not in use
P1.3.2.4	Digital output 2 off delay	0.00	320.00	s	0.00		492	0.00 = delay not in use

August 2010

Multi-Purpose Control Application

Digital Output Signals (Control Keypad: Menu M1 → G1.3.3)

Table 6-16: Digital Output Signals — G1.3.3

Code	Parameter	Min.	Max	Unit	Default	ID	Note
P1.3.3.1 ^②	Ready	DigOUT:0.1	DigOUT:E.10		DigOUT:A.1	432	Ready to run
P1.3.3.2 ^②	Run	DigOUT:0.1	DigOUT:E.10		DigOUT:B.1	433	Running
P1.3.3.3 ^②	Fault	DigOUT:0.1	DigOUT:E.10		DigOUT:B.2	434	Drive in fault state
P1.3.3.4 ^②	Inverted fault	DigOUT:0.1	DigOUT:E.10		DigOUT:0.1	435	Drive not in fault state
P1.3.3.5 ^②	Warning	DigOUT:0.1	DigOUT:E.10		DigOUT:0.1	436	Warning active
P1.3.3.6 ^②	External fault	DigOUT:0.1	DigOUT:E.10		DigOUT:0.1	437	External fault active
P1.3.3.7 ^②	Reference fault/warning	DigOUT:0.1	DigOUT:E.10		DigOUT:0.1	438	4 mA fault active
P1.3.3.8 ^②	Overtemperature warning	DigOUT:0.1	DigOUT:E.10		DigOUT:0.1	439	Drive overtemperature active
P1.3.3.9 ^②	Reverse	DigOUT:0.1	DigOUT:E.10		DigOUT:0.1	440	Output frequency < 0 Hz
P1.3.3.10 ^②	Unrequested direction	DigOUT:0.1	DigOUT:E.10		DigOUT:0.1	441	Reference <> Output frequency
P1.3.3.11 ^②	At speed	DigOUT:0.1	DigOUT:E.10		DigOUT:0.1	442	Reference = Output frequency
P1.3.3.12 ^②	Jogging speed	DigOUT:0.1	DigOUT:E.10		DigOUT:0.1	443	Jogging or preset speed command active
P1.3.3.13 ^②	Remote control	DigOUT:0.1	DigOUT:E.10		DigOUT:0.1	444	IO control active
P1.3.3.14 ^②	External brake control	DigOUT:0.1	DigOUT:E.10		DigOUT:0.1	445	See explanations on Page 8-46
P1.3.3.15 ^②	External brake control inverted	DigOUT:0.1	DigOUT:E.10		DigOUT:0.1	446	See explanations on Page 8-46
P1.3.3.16 ^②	Output frequency limit 1 supervision	DigOUT:0.1	DigOUT:E.10		DigOUT:0.1	447	See ID315
P1.3.3.17 ^②	Output frequency limit 2 supervision	DigOUT:0.1	DigOUT:E.10		DigOUT:0.1	448	See ID346
P1.3.3.18 ^②	Reference limit supervision	DigOUT:0.1	DigOUT:E.10		DigOUT:0.1	449	See ID350
P1.3.3.19 ^②	Temperature limit supervision	DigOUT:0.1	DigOUT:E.10		DigOUT:0.1	450	See ID354
P1.3.3.20 ^②	Torque limit supervision	DigOUT:0.1	DigOUT:E.10		DigOUT:0.1	451	See ID348
P1.3.3.21 ^②	Motor thermal protection	DigOUT:0.1	DigOUT:E.10		DigOUT:0.1	452	
P1.3.3.22 ^②	Analog input supervision limit	DigOUT:0.1	DigOUT:E.10		DigOUT:0.1	463	See ID356
P1.3.3.23 ^②	Motor regulator activation	DigOUT:0.1	DigOUT:E.10		DigOUT:0.1	454	
P1.3.3.24 ^②	Fieldbus input data 1	DigOUT:0.1	DigOUT:E.10		DigOUT:0.1	455	FB CW B11
P1.3.3.29	Safe Disable	DigOUT:0.1	DigOUT:E.10		DigOUT:0.1	1680	
P1.3.3.30	ChargeSwState	DigOUT:0.1	DigOUT:E.10		DigOUT:0.1	1681	
P1.3.3.25 ^②	Fieldbus input data 2	DigOUT:0.1	DigOUT:E.10		DigOUT:0.1	456	FB CW B12
P1.3.3.26 ^②	Fieldbus input data 3	DigOUT:0.1	DigOUT:E.10		DigOUT:0.1	457	FB CW B13

Multi-Purpose Control Application

Table 6-16: Digital Output Signals — G1.3.3 (Continued)

Code	Parameter	Min.	Max	Unit	Default	ID	Note
P1.3.3.27 ②	Fieldbus input data 4	DigOUT:0.1	DigOUT:E.10		DigOUT:0.1	169	FB CW B14
P1.3.3.28 ②	Fieldbus input data 5	DigOUT:0.1	DigOUT:E.10		DigOUT:0.1	170	FB CW B15

CAUTION

Be **ABSOLUTELY** sure not to connect two functions to one and same output in order to avoid function overruns and to ensure flawless operation.

Limit Settings (Control Keypad: Menu M1 → G1.3.4)

Table 6-17: Limit Settings — G1.3.4

Code	Parameter	Min.	Max.	Unit	Default	Cust	ID	Note
P1.3.4.1	Output frequency limit 1 supervision	0	3		0		315	0 = No limit 1 = Low limit supervision 2 = High limit supervision 3 = Brake-on control
P1.3.4.2	Output frequency limit 1; Supervised value	0.00	Par. 1.1.2	Hz	0.00		316	
P1.3.4.3	Output frequency limit 2 supervision	0	4		0		346	0 = No limit 1 = Low limit supervision 2 = High limit supervision 3 = Brake-off control 4 = Brake on/off-control
P1.3.4.4	Output frequency limit 2; Supervised value	0.00	Par. 1.1.2	Hz	0.00		347	
P1.3.4.5	Torque limit supervision	0	3		0		348	0 = Not used 1 = Low limit supervision 2 = High limit supervision 3 = Brake-off control
P1.3.4.6	Torque limit supervision value	-1000.0	1000.0	%	100.0		349	
P1.3.4.7	Reference limit supervision	0	2		0		350	0 = Not used 1 = Low limit 2 = High limit
P1.3.4.8	Reference limit supervision value	0.00	Par. 1.1.2	%	0.00		351	
P1.3.4.9	External brake-off delay	0.0	100.0	s	0.5		352	
P1.3.4.10	External brake-on delay	0.0	100.0	s	1.5		353	
P1.3.4.11	FC temperature supervision	0	2		0		354	0 = Not used 1 = Low limit 2 = High limit
P1.3.4.12	FC temperature supervised value	-10	75	∞C	0		355	

August 2010

Multi-Purpose Control Application

Table 6-17: Limit Settings — G1.3.4 (Continued)

Code	Parameter	Min.	Max.	Unit	Default	Cust	ID	Note
P1.3.4.13	Ain Supv Input	0	4		0		356	0 = Not used 1 = AI1 2 = AI2 3 = AI3 4 = AI4
P1.3.4.14	Ain Supv Llim	0	Par. 1.3.4.15	%	10.00		357	
P1.3.4.15	Ain Supv Hlim	Par. 1.3.4.14	100.00	%	90.00		358	

Analog Output 1 (Control Keypad: Menu M1 → G1.3.5)

Table 6-18: Analog Output 1 Parameters — G1.3.5

Code	Parameter	Min.	Max.	Unit	Default	Cust	ID	Note
P1.3.5.1	Analog output 1 signal selection	AnOUT:0.1	AnOUT:E.10		A.1		464	
P1.3.5.2	Analog output 1 function	0	15		1		307	0 = Not used 1 = Output freq. (0 – f_{max}) 2 = Freq. reference (0 – f_{max}) 3 = Motor speed (0 – Motor nominal speed) 4 = Motor current (0 – I_{nMotor}) 5 = Motor torque (0 – T_{nMotor}) 6 = Motor power (0 – P_{nMotor}) 7 = Motor voltage (0 – U_{nMotor}) 8 = DC-Bus volt (0 – 1000V) 9 = AI1 10 = AI2 11 = Output freq. (f_{min} - f_{max}) 12 = Motor torque (-2...+2x T_{Nmot}) 13 = Motor power (-2...+2x T_{Nmot}) 14 = PT100 temperature 15 = FB Data In 4
P1.3.5.3	Analog output 1 filter time	0.00	10.00	s	1.00		308	0 = No filtering
P1.3.5.4	Analog output 1 inversion	0	1		0		309	0 = Not inverted 1 = Inverted
P1.3.5.5	Analog output 1 minimum	0	1		0		310	0 = 0 mA 1 = 4 mA
P1.3.5.6	Analog output 1 scale	10	1000	%	100		311	
P1.3.5.7	Analog output 1 offset	-100.00	100.00	%	0.00		375	

Multi-Purpose Control Application

Analog Output 2 (Control Keypad: Menu M1 → G1.3.6)

Table 6-19: Analog Output 2 Parameters — G1.3.6

Code	Parameter	Min.	Max.	Unit	Default	Cust	ID	Note
P1.3.6.1 ②	Analog output 2 signal selection	AnOUT:0.1	AnOUT:E.10		0.1		471	
P1.3.6.2	Analog output 2 function	0	13		4		472	See par. 1.3.5.2
P1.3.6.3	Analog output 2 filter time	0.00	10.00	s	1.00		473	0 = No filtering
P1.3.6.4	Analog output 2 inversion	0	1		0		474	0 = Not inverted 1 = Inverted
P1.3.6.5	Analog output 2 minimum	0	1		0		475	0 = 0 mA 1 = 4 mA
P1.3.6.6	Analog output 2 scale	10	1000	%	100		476	
P1.3.6.7	Analog output 2 offset	-100.00	100.00	%	0.00		477	

Analog Output 3 (Control Keypad: Menu M1 → G1.3.7)

Table 6-20: Analog Output 3 Parameters — G1.3.7

Code	Parameter	Min.	Max.	Unit	Default	Cust	ID	Note
P1.3.7.1	Analog output 3 signal selection	AnOUT:0.1	AnOUT:E.10		0.1		478	
P1.3.7.2	Analog output 3 function	0	13		5		479	See par. 1.3.5.2
P1.3.7.3	Analog output 3 filter time	0.00	10.00	s	1.00		480	0 = No filtering
P1.3.7.4	Analog output 3 inversion	0	1		0		481	0 = Not inverted 1 = Inverted
P1.3.7.5	Analog output 3 minimum	0	1		0		482	0 = 0 mA 1 = 4 mA
P1.3.7.6	Analog output 3 scale	10	1000	%	100		483	
P1.3.7.7	Analog output 3 offset	-100.00	100.00	%	0.00		484	

August 2010

Multi-Purpose Control Application

Drive Control Parameters (Control Keypad: Menu M1 → G1.4)

Table 6-21: Drive Control Parameters — G1.4

Code	Parameter	Min.	Max.	Unit	Default	Cust	ID	Note
P1.4.1	Ramp 1 shape	0.0	10.0	s	0.00		500	0 = Linear >0 = S-curve ramp time
P1.4.2	Ramp 2 shape	0.0	10.0	s	0.0		501	0 = Linear >0 = S-curve ramp time
P1.4.3	Acceleration time 2	0.1	3000.0	s	10.0		502	
P1.4.4	Deceleration time 2	0.1	3000.0	s	10.0		503	
P1.4.5 [Ⓢ]	Brake chopper	0	4		0		504	0 = Disabled 1 = Used when running 2 = External brake chopper 3 = Used when stopped/ running 4 = Used when running (no testing)
P1.4.6	Start function	0	1		0		505	0 = Ramp 1 = Flying start
P1.4.7	Stop function	0	3		1		506	0 = Coasting 1 = Ramp 2 = Ramp+Run enable coast 3 = Coast+Run enable ramp
P1.4.8	DC braking current	0.00	I_L	A	$0.7 \times I_H$		507	
P1.4.9	DC braking time at stop	0.00	600.00	s	0.00		508	0 = DC brake is off at stop
P1.4.10	Frequency to start DC braking during ramp stop	0.10	10.00	Hz	1.50		515	
P1.4.11	DC braking time at start	0.00	600.00	s	0.00		516	0 = DC brake is off at start
P1.4.12	Flux brake	0	1		0		520	0 = Off 1 = On
P1.4.13	Flux braking current	$0.1 \times I_H$	$2 \times I_H$	A	I_H		519	
P1.4.14	High Speed Mode	0	1		0/No		1522	0 = No 1 = Yes

Multi-Purpose Control Application

Skip Frequency Parameters (Control Keypad: Menu M1 → G1.5)

Table 6-22: Skip Frequency Parameters — G1.5

Code	Parameter	Min.	Max.	Unit	Default	Cust	ID	Note
P1.5.1	Skip frequency range 1 low limit	0.00	Par. 1.5.2	Hz	0.00		509	
P1.5.2	Skip frequency range 1 high limit	0.00	Par. 1.1.2	Hz	0.00		510	0 = Skip frequency range 1 not used
P1.5.3	Skip frequency range 2 low limit	0.00	Par. 1.5.4	Hz	0.00		511	
P1.5.4	Skip frequency range 2 high limit	0.00	Par. 1.1.2	Hz	0.00		512	0 = Skip frequency range 2 not used
P1.5.5	Skip frequency range 3 low limit	0.00	Par. 1.5.6	Hz	0.00		513	
P1.5.6	Skip frequency range 3 high limit	0.00	Par. 1.1.2	Hz	0.00		514	0 = Skip frequency range 3 not used
P1.5.7	Skip frequency acc./dec. ramp	0.1	10.0	Times	1.0		518	

Motor Control Parameters (Control Keypad: Menu M1 → G1.6)

Table 6-23: Motor Control Parameters — G1.6

Code	Parameter	Min.	Max.	Unit	Default	Cust	ID	Note
P1.6.1 ①	Motor control mode	0	4		0		600	SVX: 0 = Freq Control 1 = OL SpeedCont 2 = OL Torq Ctrl SPX Only 3 = CL SpeedCont 4 = CL Torq Ctrl
P1.6.2 ①	V/Hz Boost	0	1		0		109	0 = Not used 1 = Automatic torque boost
P1.6.3 ①	V/Hz Ratio Select	0	3		0		108	0 = Linear 1 = Squared 2 = Programmable 3 = Linear with flux optim.
P1.6.4 ①	Field weakening point	8.00	650	Hz	60.00		602	
P1.6.5 ①	Voltage at field weakening point	10.00	200.00	%	100.00		603	$n\% \times U_{nmot}$
P1.6.6 ①	V/Hz curve midpoint frequency	0.00	650	Hz	60.00		604	
P1.6.7 ①	V/Hz curve midpoint voltage	0.00	100.00	%	100.00		605	$n\% \times U_{nmot}$ Parameter max. value = par. 1.6.5
P1.6.8 ①	Output voltage at zero frequency	0.00	40.00	%	1.30		606	$n\% \times U_{nmot}$

Multi-Purpose Control Application

Table 6-23: Motor Control Parameters — G1.6 (Continued)

Code	Parameter	Min.	Max.	Unit	Default	Cust	ID	Note
P1.6.9	Switching frequency	1.0	16	kHz	10		601	See Table 8-12 on Page 8-57 for exact values
P1.6.10 [Ⓢ]	Overvoltage controller	0	2		1		607	0 = Not used 1 = Used (no ramping) 2 = Used (ramping)
P1.6.11	Undervoltage controller	0	1		1		608	0 = Off 1 = On:NoRamping 2 = On:Ramping
P1.6.12	Motor control mode 2	0	2/6		2		521	See par. 1.6.1
P1.6.13	Speed controller P gain (open loop)	0	32767		3000		637	
P1.6.14	Speed controller I gain (open loop)	0	32767		300		638	
P1.6.15	Load Drooping	0.00	100.00		0.00		620	Drooping % of nominal speed at nominal torque
P1.6.16	Identification	0	2		0		631	0 = No Action 1 = ID No Run SPX Only 2 = ID With Run

Closed Loop parameter group 1.6.17 (SPX only)

P1.6.17.1	MagnCurrent	0	90	A	0		612	
P1.6.17.2	Speed Control Kp	1	1000		30		613	
P1.6.17.3	Speed Control Ti	-3200	3200	ms	100		614	
P1.6.17.4	Reserved	-32000	32000	x	0		1499	
P1.6.17.5	Accel.Compens.	0	300	s	0		626	
P1.6.17.6	Slip Adjust	0	500	%	75		619	
P1.6.17.7	Start Magn Curr	0	61	A	0		627	
P1.6.17.8	Start Magn Time	0	32000	ms	0		628	
P1.6.17.9	Start 0SpeedTime	0	32000	ms	100		615	
P1.6.17.10	Stop 0 SpeedTime	0	32000	ms	100		616	
P1.6.17.11	StartUp Torque	0	3		0/Not Used		621	0 = Not Used 1 = TorqueMemory 2 = Torque Ref 3 = Torq Fwd/Rev
P1.6.17.12	Startup Torq FWD	-300	300	%	0		633	
P1.6.17.13	Startup Torq REV	-300	300	%	0		634	
P1.6.17.14	Reserved	-32000	32000	x	0		1499	
P1.6.17.15	Encoder1FiltTime	0	100	ms	0		618	
P1.6.17.16	Reserved	-32000	32000	x	0		1499	
P1.6.17.17	CurrentControlKp	0	100	%	40		617	
P.1.6.17.18	Reserved	-32000	32000	x	0		1499	

Multi-Purpose Control Application

Protections (Control Keypad: Menu M1 → G1.7)

Table 6-24: Protections — G1.7

Code	Parameter	Min.	Max.	Unit	Default	Cust	ID	Note
P1.7.1	Ref Fault Resp	0	5		0		700	0 = No Action 1 = Warning 2 = Warn:Stop 3 = Warn:PrevFre 4 = Warn:PresetF 5 = Fault 6 = Fault,Coast
P1.7.2	Ref Fault Freq.	0.00	Par. 1.1.2	Hz	0.00		728	
P1.7.3	Response to external fault	0	3		2		701	0 = No response 1 = Warning 2 = Fault.stop acc. to 1.4.7 3 = Fault.stop by coasting
P1.7.4	Input phase supervision	0	3		3		730	
P1.7.5	Response to undervoltage fault	1	3		0		727	
P1.7.6	Output phase supervision	0	3		2		702	
P1.7.7	Earth fault protection	0	3		2		703	
P1.7.8	Thermal protection of the motor	0	3		2		704	
P1.7.9	Motor ambient temperature factor	-100.0	100.0	%	0.0		705	
P1.7.10	Motor cooling factor at zero speed	0.0	150.0	%	40.0		706	
P1.7.11	Motor thermal time constant	1	200	min	40		707	
P1.7.12	Motor duty cycle	0	100	%	100		708	
P1.7.13	Stall protection	0	3		0		709	0 = No response 1 = Warning 2 = Fault.stop acc. to 1.4.7 3 = Fault.stop by coasting
P1.7.14	Stall current	0.00	$I_{nMotor} \times 2$	A	I_L		710	
P1.7.15	Stall time limit	1.00	120.00	s	15.00		711	

August 2010

Multi-Purpose Control Application

Table 6-24: Protections — G1.7 (Continued)

Code	Parameter	Min.	Max.	Unit	Default	Cust	ID	Note
P1.7.16	Stall frequency limit	1.0	Par. 1.1.2	Hz	25.0		712	
P1.7.17	Underload protection	0	3		0		713	0 = No response 1 = Warning 2 = Fault.stop acc. to 1.4.7 3 = Fault.stop by coasting
P1.7.18	Field weakening area load	10.0	150.0	%	50.0		714	
P1.7.19	Zero frequency load	5.0	150.0	%	10.0		715	
P1.7.20	Underload protection time limit	2.00	600.00	s	20.00		716	
P1.7.21	Response to thermistor fault	0	3		2		732	0 = No response 1 = Warning 2 = Fault.stop acc. to 1.4.7 3 = Fault.stop by coasting
P1.7.22	Response to fieldbus fault	0	3		2		733	See P1.7.21
P1.7.23	Response to slot fault	0	3		2		734	See P1.7.21
P1.7.24	No. of PT100 inputs	0	3		0		739	
P1.7.25	Response to PT100 fault	0	3		0		740	0 = No response 1 = Warning 2 = Fault.stop acc. to 1.4.7 3 = Fault.stop by coasting
P1.7.26	PT100 warning limit	-30.0	200.0	C°	120.0		741	
P1.7.27	PT100 fault limit	-30.0	200.0	C°	130.0		742	
P1.7.28	PT100 Numbers 2	0	3		0		743	
P1.7.29	PT100 Flt Resp 2	0	3		0/No Action		744	See External Fault
P1.7.30	PT100WarnLimit2	-30	200	°C	120		745	
P1.7.31	PT100 FltLimit 2	-30	200	°C	130		746	
P1.7.32	FB WatchdogDelay	0	10.00	s	0		1354	0 = Not monitored
P1.7.33	FCW monitor bit	0	1		1 / Fault High		771	
P1.7.34	FB monitor delay	0	10.00	s	0		772	0 = Not monitored
P1.7.35	Ref fault select	0	4		1 / AI2		770	0 = AI1 1 = AI2 2 = AI3 3 = AI4 4 = Fieldbus
SPX Only								
P1.7.36	SafeDisable Mode	1	2		1/ Warning		755	1 = Warning 2 = Fault

Multi-Purpose Control Application

Autorestart Parameters (Control Keypad: Menu M1 → G1.8)

Table 6-25: Autorestart Parameters — G1.8

Code	Parameter	Min.	Max.	Unit	Default	Cust	ID	Note
P1.8.1	Wait time	0.10	10.00	s	0.50		717	
P1.8.2	Trial time	0.00	60.00	s	30.00		718	
P1.8.3	Start mode	0	2		0		719	0 = Ramp 1 = Flying start 2 = According to par. 1.4.6
P1.8.4	Number of tries after undervoltage trip	0	10		0		720	
P1.8.5	Number of tries after overvoltage trip	0	10		0		721	
P1.8.6	Number of tries after overcurrent trip	0	3		0		722	
P1.8.7	Number of tries after reference trip	0	10		0		723	
P1.8.8	Number of tries after motor temperature fault trip	0	10		0		726	
P1.8.9	Number of tries after external fault trip	0	10		0		725	
P1.8.10	Number of tries after underload fault trip	0	10		1		738	

Fieldbus Parameters (Control Keypad: Menu M1 → G1.9)

Table 6-26: Fieldbus Parameters — G1.9

Code	Parameter	Min.	Max.	Unit	Default	Cust	ID	Note
P1.9.1	Fieldbus min scale	0.00	320.00	Hz	0.00		850	
P1.9.2	Fieldbus max scale	0.00	320.00	Hz	0.00		851	
P1.9.3	Fieldbus data out 1 selection	0	10000		1		852	Choose monitoring data with parameter ID
P1.9.4	Fieldbus data out 2 selection	0	10000		2		853	Choose monitoring data with parameter ID
P1.9.5	Fieldbus data out 3 selection	0	10000		3		854	Choose monitoring data with parameter ID
P1.9.6	Fieldbus data out 4 selection	0	10000		4		855	Choose monitoring data with parameter ID
P1.9.7	Fieldbus data out 5 selection	0	10000		5		856	Choose monitoring data with parameter ID
P1.9.8	Fieldbus data out 6 selection	0	10000		6		857	Choose monitoring data with parameter ID

August 2010

Multi-Purpose Control Application

Table 6-26: Fieldbus Parameters — G1.9 (Continued)

Code	Parameter	Min.	Max.	Unit	Default	Cust	ID	Note
P1.9.9	Fieldbus data out 7 selection	0	10000		7		858	Choose monitoring data with parameter ID
P1.9.10	Fieldbus data out 8 selection	0	10000		37		859	Choose monitoring data with parameter ID
P1.9.11	FB Data In1 Sel	0	2000		0		876	Writes to drive ID only on a change
P1.9.12	FB Data In2 Sel	0	2000		0		877	Writes to drive ID only on a change

Torque Control Parameters (Control Keypad: Menu M1 → G1.10)

Table 6-27: Torque Control Parameters — G1.10

Code	Parameter	Min.	Max.	Unit	Default	Cust	ID	Note
P1.10.1	Torque limit	0.0	400.0	%	300.0		609	
P1.10.2	Torque limit control P-gain	0.0	32000		3000		610	
P1.10.3	Torque limit control I-gain	0.0	32000		200		611	
P1.10.4	Torque reference selection	0	8		0		641	0 = Not used 1 = AI1 2 = AI2 3 = AI3 4 = AI4 5 = AI1 joystick 6 = AI2 joystick 7 = Torque reference from keypad, R2.4 8 = Fieldbus
P1.10.5	Torque reference max.	-300.0	300.0	%	100		642	
P1.10.6	Torque reference min.	-300.0	300.0	%	0.0		643	
P1.10.7	Torque speed limit	0	2		1		644	0 = Max frequency 1 = Selected freq. reference 2 = Preset speed 7
P1.10.8	Minimum frequency for open loop torque control	0.00	par.1.1.1	Hz	3.00		636	
P1.10.9	Torque controller P gain	0	32000		150		639	
P1.10.10	Torque controller I gain	0	32000		10		640	

Multi-Purpose Control Application

Keypad Control (Control Keypad: Menu M2)

The parameters for the selection of control place and direction on the keypad are listed below. See the Keypad control menu in the *9000X AF Drives User Manual*.

Table 6-28: Keypad Control Parameters — M2

Code	Parameter	Min.	Max.	Unit	Default	Cust	ID	Note
P2.1	Control place	0	2		0 Keypad L/R		1685	0 = Keypad L/R 1 = Local 2 = Remote 3 = I/O Select
R2.2	Keypad reference	Par. 1.1.1	Par. 1.1.2	Hz				
P2.3	Direction (on keypad)	0	1		0		123	0 = Forward 1 = Reverse
P2.4	Stop button	0	1		1		114	0 = Limited function of Stop button 1 = Stop button always enabled
R2.5	Torque reference	0.0	100.0	%	0.0			
P2.6	Hide Operate M	0	1		0/No		1707	0 = No 1 = Yes

System Menu (Control Keypad: Menu M5)

For parameters and functions related to the general use of the drive, such as application and language selection, customized parameter sets or information about the hardware and software, see *Chapter 5* in the *9000X AF Drives User Manual*.

Expander Boards (Control Keypad: Menu M6)

The **M6** menu shows the expander and option boards attached to the control board and board-related information. For more information, see *Chapter 5* in the *9000X AF Drives User Manual*.

August 2010

Chapter 7 — Pump and Fan Control Application

Introduction

Select the Pump and Fan Control Application in menu **M5**. See *Chapter 5* of the *9000X AF Drives User Manual*.

The Pump and Fan Control Application can be used to control one variable speed drive and up to four auxiliary drives. The PID controller of the frequency converter controls the speed of the variable speed drive and gives control signals to start and stop the auxiliary drives to control the total flow. In addition to the eight parameter groups provided as standard, a parameter group for multi-pump and fan control functions is available.

The application has two control places on the I/O terminal. Place A is the pump and fan control and place B is the direct frequency reference. The control place is selected with input DIN6.

As already its name tells, the Pump and Fan Control Application is used to control the operation of pumps and fans. It can be used, for example, to decrease the delivery pressure in booster stations if the measured input pressure falls below a limit specified by the user.

The application utilizes external contactors for switching between the motors connected to the frequency converter. The autochange feature provides the capability of changing the starting order of the auxiliary drives. Autochange between 2 drives (main drive + 1 auxiliary drive) is set as default. See **Page 7-5**.

- All inputs and outputs are freely programmable

Additional functions:

- Analog input signal range selection
- Two frequency limit supervisions
- Torque limit supervision
- Reference limit supervision
- Second ramps and S-shape ramp programming
- Programmable Start/Stop and Reverse logic
- DC-brake at start and stop
- Three skip frequency areas
- Programmable U/f curve and switching frequency
- Autorestart
- Motor thermal and stall protection: fully programmable; off, warning, fault
- Motor underload protection
- Input and output phase supervision
- Sleep function

The parameters of the Basic Application are explained in **Chapter 8** of this manual. The explanations are arranged according to the individual ID number of the parameter.

Pump and Fan Control Application

Control I/O

Table 7-1: Pump and Fan Control Application Default I/O Configuration and Connection Example (with 2-wire transmitter)

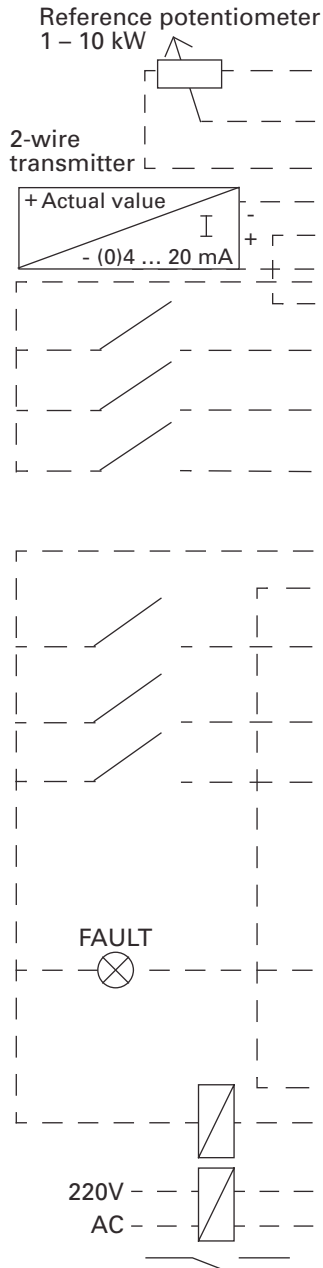

Terminal	Signal	Description
OPTA1		
1	+10V _{ref}	Reference output Voltage for potentiometer, etc.
2	AI1+	Analog input, voltage range 0 – 10V DC Voltage input frequency reference
3	AI1-	I/O Ground Ground for reference and controls
4	AI2+	Analog input, current range 0 – 20mA Current input frequency reference
5	AI2-	
6	+24V ●	Control voltage output Voltage for switches, etc. max 0.1A
7	● GND	I/O ground Ground for reference and controls
8	DIN1	Start/Stop; Control place A (PID controller) (programm.) Contact closed = start
9	DIN2	Interlock 1 (programmable) Contact closed = Interlock used Contact open = Interlock not used
10	DIN3	Interlock 2 (programmable) Contact closed = Interlock used Contact open = Interlock not used
11	CMA	Common for DIN1 – DIN3 Connect to GND or +24V
12	+24V ●	Control voltage output Voltage for switches (see #6)
13	● GND	I/O ground Ground for reference and controls
14	DIN4	Start/Stop Control place B (Direct frequency reference) (programmable) Contact closed = Start
15	DIN5	Jogging speed selection (programmable) Contact closed = Jogging speed active
16	DIN6	Control place A/B selection (programmable) Contact open = Control place A is active Contact closed = Control place B is active
17	CMB	Common for DIN4 – DIN6 Connect to GND or +24V
18	AO1+	Output frequency Analog output Programmable; See Tables 7-12, 7-13 and 7-14 Range 0 – 20 mA/R _L , max. 500W
19	● AO1- (GND)	
20	DO1	Digital output FAULT Programmable Open collector, I ≤ 50 mA, V ≤ 48V DC
OPTA2		
21	RO1	Relay output 1 RUN Programmable, see Table 7-10
22	RO1	
23	RO1	
24	RO2	Relay output 2 FAULT Programmable, see Table 7-10
25	RO2	
26	RO2	

Note: For more information on jumper selections, see the *9000X AF Drives User Manual, Chapter 4.*

**Jumper Block X3:
CMA and CMB
Grounding**

- CMA connected to GND
- CMB connected to GND
- CMA isolated from GND
- CMB isolated from GND
- CMA and CMB internally connected together, isolated from GND

= Factory default

August 2010

Pump and Fan Control Application

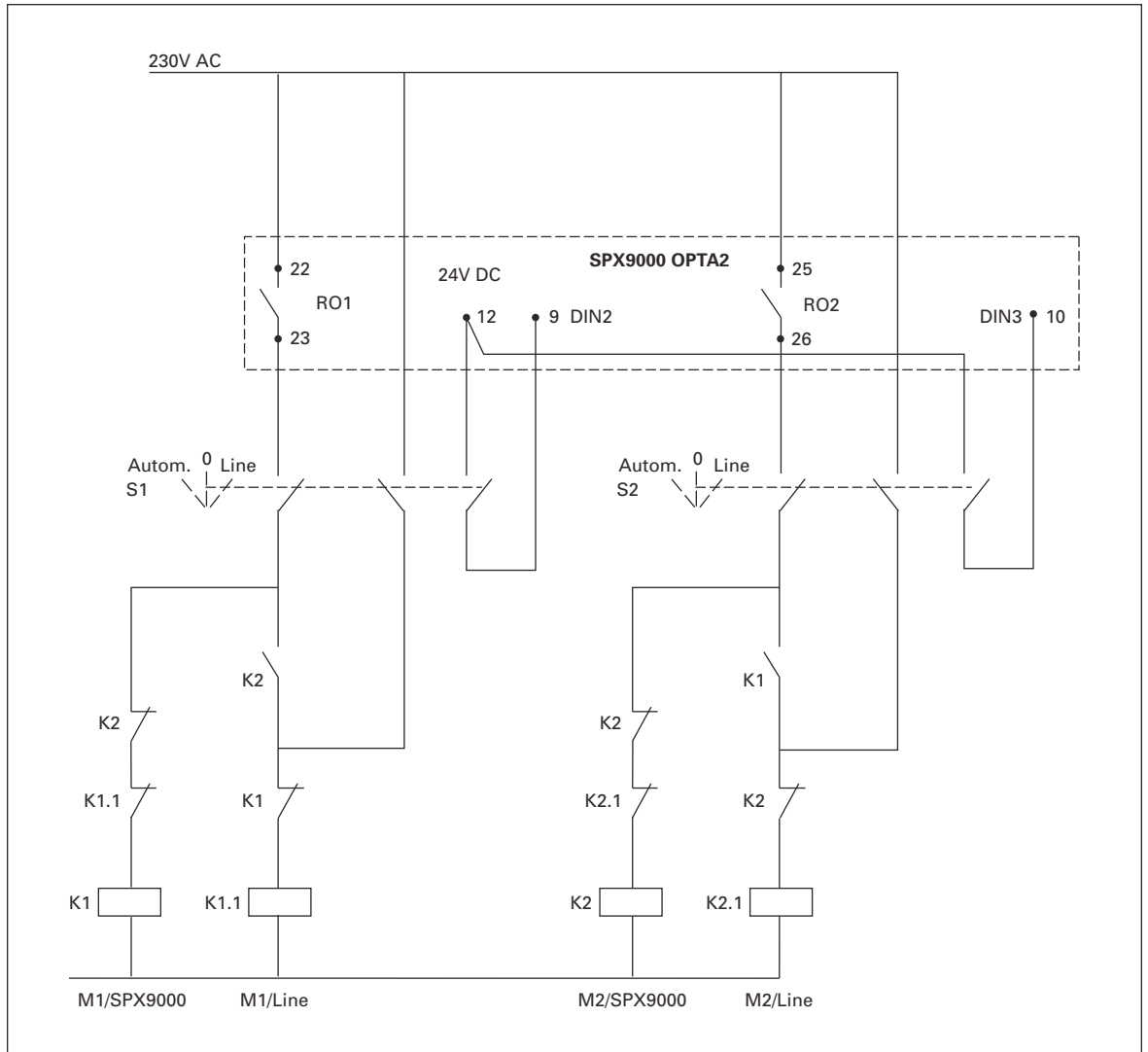

Figure 7-1: 2-Pump Autochange System Principal Control Diagram

Pump and Fan Control Application

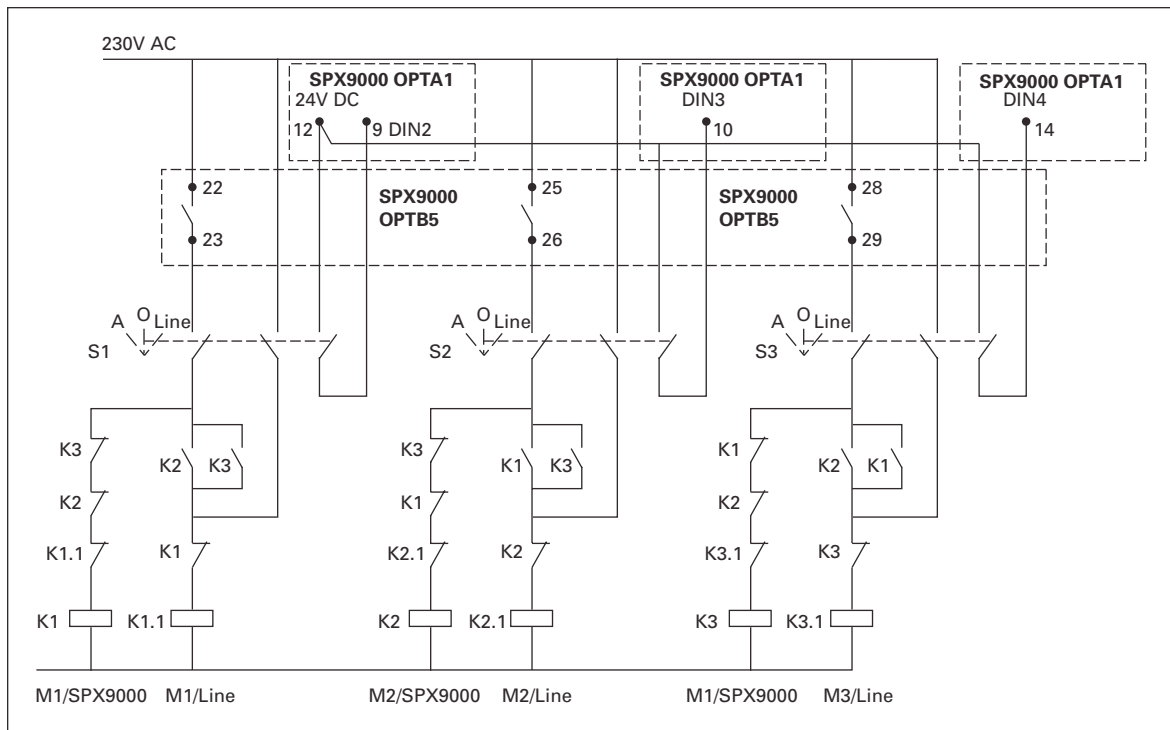

Figure 7-2: 3-Pump Autochange System Principal Control Diagram

Pump and Fan Control Application

Short Description of Function and Essential Parameters

Automatic Changing Between Drives (Autochange, P1.9.24)

The *Autochange function* allows the starting and stopping order of drives controlled by the pump and fan automatics to be changed at desired intervals. The drive controlled by frequency converter can also be included in the automatic changing and locking sequence (par. 1.9.25). The Autochange function makes it possible to equalize the run times of the motors and to prevent e.g. pump stalls due to too long running breaks.

- Apply the Autochange function with parameter 1.9.24, *Autochange*.
- The autochange takes place when the time set with parameter 1.9.26, *Autochange interval*, has expired and the capacity used is below the level defined with parameter 1.9.28, *Autochange frequency limit*.
- The running drives are stopped and re-started according to the new order.
- External contactors controlled through the relay outputs of the frequency converter connect the drives to the frequency converter or to the mains. If the motor controlled by the frequency converter is included in the autochange sequence, it is always controlled through the relay output activated first. The other relays activated later control the auxiliary drives (see **Figure 7-4** and **Figure 7-5**).

Parameter 1.9.24 — Autochange

- 0 Autochange not used
- 1 Autochange used

The automatic change of starting and stopping order is activated and applied to either the auxiliary drives only or the auxiliary drives **and** the drive controlled by the frequency converter, depending on the setting of parameter 1.9.25, *Automatics selection*. By default, the Autochange is activated for 2 drives. See **Figure 7-1** and **Figure 7-4**.

Parameter 1.9.25 — Autochange/Interlockings Automatics Selection

- 0 Automatics (autochange/interlockings) applied to auxiliary drives only

The drive controlled by the frequency converter remains the same. Therefore, mains contactor is needed for one auxiliary drive only.

- 1 All drives included in the autochange/interlockings sequence

The drive controlled by the frequency converter is included in the automatics and a contactor is needed for each drive to connect it to either the mains or the frequency converter.

Parameter 1.9.26 — Autochange interval

After the expiry of the time defined with this parameter, the autochange function takes place if the capacity used lies below the level defined with parameters 1.9.28 (*Autochange frequency limit*) and 1.9.27 (*Maximum number of auxiliary drives*). Should the capacity exceed the value of P1.9.28, the autochange will not take place before the capacity goes below this limit.

- The time count is activated only if the Start/Stop request is active at control place A.
- The time count is reset after the autochange has taken place or on removal of Start request at control place A.

Pump and Fan Control Application

Parameters 1.9.27 — Maximum Number of Auxiliary Drives and 1.9.28 — Autochange Frequency Limit

These parameters define the level below which the capacity used must remain so that the autochange can take place.

This level is defined as follows:

- If the number of running auxiliary drives is smaller than the value of parameter 1.9.27 the autochange function can take place.
- If the number of running auxiliary drives is equal to the value of parameter 1.9.27 and the frequency of the controlled drive is below the value of parameter 1.9.28 the autochange can take place.
- If the value of parameter 1.9.28 is 0.0 Hz, the autochange can take place only in rest position (Stop and Sleep) regardless of the value of parameter 1.9.27.

Interlock Selection (P1.9.23)

This parameter is used to activate the interlock inputs. The interlocking signals come from the motor switches. The signals (functions) are connected to digital inputs which are programmed as interlock inputs using the corresponding parameters. The pump and fan control automatics only control the motors with active interlock data.

- The interlock data can be used even when the Autochange function is not activated.
- If the interlock of an auxiliary drive is inactivated and another unused auxiliary drive available, the latter will be put to use without stopping the frequency converter.
- If the interlock of the controlled drive is inactivated, all motors will be stopped and re-started with the new setup.
- If the interlock is re-activated in Run status, the automatics functions according to parameter 1.9.23, *Interlock selection*:

- 0 Not used
- 1 Update in stop

Interlocks are used. The new drive will be placed last in the autochange line without stopping the system. However, if the autochange order now becomes, for example, [P1 → P3 → P4 → P2], it will be updated in the next Stop (autochange, sleep, stop, etc.).

Example:

[P1 → P3 → P4] → [P2 LOCKED] → [P1 → P3 → P4 → P2] → [SLEEP] → [P1 → P2 → P3 → P4]

- 2 Stop & Update

Interlockings are used. The automatics will stop all motors immediately and re-start with a new setup.

Example:

[P1 → P2 → P4] → [P3 LOCKED] → [STOP] → [P1 → P2 → P3 → P4]

See **Page 7-7** Examples.

Pump and Fan Control Application

Examples

Pump and fan automatics with interlocks and no autochange

Situation: One controlled drive and three auxiliary drives.

Parameter settings: 1.9.1 = 3, 1.9.25 = 0

Interlock feedback signals used, autochange not used.

Parameter settings: 1.9.23 = 1, 1.9.24 = 0

The interlock feedback signals come from the digital inputs selected with parameters 1.2.6.18 to 1.2.6.21.

The Auxiliary drive 1 control (par. 1.3.1.27) is enabled through Interlock 1 (par. 1.2.6.18), the Auxiliary drive 2 control (par. 1.3.1.28) through Interlock 2 (par. 1.2.6.19) etc.

- Phases:
- 1) The system and the motor controlled by the frequency converter are started.
 - 2) The Auxiliary drive 1 starts when the main drive reaches the starting frequency set (par. 1.9.2).
 - 3) The main drive decreases speed down to Auxiliary drive 1 Stop frequency (par. 1.9.3) and starts to rise toward the Start frequency of Auxiliary drive 2, if needed.
 - 4) The Auxiliary drive 2 starts when the main drive has reached the starting frequency set (par. 1.9.4).
 - 5) The Interlock feedback is removed from Aux. drive 2. Because the Aux. drive 3 is unused, it will be started to replace the removed Aux. drive 2.
 - 6) The main drive increases speed to maximum because no more auxiliary drives are available.
 - 7) The removed Aux. drive 2 is reconnected and placed last in the auxiliary drive start order which now is 1-3-2. The main drive decreases speed to the set Stop frequency. The auxiliary drive start order will be updated either immediately or in the next Stop (autochange, sleep, stop, etc.) according to par. 1.9.23.
 - 8) If still more power is needed, the main drive speed rises up to the maximum frequency placing 100% of the output power in the system's disposal.

When the need of power decreases, the auxiliary drives turn off in the opposite order (2-3-1; after the update 3-2-1).

Pump and Fan Control Application

Pump and fan automatics with interlocks and autochange

The above is also applicable if the autochange function is used. In addition to the changed and updated start order, also the change order of main drives depends on parameter 1.9.23.

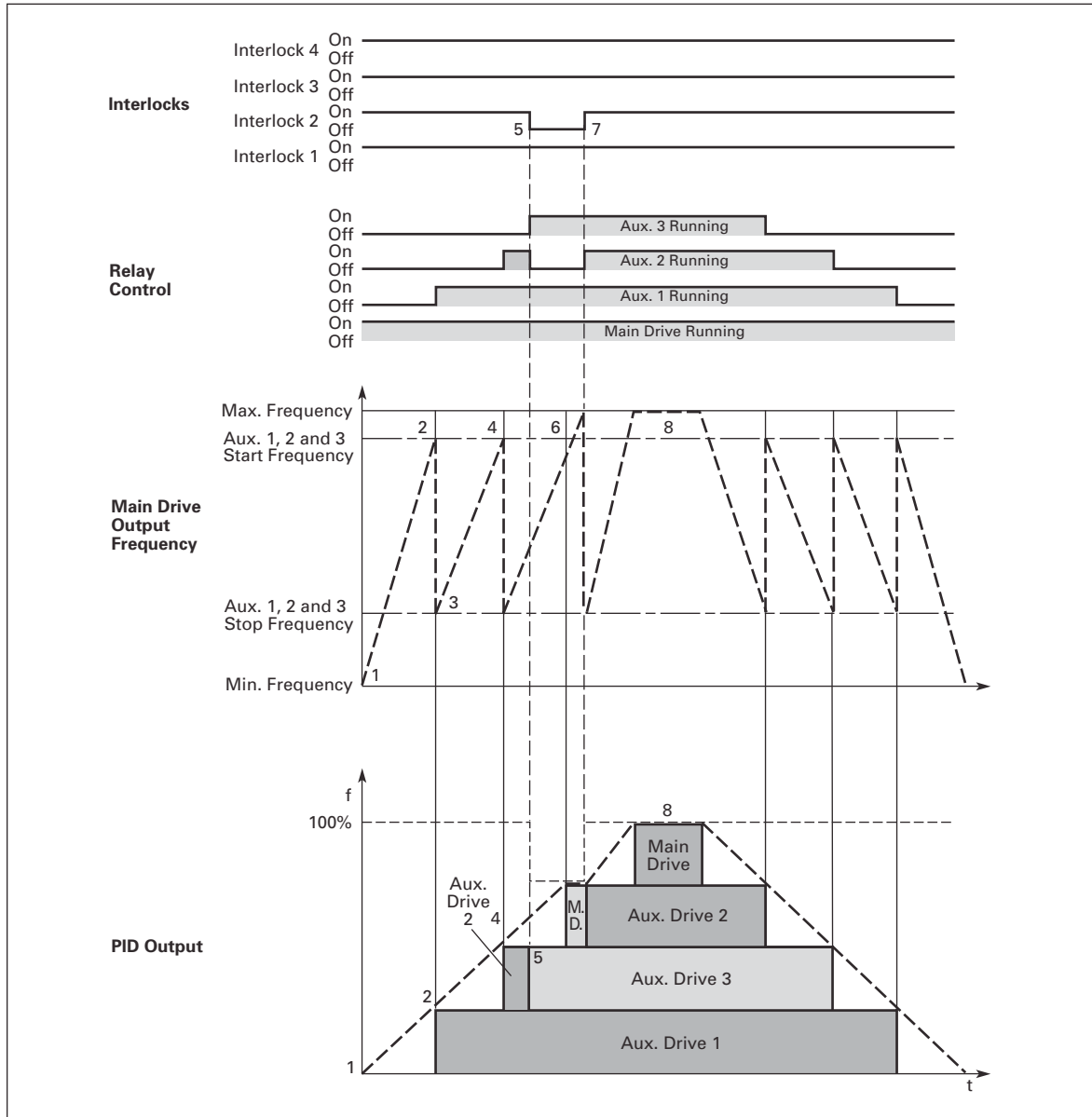

Figure 7-3: Example of the Function of the PFC Application with Three Aux. Drives

Pump and Fan Control Application

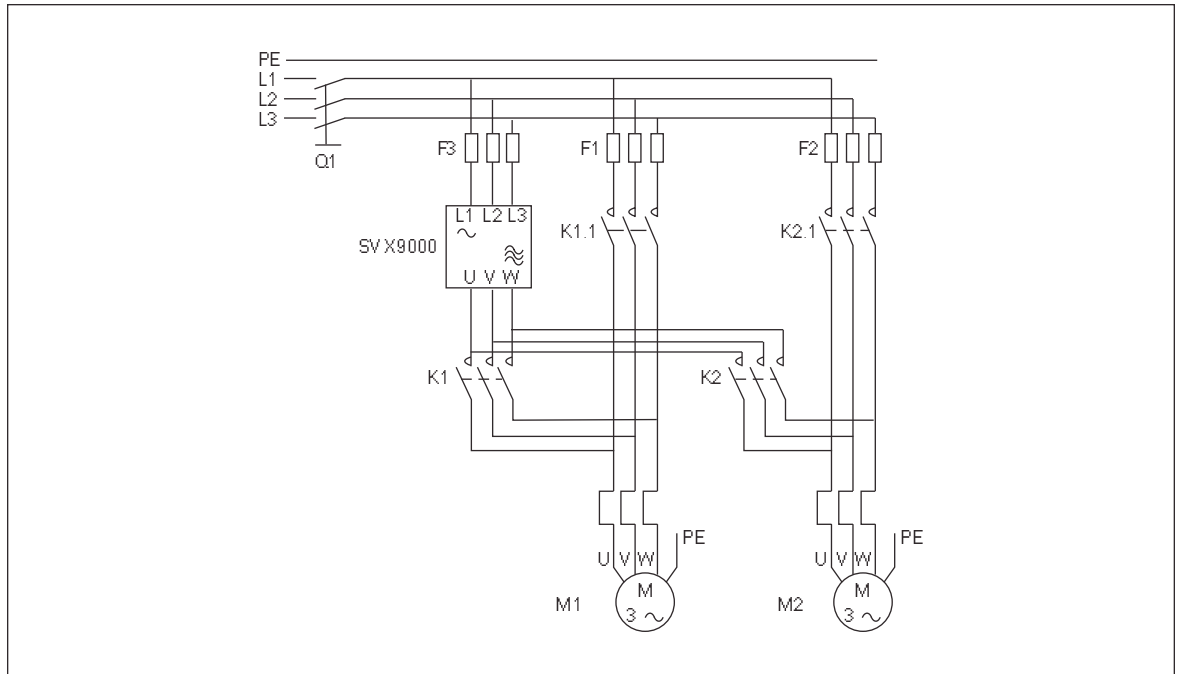

Figure 7-4: Example of 2-Pump Autochange, Main Diagram

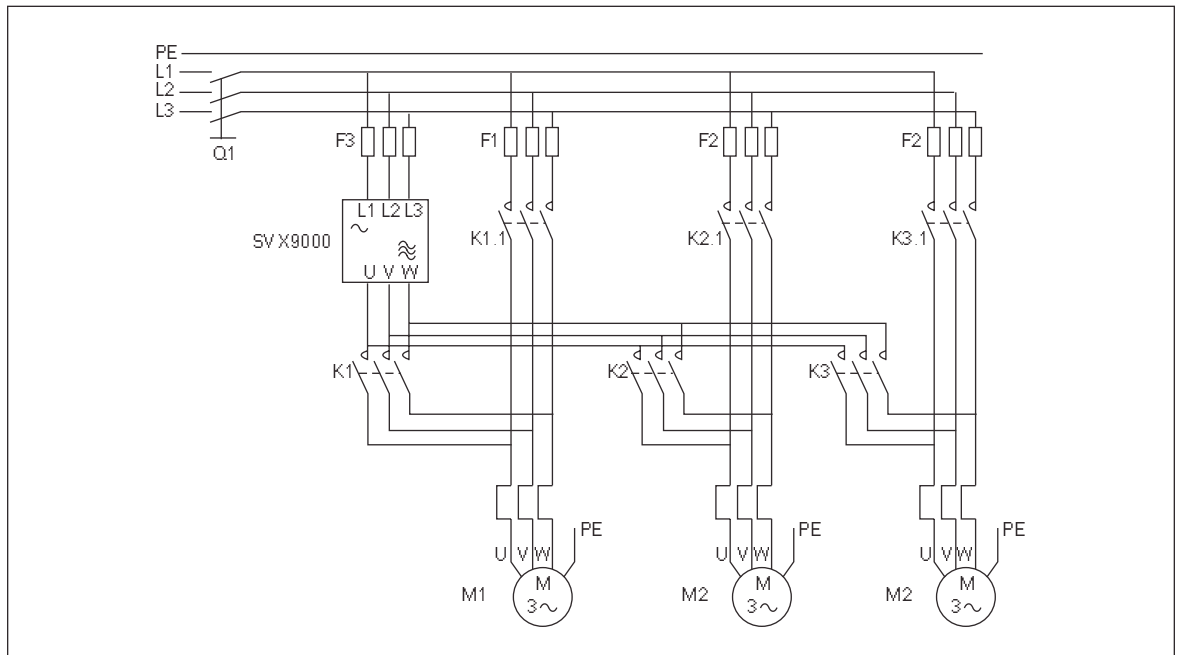

Figure 7-5: Example of 3-Pump Autochange, Main Diagram

Pump and Fan Control Application

Parameter Lists

On the next pages you will find the lists of parameters within the respective parameter groups. The parameter descriptions are given in **Chapter 8**.

Column explanations:

Code	=	Location indication on the keypad; Shows the operator the present parameter number
Parameter	=	Name of parameter
Min.	=	Minimum value of parameter
Max.	=	Maximum value of parameter
Unit	=	Unit of parameter value; Given if available
Default	=	Value preset by factory
Cust	=	User's customized setting
ID	=	ID number of the parameter for reference to Chapter 8
①	=	Parameter value can only be changed after the drive has been stopped
②	=	Programmed using <i>terminal to function</i> (TTF) method. See Page 6-3 .

Monitoring Values (Control Keypad: Menu M8)

The monitoring values are the actual values of parameters and signals as well as statuses and measurements. Monitoring values cannot be edited.

See *9000X AF Drives User Manual, Chapter 5* for more information. Note that the monitoring values V1.18 to V1.23 are available in the PFC control application only.

Table 7-2: Monitoring Values

Code	Parameter	Unit	ID	Description
V1.1	Output frequency	Hz	1	Output frequency to motor
V1.2	Frequency reference	Hz	25	Frequency reference to motor control
V1.3	Motor speed	rpm	2	Motor speed in rpm
V1.4	Motor current	A	3	
V1.5	Motor torque	%	4	In % of Motor nominal torque
V1.6	Motor power	%	5	Motor shaft power
V1.7	Motor voltage	V	6	
V1.8	DC link voltage	V	7	
V1.9	Unit temperature	°C	8	Heatsink temperature
V1.10	Motor temperature	%	9	Calculated motor temperature
V1.11	Analog input 1	V/mA	13	AI1 input value
V1.12	Analog input 2	V/mA	14	AI2 input value
V1.13	DIN1, DIN2, DIN3		15	Digital input statuses
V1.14	DIN4, DIN5, DIN6		16	Digital input statuses
V1.15	Analog I _{out}	mA	26	AO1
V1.16	Analog input 3	V/mA	27	AI3 input value

August 2010

Pump and Fan Control Application

Table 7-2: Monitoring Values (Continued)

Code	Parameter	Unit	ID	Description
V1.17	Analog input 4	V/mA	28	AI4 input value
V1.18	PID Reference	%	20	In % of the max. frequency
V1.19	PID Actual value	%	21	In % of the max actual value
V1.20	PID Error value	%	22	In % of the max error value
V1.21	PID Output	%	23	In % of the max output value
V1.22	Running auxiliary drives		30	Number of running auxiliary drives
V1.23	Special display for actual value		29	See parameters 1.9.29 to 1.9.31
V1.24	PT-100 temperature	C°		Highest temperature of used PT100 inputs
G1.25	Multimonitoring items			Displays 3 selectable monitor. values

Basic Parameters (Control Keypad: Menu M1 → G1.1)

Table 7-3: Basic Parameters — G1.1

Code	Parameter	Min.	Max.	Unit	Default	Cust	ID	Note
P1.1.1	Min frequency	0.00	Par. 1.1.2	Hz	0.00		101	
P1.1.2	Max frequency	Par. 1.1.1	320.00	Hz	60.00		102	NOTE: If f_{max} > than the motor synchronous speed, check suitability for motor and drive system.
P1.1.3	Acceleration time 1	0.1	3000.0	s	1.0		103	
P1.1.4	Deceleration time 1	0.1	3000.0	s	1.0		104	
P1.1.5	Current limit	$0.4 \times I_H$	$2 \times I_H$	A	I_L		107	
P1.1.6 ①	Nominal voltage of the motor	180	690	V	P: 230V P: 460V P: 575V		110	
P1.1.7 ①	Nominal frequency of the motor	30.00	320.00	Hz	60.00		111	Check the rating plate of the motor.
P1.1.8 ①	Nominal speed of the motor	300	20 000	rpm	1720		112	The default applies for a 4-pole motor and a nominal size frequency converter.
P1.1.9 ①	Nominal current of the motor	$0.4 \times I_H$	$2 \times I_H$	A	I_H		113	Check the rating plate of the motor.
P1.1.10 ①	Power factor	0.30	1.00		0.85		120	Check the rating plate of the motor.
P1.1.11 ①	Local control place	1	3		2		171	1 = I/O Terminal 2 = Keypad 3 = Fieldbus
P1.1.12 ①	Remote control place	1	3		1		172	1 = I/O Terminal 2 = Keypad 3 = Fieldbus

Pump and Fan Control Application

Basic Parameters — G1.1 (Continued)

Code	Parameter	Min.	Max.	Unit	Default	Cust	ID	Note
P1.1.13 ①	Local control reference	0	7		4		173	0 = AI1 1 = AI2 2 = AI3 3 = AI4 4 = Keypad reference 5 = Fieldbus reference 6 = Motor potentiometer 7 = PID controller
P1.1.14 ①	Remote control reference	0	7		0		174	0 = AI1 1 = AI2 2 = AI3 3 = AI4 4 = Keypad reference 5 = Fieldbus reference 6 = Motor potentiometer 7 = PID controller
P1.1.15 ①	PID controller reference signal (Place A)	0	6		4		332	0 = AI1 1 = AI2 2 = AI3 3 = AI4 4 = Keypad reference 5 = Fieldbus reference 6 = Motor potentiometer
P1.1.16	PID controller gain	0.0	1000.0	%	100.0		118	
P1.1.17	PID controller I-time	0.00	320.00	s	1.00		119	
P1.1.18	PID controller D-time	0.00	10.00	s	0.00		132	
P1.1.19	Sleep frequency	P1.1.1	P1.1.2	Hz	10.00		1016	
P1.1.20	Sleep delay	0	3600	s	30		1017	
P1.1.21	Wake up limit	0.00	100.00	%	25.00		1018	
P1.1.22	Wake up action	0	3		0		1019	0 = Wake-up when below wake up level (P1.1.21) 1 = Wake-up at when above wake up level (P1.1.21) 2 = Wake-up when below wake up level (PID ref.) 3 = Wake-up when above wake up level (PID ref.)
P1.1.23	Jogging speed reference	0.00	P1.1.2	Hz	10.00		124	

August 2010

Pump and Fan Control Application

Input Signals

Basic Settings (Control Keypad: Menu M1 → G1.2.1)

Table 7-4: Input Signals, Basic Settings — G1.2.1

Code	Parameter	Min.	Max.	Unit	Default	Cust	ID	Note
P1.2.1.1 ①	PID Reference 2	0	7		7		371	0 = AI1 1 = AI2 2 = AI3 3 = AI4 4 = PID reference 1 from keypad 5 = Fieldbus reference (FBProcessDataIN3) 6 = Motor potentiometer 7 = PID reference 2 from keypad
P1.2.1.2	PID error value inversion	0	1		0		340	0 = No inversion 1 = Inversion
P1.2.1.3	PID reference rising time	0.0	100.0		5.0		341	Time for reference value to change from 0% to 100%
P1.2.1.4	PID reference falling time	0.0	100.0		5.0		342	Time for reference value to change from 100% to 0%
P1.2.1.5 ①	PID actual value selection	0	7		0		333	0 = Actual value 1 1 = Actual 1 + Actual 2 2 = Actual 1 – Actual 2 3 = Actual 1 * Actual 2 4 = Max (Actual 1, Actual 2) 5 = Min (Actual 1, Actual 2) 6 = Mean (Actual 1, Actual 2) 7 = Sqrt (Act 1) + Sqrt (Act 2)
P1.2.1.6 ①	Actual value 1 selection	0	5		2		334	0 = Not used 1 = AI1 2 = AI2 3 = AI3 4 = AI4 5 = Fieldbus
P1.2.1.7 ①	Actual value 2 selection	0	5		0		335	0 = Not used 1 = AI1 2 = AI2 3 = AI3 4 = AI4 5 = Fieldbus
P1.2.1.8	Actual value 1 minimum scale	-1600.0	1600.0	%	0.0		336	0.0 = No minimum scaling
P1.2.1.9	Actual value 1 maximum scale	-1600.0	1600.0	%	100.0		337	100.0 = No maximum scaling
P1.2.1.10	Actual value 2 minimum scale	-1600.0	1600.0	%	0.0		338	0.0 = No minimum scaling
P1.2.1.11	Actual value 2 maximum scale	-1600.0	1600.0	%	100.0		339	100.0 = No maximum scaling
P1.2.1.12	Motor potentiometer ramp time	0.1	2000.0	Hz/s	10.0		331	

Pump and Fan Control Application

Table 7-4: Input Signals, Basic Settings — G1.2.1 (Continued)

Code	Parameter	Min.	Max.	Unit	Default	Cust	ID	Note
P1.2.1.13	Motor potentiometer frequency reference memory reset	0	2		1		367	0 = No reset 1 = Reset if stopped or powered down 2 = Reset if powered down
P1.2.1.14	Motor potentiometer PID reference memory reset	0	2		0		370	0 = No reset 1 = Reset if stopped or powered down 2 = Reset if powered down
P1.2.1.15	B reference scale, minimum	0.0	P1.2.1.16	Hz	0.0		344	0.0 = Scaling off >0.0 = Scaled min. value
P1.2.1.16	B reference scale, maximum	P1.2.1.15	320.0	Hz	0.0		345	0.0 = Scaling off >0.0 = Scaled max. value

Analog Input 1 (Control Keypad: Menu M1 → G1.2.2)

Table 7-5: Input Signals, Analog Input 1 — G1.2.2

Code	Parameter	Min.	Max.	Unit	Default	Cust	ID	Note
P1.2.2.1 ^②	AI1 signal selection	AnIN:A.1	AnIN:E.10		AnIN:A.1		377	
P1.2.2.2	AI1 filter time	0.00	10.00	s	0.10		324	0 = No filtering
P1.2.2.3	AI1 signal range	0	2		0		320	0 = Signal range 0 – 100% ^③ 1 = Signal range 20 – 100% ^③ 2 = Custom range ^③
P1.2.2.4	AI1 custom minimum setting	-160.00	160.00	%	0.00		321	
P1.2.2.5	AI1 custom maximum setting	-160.00	160.00	%	100.00		322	
P1.2.2.6	AI1 signal inversion	0.00	320.00	Hz	0.00		323	0 = Not inverted 1 = Inverted

^③ Remember to place jumpers of block X2 accordingly. See *9000X AF Drives User Manual, Chapter 4*.

Analog Input 2 (Control Keypad: Menu M1 → G1.2.3)

Table 7-6: Input Signals, Analog Input 2 — G1.2.3

Code	Parameter	Min.	Max.	Unit	Default	Cust	ID	Note
P1.2.3.1 ^②	AI2 signal selection	AnIN:0.1	AnIN:E.10		AnIN:A.2		388	
P1.2.3.2	AI2 filter time	0.00	10.00	s	0.10		329	0 = No filtering
P1.2.3.3	AI2 signal range	0	2		1		325	0 = 0–10V 1 = 4mA/20%–100% 2 = Custom range ^④
P1.2.3.4	AI2 custom minimum setting	-160.00	160.00	%	0.00		326	
P1.2.3.5	AI2 custom maximum setting	-160.00	160.00	%	100.00		327	
P1.2.3.6	AI2 signal inversion	0.00	320.00	Hz	0.00		328	0 = Not inverted 1 = Inverted

^④ Remember to place jumpers of block X2 accordingly. See *9000X AF Drives User Manual, Chapter 4*.

August 2010

Pump and Fan Control Application

Analog Input 3 (Control Keypad: Menu M1 → G1.2.4)

Table 7-7: Input Signals, Analog Input 3 — G1.2.4

Code	Parameter	Min.	Max.	Unit	Default	Cust	ID	Note
P1.2.4.1 ^②	AI3 signal selection	AnIN:0.1	AnIN:E.10		AnIN:0.1		141	
P1.2.4.2	AI3 filter time	0.00	10.00	s	0.10		142	0 = No filtering
P1.2.4.3	AI3 signal range	0	2		1		143	0 = 0 – 100% ^③ 1 = 4mA/20%–100% ^③ 2 = Custom range ^③
P1.2.4.4	AI3 custom minimum setting	-100.00	100.00	%	0.00		144	
P1.2.4.5	AI3 custom maximum setting	-100.00	100.00	%	100.00		145	
P1.2.4.6	AI3 inversion	0	1		0		151	0 = Not inverted 1 = Inverted

^③ Remember to place jumpers of block X2 accordingly. See 9000X AF Drives User Manual, Chapter 4.

Analog Input 4 (Control Keypad: Menu M1 → G1.2.5)

Table 7-8: Input Signals, Analog Input 4 — G1.2.5

Code	Parameter	Min.	Max.	Unit	Default	Cust	ID	Note
P1.2.5.1 ^②	AI4 signal selection	AnIN:0.1	AnIN:E.10		AnIN:0.1		152	
P1.2.5.2	AI4 filter time	0.00	10.00	s	0.10		153	0 = No filtering
P1.2.5.3	AI4 signal range	0	2		1		154	0 = 0 – 100% ^④ 1 = 4mA/20%–100% ^④ 2 = Custom range ^④
P1.2.5.4	AI4 custom minimum setting	-160.00	160.00	%	0.00		155	
P1.2.5.5	AI4 custom maximum setting	-160.00	160.00	%	100.00		156	
P1.2.5.6	AI4 inversion	0	1		0		162	0 = Not inverted 1 = Inverted

^④ Remember to place jumpers of block X2 accordingly. See 9000X AF Drives User Manual, Chapter 4.

Digital Inputs (Control Keypad: Menu M1 → G1.2.6)

Table 7-9: Input Signals, Digital Inputs — G1.2.6

Code	Parameter	Min.	Max.	Unit	Default	Cust	ID	Note
P1.2.6.1 ^②	Start A signal	DigIN:01	DigIn:E.10		DigIN:A.1		423	
P1.2.6.2 ^②	Start B signal	DigIN:01	DigIn:E.10		DigIN:A.4		424	
P1.2.6.3 ^②	Control place A/B selection	DigIN:01	DigIn:E.10		DigIN:A.6		425	Control place A (oc) ^⑤ Control place B (cc) ^⑤
P1.2.6.4 ^②	External fault (close)	DigIN:01	DigIn:E.10		DigIN:0.1		405	Ext. fault displayed (cc) ^⑤
P1.2.6.5 ^②	External fault (open)	DigIN:01	DigIn:E.10		DigIN:0.1		406	Ext. fault displayed (oc) ^⑤
P1.2.6.6 ^②	Run enable	DigIN:01	DigIn:E.10		DigIN:0.1		407	Motor start enabled (cc) ^⑤
P1.2.6.7 ^②	Acc/Dec time selection	DigIN:01	DigIn:E.10		DigIN:0.1		408	Acc/Dec time 1 (oc) ^⑤ Acc/Dec time 2 (cc) ^⑤

^⑤ cc = closing contact; oc = opening contact.

Pump and Fan Control Application

Table 7-9: Input Signals. Digital Inputs — G1.2.6 (Continued)

Code	Parameter	Min.	Max.	Unit	Default	Cust	ID	Note
P1.2.6.8 ^②	Control from I/O terminal (Force Remote)	DigIN:01	DigIn:E.10		DigIN:0.1		409	Force control place to Remote
P1.2.6.9 ^②	Reverse	DigIN:01	DigIn:E.10		DigIN:0.1		412	Direction forward (oc) ^③ Direction reverse (cc) ^③
P1.2.6.10 ^②	Jogging speed	DigIN:01	DigIn:E.10		DigIN:A.5		413	Jogging speed selected for frequency reference (cc) ^③
P1.2.6.11 ^②	Fault reset	DigIN:01	DigIn:E.10		DigIN:0.1		414	All faults reset (cc) ^③
P1.2.6.12 ^②	Acc/Dec prohibit	DigIN:01	DigIn:E.10		DigIN:0.1		415	Acc/Dec prohibited (cc) ^③
P1.2.6.13 ^②	DC braking	DigIN:01	DigIn:E.10		DigIN:0.1		416	DC braking active (cc) ^③
P1.2.6.14 ^②	Motor potentiometer reference DOWN	DigIN:01	DigIn:E.10		DigIN:0.1		417	Motor potentiometer reference decreases (cc) ^③
P1.2.6.15 ^②	Motor potentiometer reference UP	DigIN:01	DigIn:E.10		DigIN:0.1		418	Motor potentiometer reference increases (cc) ^③
P1.2.6.16 ^②	Autochange 1 Interlock	DigIN:01	DigIn:E.10		DigIN:A.2		426	Activated if cc ^③
P1.2.6.17 ^②	Autochange 2 Interlock	DigIN:01	DigIn:E.10		DigIN:A.3		427	Activated if cc ^③
P1.2.6.18 ^②	Autochange 3 Interlock	DigIN:01	DigIn:E.10		DigIN:0.1		428	Activated if (cc) ^③
P1.2.6.19 ^②	Autochange 4 Interlock	DigIN:01	DigIn:E.10		DigIN:0.1		429	Activated if (cc) ^③
P1.2.6.20 ^②	Autochange 5 Interlock	DigIN:01	DigIn:E.10		DigIN:0.1		430	Activated if (cc) ^③
P1.2.6.21 ^②	PID reference 2	DigIN:01	DigIn:E.10		DigIN:0.1		431	Selected with P1.1.15 (oc) ^③ Selected with P1.2.1.1 (cc) ^③

^③ cc = closing contact; oc = opening contact.

August 2010

Pump and Fan Control Application

Output Signals

Digital Output Signals (Control Keypad: Menu M1 → G1.3.1)

Table 7-10: Output Signals, Digital Outputs — G1.3.1

Code	Parameter	Min.	Max.	Unit	Default	Cust	ID	Note
P1.3.1.1 ^②	Ready	DigOUT:0.1	DigOUT:E.10		DigOUT:0.1		432	
P1.3.1.2 ^②	Run	DigOUT:0.1	DigOUT:E.10		DigOUT:0.1		433	
P1.3.1.3 ^②	Fault	DigOUT:0.1	DigOUT:E.10		DigOUT:A.1		434	
P1.3.1.4 ^②	Inverted fault	DigOUT:0.1	DigOUT:E.10		DigOUT:0.1		435	
P1.3.1.5 ^②	Warning	DigOUT:0.1	DigOUT:E.10		DigOUT:0.1		436	
P1.3.1.6 ^②	External fault/ warning	DigOUT:0.1	DigOUT:E.10		DigOUT:0.1		437	
P1.3.1.7 ^②	Reference fault/ warning	DigOUT:0.1	DigOUT:E.10		DigOUT:0.1		438	
P1.3.1.8 ^②	Overtemperature warning	DigOUT:0.1	DigOUT:E.10		DigOUT:0.1		439	
P1.3.1.9 ^②	Reverse	DigOUT:0.1	DigOUT:E.10		DigOUT:0.1		440	
P1.3.1.10 ^②	Direction difference	DigOUT:0.1	DigOUT:E.10		DigOUT:0.1		441	
P1.3.1.11 ^②	At reference speed	DigOUT:0.1	DigOUT:E.10		DigOUT:0.1		442	
P1.3.1.12 ^②	Jogging speed	DigOUT:0.1	DigOUT:E.10		DigOUT:0.1		443	
P1.3.1.13 ^②	Remote control active	DigOUT:0.1	DigOUT:E.10		DigOUT:0.1		444	
P1.3.1.14 ^②	External brake control	DigOUT:0.1	DigOUT:E.10		DigOUT:0.1		445	
P1.3.1.15 ^②	External brake control, inverted	DigOUT:0.1	DigOUT:E.10		DigOUT:0.1		446	
P1.3.1.16 ^②	Output frequency limit 1 supervision	DigOUT:0.1	DigOUT:E.10		DigOUT:0.1		447	
P1.3.1.17 ^②	Output frequency limit 2 supervision	DigOUT:0.1	DigOUT:E.10		DigOUT:0.1		448	
P1.3.1.18 ^②	Reference limit supervision	DigOUT:0.1	DigOUT:E.10		DigOUT:0.1		449	
P1.3.1.19 ^②	Temperature limit supervision	DigOUT:0.1	DigOUT:E.10		DigOUT:0.1		450	
P1.3.1.20 ^②	Torque limit supervision	DigOUT:0.1	DigOUT:E.10		DigOUT:0.1		451	
P1.3.1.21 ^②	Motor thermal protection	DigOUT:0.1	DigOUT:E.10		DigOUT:0.1		452	
P1.3.1.22 ^②	Analog input supervision limit	DigOUT:0.1	DigOUT:E.10		DigOUT:0.1		463	
P1.3.1.23 ^②	Motor regulator activation	DigOUT:0.1	DigOUT:E.10		DigOUT:0.1		454	

Pump and Fan Control Application

Table 7-10: Output Signals, Digital Outputs — G1.3.1 (Continued)

Code	Parameter	Min.	Max.	Unit	Default	Cust	ID	Note
P1.3.1.24 ^②	Fieldbus digital input 1	DigOUT:0.1	DigOUT:E.10		DigOUT:0.1		455	
P1.3.1.25 ^②	Fieldbus digital input 2	DigOUT:0.1	DigOUT:E.10		DigOUT:0.1		456	
P1.3.1.26 ^②	Fieldbus digital input 3	DigOUT:0.1	DigOUT:E.10		DigOUT:0.1		457	
P1.3.1.27 ^②	Autochange 1/ Aux 1 control	DigOUT:0.1	DigOUT:E.10		DigOUT:B.1		458	
P1.3.1.28 ^②	Autochange 2/ Aux 2 control	DigOUT:0.1	DigOUT:E.10		DigOUT:B.2		459	
P1.3.1.29 ^②	Autochange 3/ Aux 3 control	DigOUT:0.1	DigOUT:E.10		DigOUT:0.1		460	
P1.3.1.30 ^②	Autochange 4/ Aux 4 control	DigOUT:0.1	DigOUT:E.10		DigOUT:0.1		461	
P1.3.1.31 ^②	Autochange 5	DigOUT:0.1	DigOUT:E.10		DigOUT:0.1		462	

Limit Settings (Control Keypad: Menu M1 → G1.3.2)

Table 7-11: Output Signals, Limit Settings — G1.3.2

Code	Parameter	Min.	Max.	Unit	Default	Cust	ID	Note
P1.3.2.1	Output frequency limit 1 supervision	0	2		0		315	0 = No limit 1 = Low limit supervision 2 = High limit supervision
P1.3.2.2	Output freq. limit 1; Supervised value	0.00	P1.1.2	Hz	0.00		316	
P1.3.2.3	Output frequency limit 2 supervision	0	2		0		346	0 = No limit 1 = Low limit supervision 2 = High limit supervision
P1.3.2.4	Output freq. limit 2; Supervised value	0.00	P1.1.2	Hz	0.00		347	
P1.3.2.5	Torque limit supervision	0	2		0		348	0 = Not used 1 = Low limit supervision 2 = High limit supervision
P1.3.2.6	Torque limit supervision value	0.0	300.0	%	100.0		349	
P1.3.2.7	Reference limit supervision	0	2		0		350	0 = Not used 1 = Low limit 2 = High limit
P1.3.2.8	Reference limit supervision value	0.0	100.0	%	0.0		351	
P1.3.2.9	External brake-off delay	0.0	100.0	s	0.5		352	
P1.3.2.10	External brake-on delay	0.0	100.0	s	1.5		353	
P1.3.2.11	FC temperature supervision	0	2		0		354	0 = Not used 1 = Low limit 2 = High limit

August 2010

Pump and Fan Control Application

Table 7-11: Output Signals, Limit Settings — G1.3.2 (Continued)

Code	Parameter	Min.	Max.	Unit	Default	Cust	ID	Note
P1.3.2.12	FC temperature supervised value	-10	75	∞C	40		355	
P1.3.2.13	Supervised analog input	0	1		0		372	0 = AI1 1 = AI2
P1.3.2.14	Analog input supervision limit	0	2		0		373	0 = No limit 1 = Low limit supervision 2 = High limit supervision
P1.3.2.15	Analog input supervised value	0.00	100.00	%	0.00		374	

Analog Output 1 (Control Keypad: Menu M1 → G1.3.3)

Table 7-12: Output Signals, Analog Output 1 — G1.3.3

Code	Parameter	Min.	Max.	Unit	Default	Cust	ID	Note
P1.3.3.1	Analog output signal selection	AnOUT:0.1	AnOUT:E.10		AnOUT:A.1		464	
P1.3.3.2	Analog output function	0	14		1		307	0 = Not used 1 = Output freq. (0 – f_{max}) 2 = Freq. reference (0 – f_{max}) 3 = Motor speed (0 – Motor nominal speed) 4 = Motor current (0 – I_{nMotor}) 5 = Motor torque (0 – T_{nMotor}) 6 = Motor power (0 – P_{nMotor}) 7 = Motor voltage (0 – V_{nMotor}) 8 = DC-link volt (0 – 1000V) 9 = PID controller ref. value 10 = PID contr. act.value 1 11 = PID contr. act.value 2 12 = PID contr. error value 13 = PID controller output 14 = PT100 temperature
P1.3.3.3	Analog output filter time	0.00	10.00	s	1.00		308	0.00 = No filtering
P1.3.3.4	Analog output inversion	0	1		0		309	0 = Not inverted 1 = Inverted
P1.3.3.5	Analog output minimum	0	1		0		310	0 = 0 mA 1 = 4 mA
P1.3.3.6	Analog output scale	10	1000	%	100		311	
P1.3.3.7	I_{out} offset	-100.00	100.00	%	0.00		375	

Pump and Fan Control Application

Analog Output 2 (Control Keypad: Menu M1 → G1.3.4)

Table 7-13: Output Signals, Analog Output 2 — G1.3.4

Code	Parameter	Min.	Max.	Unit	Default	Cust	ID	Note
P1.3.4.1	Analog output 2 signal selection	AnOUT:01	AnOUT:E.10		AnOUT:0.1		471	
P1.3.4.2	Analog output 2 function	0	14		0		472	See P1.3.3.2
P1.3.4.3	Analog output 2 filter time	0.00	10.00	s	1.00		473	0.00 = No filtering
P1.3.4.4	Analog output 2 inversion	0	1		0		474	0 = Not inverted 1 = Inverted
P1.3.4.5	Analog output 2 minimum	0	1		0		475	0 = 0 mA 1 = 4 mA
P1.3.4.6	Analog output 2 scale	10	1000	%	100		476	
P1.3.4.7	Analog output 2 offset	-100.00	100.00	%	0.00		477	

Analog Output 3 (Control Keypad: Menu M1 → G1.3.5)

Table 7-14: Output Signals, Analog Output 3 — G1.3.5

Code	Parameter	Min.	Max.	Unit	Default	Cust	ID	Note
P1.3.5.1	Analog output 3 signal selection	AnOUT:01	AnOUT:E.10		AnOUT:0.1		478	
P1.3.5.2	Analog output 3 function	0	14		0		479	See P1.3.3.2
P1.3.5.3	Analog output 3 filter time	0.00	10.00	s	1.00		480	0.00 = No filtering
P1.3.5.4	Analog output 3 inversion	0	1		0		481	0 = Not inverted 1 = Inverted
P1.3.5.5	Analog output 3 minimum	0	1		0		482	0 = 0 mA 1 = 4 mA
P1.3.5.6	Analog output 3 scale	10	1000	%	100		483	
P1.3.5.7	Analog output 3 offset	-100.00	100.00	%	0.00		484	

August 2010

Pump and Fan Control Application

Drive Control Parameters (Control Keypad: Menu M1 → G1.4)

Table 7-15: Drive Control Parameters — G1.4

Code	Parameter	Min.	Max.	Unit	Default	Cust	ID	Note
P1.4.1	Ramp 1 shape	0.0	10.0	s	0.0		500	0.00 = Linear >0.00 = S-curve ramp time
P1.4.2	Ramp 2 shape	0.0	10.0	s	0.0		501	0.00 = Linear >0.00 = S-curve ramp time
P1.4.3	Acceleration time 2	0.1	3000.0	s	10.0		502	
P1.4.4	Deceleration time 2	0.1	3000.0	s	10.0		503	
P1.4.5 ^①	Brake chopper	0	4		0		504	0 = Disabled 1 = Used when running 2 = External brake chopper 3 = Used when stopped/running 4 = Used when running (no testing)
P1.4.6	Start mode	0	1		0		505	0 = Ramp 1 = Flying start
P1.4.7	Stop mode	0	3		1		506	0 = Coasting 1 = Ramp 2 = Ramp+Run enable coast 3 = Coast+Run enable ramp
P1.4.8	DC braking current	0.4 x I _H	2 x I _H	A	I _H		507	
P1.4.9	DC braking time at stop	0.00	600.00	s	0.00		508	0.00 = DC brake is off at stop
P1.4.10	Frequency to start DC braking during ramp stop	0.10	10.00	Hz	1.50		515	
P1.4.11	DC braking time at start	0.00	600.00	s	0.00		516	0.00 = DC brake is off at start
P1.4.12	Flux brake	0	1		0		520	0 = Off 1 = On
P1.4.13	Flux braking current	0.4 x I _H	2 x I _H	A	I _H		519	

Pump and Fan Control Application

Skip Frequencies (Control Keypad: Menu M1 → G1.5)

Table 7-16: Skip Frequencies— G1.5

Code	Parameter	Min.	Max.	Unit	Default	Cust	ID	Note
P1.5.1	Skip frequency range 1 low limit	0.0	P1.5.2	Hz	0.00		509	
P1.5.2	Skip frequency range 1 high limit	P1.5.1	320.00	Hz	0.00		510	0.00 = Skip frequency range 1 not used
P1.5.3	Skip frequency range 2 low limit	0.00	P1.5.4	Hz	0.00		511	
P1.5.4	Skip frequency range 2 high limit	P1.5.3	320.00	Hz	0.00		512	0.00 = Skip frequency range 2 not used
P1.5.5	Skip frequency range 3 low limit	0.00	P1.5.6	Hz	0.00		513	
P1.5.6	Skip frequency range 3 high limit	P1.5.5	320.00	Hz	0.00		514	0.00 = Skip frequency range 3 not used
P1.5.7	Prohibit acc./dec. ramp	0.1	10.0		1.0		518	Multiplier for ramp time in skip frequency range, e.g. 0.1 – 10% of normal ramp time

Motor Control Parameters (Control Keypad: Menu M1 → G1.6)

Table 7-17: Motor Control Parameters — G1.6

Code	Parameter	Min.	Max.	Unit	Default	Cust	ID	Note
P1.6.1 ①	Motor control mode	0	1		0		600	0 = Frequency control 1 = Speed control
P1.6.2 ①	V/Hz optimization	0	1		0		109	0 = Not used 1 = Automatic torque boost
P1.6.3 ①	V/Hz ratio selection	0	3		0		108	0 = Linear 1 = Squared 2 = Programmable 3 = Linear with flux optim.
P1.6.4 ①	Field weakening point	8.00	320.00	Hz	60.00		602	
P1.6.5 ①	Voltage at field weakening point	10.00	200.00	%	100.00		603	n% × V _{nMotor}
P1.6.6 ①	V/Hz curve midpoint frequency	0.00	P1.6.4	Hz	60.00		604	
P1.6.7 ①	V/Hz curve midpoint voltage	0.00	P1.6.5	%	100.00		605	n% × V _{nMotor} Parameter max. value = par. 1.6.5
P1.6.8 ①	Output voltage at zero frequency	0.00	40.00	%	1.30		606	n% × V _{nMotor}
P1.6.9	Switching frequency	1.0	Varies	kHz	Varies		601	See Table 8-12 on Page 8-57 for exact values
P1.6.10 ①	Overvoltage controller	0	2		1		607	0 = Not used 1 = Used (no ramping) 2 = Used (ramping)
P1.6.11	Undervoltage controller	0	1		1		608	0 = Not used 1 = Used

August 2010

Pump and Fan Control Application

Protections (Control keypad: Menu M1 → G1.7)

Table 7-18: Protections — G1.7

Code	Parameter	Min.	Max.	Unit	Default	Cust	ID	Note
P1.7.1	Response to reference fault	0	5		0		700	0 = No response 1 = Warning 2 = Warning+Previous Freq. 3 = Warning+Preset Freq P1.7.2 4 = Fault, stop acc. to P1.4.7 5 = Fault, stop by coasting
P1.7.2	4mA reference fault frequency	0.00	P1.1.2	Hz	0.00		728	
P1.7.3	Response to external fault	0	3		2		701	0 = No response 1 = Warning 2 = Fault, stop per P1.4.7 3 = Fault, stop by coasting
P1.7.4	Input phase supervision	0	3		3		730	See P1.7.3
P1.7.5	Response to undervoltage fault	0	1		0		727	0 = Fault Stored 1 = No History
P1.7.6	Output phase supervision	0	3		2		702	See P1.7.3
P1.7.7	Ground fault protection	0	3		2		703	See P1.7.3
P1.7.8	Thermal protection of the motor	0	3		2		704	See P1.7.3
P1.7.9	Motor ambient temperature factor	-100.0	100.0	%	0.0		705	
P1.7.10	Motor cooling factor at zero speed	0.0	150.0	%	40.0		706	As a % of In motor
P1.7.11	Motor thermal time constant	1	200	min	45		707	
P1.7.12	Motor duty cycle	0	100	%	100		708	
P1.7.13	Stall protection	0	3		1		709	See P1.7.3
P1.7.14	Stall current	0.1	$I_{nMotor} \times 2$	A	I_L		710	
P1.7.15	Stall time limit	1.00	120.00	s	15.00		711	
P1.7.16	Stall frequency limit	1.0	P1.1.2	Hz	25.00		712	
P1.7.17	Underload protection	0	3		0		713	See P1.7.3
P1.7.18	Underload protect. f_{nom} torque	10	150.0	%	50.0		714	
P1.7.19	Underload protect. f_o torque	5.0	150.0	%	10.0		715	
P1.7.20	Underload protection time limit	2.00	600.00	s	20.00		716	
P1.7.21	Response to thermistor fault	0	3		2		732	See P1.7.3

Pump and Fan Control Application

Table 7-18: Protections — G1.7 (Continued)

Code	Parameter	Min.	Max.	Unit	Default	Cust	ID	Note
P1.7.22	Response to fieldbus fault	0	3		2		733	See P1.7.3
P1.7.23	Response to slot fault	0	3		2		734	See P1.7.3
P1.7.24	No. of PT100 inputs	0	3		0		739	
P1.7.25	Response to PT100 fault	0	1		1		740	0 = Fault stored to history 1 = Fault not stored to history
P1.7.26	PT100 warning limit	-30.0	200.0	°C	120.0		741	
P1.7.27	PT100 fault limit	-30.0	200.0	°C	130.0		742	
P1.7.28	FB MCW Bit 15	0	2		0		771	0 = No action 1 = Fault low 2 = Fault high

Autorestart Parameters (Control Keypad: Menu M1 → G1.8)

Table 7-19: Autorestart Parameters — G1.8

Code	Parameter	Min.	Max.	Unit	Default	Cust	ID	Note
P1.8.1	Wait time	0.10	10.00	s	0.50		717	
P1.8.2	Trial time	0.00	60.00	s	30.00		718	
P1.8.3	Start mode	0	2		0		719	0 = Ramp 1 = Flying start 2 = Start per P1.4.6
P1.8.4	Number of tries after undervoltage trip	0	10		1		720	
P1.8.5	Number of tries after overvoltage trip	0	10		1		721	
P1.8.6	Number of tries after overcurrent trip	0	3		1		722	
P1.8.7	Number of tries after 4mA	0	10		1		723	
P1.8.8	Number of tries after motor temperature fault trip	0	10		1		726	
P1.8.9	Number of tries after external fault trip	0	10		0		725	
P1.8.10	Number of tries after underload fault trip	0	10		1		738	

August 2010

Pump and Fan Control Application

Pump and Fan Control Parameters (Control Keypad: Menu M1 → G1.9)

Table 7-20: Pump and Fan Control Parameters — G1.9

Code	Parameter	Min.	Max.	Unit	Default	Cust	ID	Note
P1.9.1	Number of auxiliary drives	0	4		0		1001	
P1.9.2	Start frequency. auxiliary drive 1	P1.9.3	320.00	Hz	61.00		1002	
P1.9.3	Stop frequency. auxiliary drive 1	P1.1.1	P1.9.2	Hz	10.00		1003	
P1.9.4	Start frequency. auxiliary drive 2	P1.9.5	320.00	Hz	61.00		1004	
P1.9.5	Stop frequency. auxiliary drive 2	P1.1.1	P1.9.4	Hz	10.00		1005	
P1.9.6	Start frequency. auxiliary drive 3	P1.9.7	320.00	Hz	61.00		1006	
P1.9.7	Stop frequency. auxiliary drive 3	P1.1.1	P1.9.6	Hz	10.00		1007	
P1.9.8	Start frequency. auxiliary drive 4	P1.9.9	320.00	Hz	61.00		1008	
P1.9.9	Stop frequency. auxiliary drive 4	P1.1.1	P1.9.8	Hz	10.00		1009	
P1.9.10	Start delay. auxiliary drives	0.0	300.0	s	4.0		1010	
P1.9.11	Stop delay. auxiliary drives	0.0	300.0	s	2.0		1011	
P1.9.12	Reference step. auxiliary drive 1	0.0	100.0	%	0.0		1012	
P1.9.13	Reference step. auxiliary drive 2	0.0	100.0	%	0.0		1013	
P1.9.14	Reference step. auxiliary drive 3	0.0	100.0	%	0.0		1014	
P1.9.15	Reference step. auxiliary drive 4	0.0	100.0	%	0.0		1015	
P1.9.16	PID controller bypass	0	1		0		1020	1 = PID contr. bypassed
P1.9.17	Analog input selection for input pressure measurement	0	5		0		1021	0 = Not used 1 = AI1 2 = AI2 3 = AI3 4 = AI4 5 = Fieldbus signal
P1.9.18	Input pressure high limit	0.0	100.0	%	30.00		1022	
P1.9.19	Input pressure low limit	0.0	100.0	%	20.00		1023	
P1.9.20	Output pressure drop	0.0	100.0	%	30.00		1024	
P1.9.21	Frequency drop delay	0.0	300.0	s	0.0		1025	0.0 = No delay 300.0 = No frequency drop

Pump and Fan Control Application

Table 7-20: Pump and Fan Control Parameters — G1.9 (Continued)

Code	Parameter	Min.	Max.	Unit	Default	Cust	ID	Note
P1.9.22	Frequency increase delay	0.0	300.0	s	0.0		1026	0.0 = No delay 300.0 = No frequency drop
P1.9.23	Interlock selection	0	2		0		1032	0 = Interlocks not used 1 = Set new interlock last; update order after value of P1.9.26 or Stop state 2 = Stop and update order immediately
P1.9.24	Autochange	0	1		0		1027	0 = Not used 1 = Autochange used
P1.9.25	Autochange and interlock automatics selection	0	1		0		1028	0 = Auxiliary drives only 1 = All drives
P1.9.26	Autochange interval	0.0	3000.0	h	48.0		1029	0.0 = TEST = 40 s
P1.9.27	Autochange; maximum number of auxiliary drives	0	4		1		1030	
P1.9.28	Autochange frequency limit	0.00	P1.1.2	Hz	30.00		1031	
P1.9.29	Actual value special display minimum	0.0	3000.0		0.0		1033	
P1.9.30	Actual value special display maximum	0.0	3000.0		10.0		1034	
P1.9.31	Actual value special display decimals	0	4		1		1035	

Keypad Control (Control Keypad: Menu M2)

This menu provides the parameters for the setting of the keypad frequency reference, the selection of motor direction when in keypad operation, and when the STOP button is active.

Table 7-21: Keypad Control Parameters — M2

Code	Parameter	Min.	Max.	Unit	Default	Cust	ID	Note
P2.1	Control place	0	2		0		1685	0 = Keypad L/R 1 = Local 2 = Remote 3 = I/O select
R2.1	Keypad reference	P1.1.1	P1.1.2	Hz				
P2.2	Direction (on keypad)	0	1		0		123	0 = Forward 1 = Reverse
P2.3	PID reference 1	0.00	100.00	%	0.00			
P2.4	PID reference 2	0.00	100.00	%	0.00			
P2.5	Stop button active	0	1		1		114	0 = Limited function of Stop button 1 = Stop button always enabled
P2.6	Operate menu hide	0	1	0				0 = No 1 = Yes

Pump and Fan Control Application

Menus — M3 to M6

Menus M3 to M6 provide information on the Active Faults, Fault History, System Menu settings and the Expander Board setup. These menu items are explained in detail in Chapter 5 of the *9000X AF Drives User Manual*.

Monitoring Menu — M7

The monitored items are the actual values of parameters and signals as well as the status and measurements of other elements. Monitored items cannot be edited.

See the *9000X AF Drives User Manual*, Chapter 5 — Menu information item M7, for more information.

Note: Local control is always frequency control mode unless PID is selected for the local reference. In remote, frequency mode is selected with DIN6 unless PID is selected for the remote reference. PC Control is always frequency mode.

August 2010

Chapter 8 — Description of Parameters

Introduction

On the following pages you will find the parameter descriptions arranged according to the individual ID number of the parameter. A parameter ID number with a ² footnote (e.g. **418² Motor potentiometer UP**) indicates that the *TTF programming method* shall be applied to this parameter (see **Page 6-3**).

Some parameter names are followed by a number code indicating the “All-in-One” applications in which the parameter is included. If **no code** is shown, the parameter is available in **all applications**. See the list of applications below. The parameter numbers under which the parameter appears in different applications are also given.

- 1 Basic Application
- 2 Standard Application
- 3 Local/Remote Control Application
- 4 Multi-Step Speed Control Application
- 5 PID Control Application
- 6 Multi-Purpose Control Application
- 7 Pump and Fan Control Application

101 Minimum frequency (P1.1, P1.1.1)

102 Maximum frequency (P1.2, P1.1.2)

Defines the frequency limits of the frequency converter. The maximum value for these parameters is 320 Hz. The software will automatically check the values of ID105, ID106, ID315 and ID728.

103 Acceleration time 1 (P1.3, P1.1.3)

104 Deceleration time 1 (P1.4, P1.1.4)

These limits correspond to the time required for the output frequency to accelerate from the zero frequency to the set maximum frequency (ID102).

105 Preset speed 1 **1246** (P1.18, P1.1.14, P1.1.15)

106 Preset speed 2 **1246** (P1.19, P1.1.15, P1.1.16)

Parameter values are automatically limited between the minimum and maximum frequencies (ID101, ID102). Note the use of the TTF-programming method in the Multi-Purpose Control Application. See ID419, ID420 and ID421.

Table 8-1: Preset Speed

Speed	Multi-step speed select 1 (DIN4)	Multi-step speed select 2 (DIN5)
Basic speed	0	0
ID105	1	0
ID106	0	1

Description of Parameters

107 Current limit (P1.5, P1.1.5)

This parameter determines the maximum motor current from the frequency converter. The parameter value range differs from size to size.

108 V/Hz ratio selection 234567 (P1.6.3)

Linear:

0 The voltage of the motor changes linearly with the frequency in the constant flux area from 0 Hz to the field weakening point where the nominal voltage is supplied to the motor. A linear V/Hz ratio should be used in constant torque applications. **This default setting should be used if there is no special need for another setting.**

Squared:

1 The voltage of the motor changes following a squared curve form with the frequency in the area from 0 Hz to the field weakening point where the nominal voltage is supplied to the motor. The motor runs under magnetized below the field weakening point and produces less torque and electromechanical noise. A squared V/Hz ratio can be used in applications where the torque demand of the load is proportional to the square of the speed, e.g. in centrifugal fans and pumps.

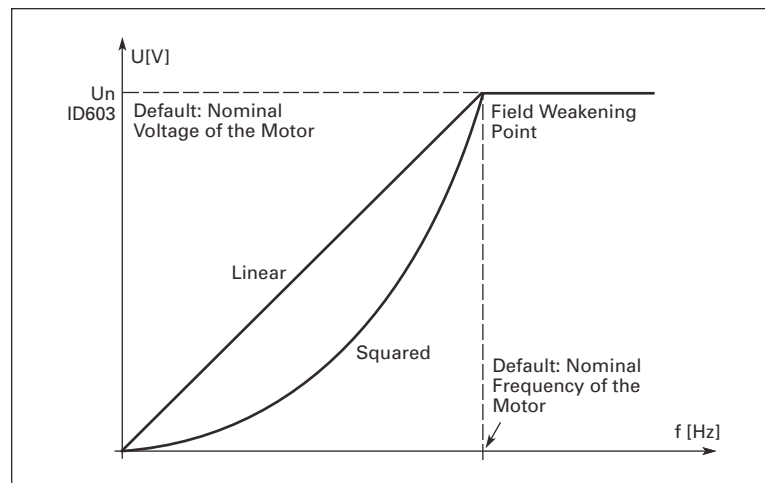

Figure 8-1: Linear and Squared Change of Motor Voltage

Programmable V/Hz curve:

2 The V/Hz curve can be programmed with three different points. A programmable V/Hz curve can be used if the other settings do not satisfy the needs of the application.

Description of Parameters

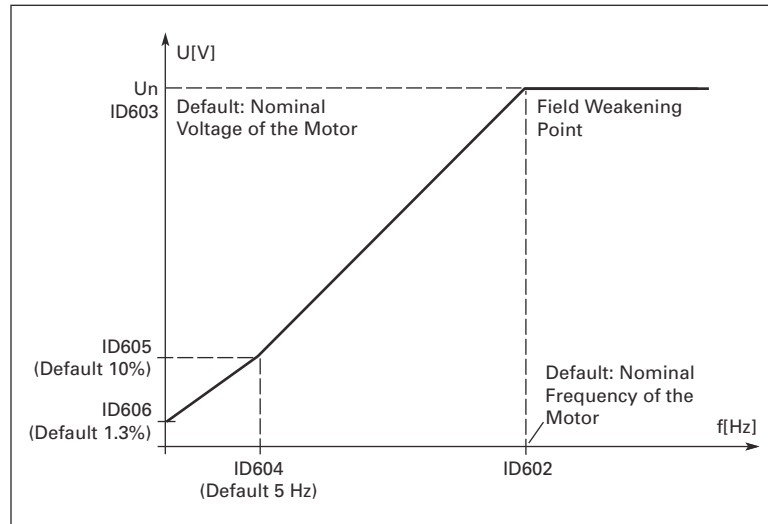

Figure 8-2: Programmable V/Hz Curve

Linear with flux optimization:

- 3** The frequency converter starts to search for the minimum motor current in order to save energy, lower the disturbance level and the noise. This function can be used in applications with constant motor load, such as fans, pumps, etc.

109 V/Hz optimization (P1.13, P1.6.2)

Automatic torque boost The voltage to the motor changes automatically which makes the motor produce sufficient torque to start and run at low frequencies. The voltage increase depends on the motor type and power. Automatic torque boost can be used in applications where starting torque due to starting friction is high, e.g. in conveyors.

Example:

What changes are required to start the load from 0 Hz?

- First set the motor nominal values (Parameter group 1.1).

Option 1: Activate the Automatic torque boost.

Option 2: Programmable V/Hz curve

To obtain the required torque, the zero point voltage and midpoint voltage/frequency (in parameter group 1.6) need to be set, so that the motor can draw enough current at the low frequencies. First set parameter ID108 to *Programmable V/Hz curve* (value **2**). Increase the zero point voltage (ID606) to get enough current at zero speed. Then set the midpoint voltage (ID605) to $1.4142 \cdot ID606$ and the midpoint frequency (ID604) to value $ID606/100\% \cdot ID111$.

Note: In high torque — low speed applications — it is likely that the motor will overheat. If the motor has to run a prolonged time under these conditions, special attention must be paid to cooling the motor. Use external cooling for the motor if the temperature tends to rise too high.

Description of Parameters

- 110 Nominal voltage of the motor** (P1.6, P1.1.6)
Find this value V_n on the rating plate of the motor. This parameter sets the voltage at the field weakening point (ID603) to $100\% * V_{nMotor}$.
- 111 Nominal frequency of the motor** (P1.7, P1.1.7)
Find this value f_n on the rating plate of the motor. This parameter sets the field weakening point (ID602) to the same value.
- 112 Nominal speed of the motor** (P1.8, P1.1.8)
Find this value n_n on the rating plate of the motor.
- 113 Nominal current of the motor** (P1.9, P1.1.9)
Find this value I_n on the rating plate of the motor.
- 118 PID controller gain** **57** (P1.1.12)
This parameter defines the gain of the PID controller. If the value of the parameter is set to 100% a change of 10% in the error value causes the controller output to change by 10%. If the parameter value is set to 0 the PID controller operates as ID-controller. See the examples on **Page 8-5**.
- 119 PID controller I-time** **57** (P1.1.13)
ID119 defines the integration time of the PID controller. If this parameter is set to 1.00 second, a change of 10% in the error value causes the controller output to change by 10.00%/s. If the parameter value is set to 0.00 s the PID controller will operate as PD controller. See the examples on **Page 8-5**.
- 120 Motor Power Factor** (P1.10, P1.1.10)
Find this value "Power Factor" on the rating plate of the motor.
- 124 Jogging speed reference** **34567** (P1.1.14, P1.1.15, P1.1.19)
Defines the jogging speed selected with the DIN3 digital input which can be programmed for Jogging speed. See parameter ID301.
This parameter's value is automatically limited between minimum and maximum frequency (ID101 and ID102).
- 126 Preset speed 3** **46** (P1.1.17)
127 Preset speed 4 **46** (P1.1.18)
128 Preset speed 5 **46** (P1.1.19)
129 Preset speed 6 **46** (P1.1.20)
130 Preset speed 7 **46** (P1.1.21)
These parameter values define the Multi-step speeds selected with the DIN3, DIN4, DIN5 and DIN6 digital inputs. See also parameters ID105 and ID106.
These parameter values are automatically limited between minimum and maximum frequency (ID101 and ID102).

Description of Parameters

Table 8-2: Preset Speeds 3 to 7

Speed	Multi-step speed select 1 (DIN4)	Multi-step speed select 2 (DIN5)	Multi-step speed select 3 (DIN6)	Multi-step speed select 4 (DIN3)
Basic speed	0	0	0	0
P1.1.17 (3)	1	1	0	0
P1.1.18 (4)	0	0	1	0
P1.1.19 (5)	1	0	1	0
P1.1.20 (6)	0	1	1	0
P1.1.21 (7)	1	1	1	0

132 PID controller D-time 57 (P1.1.14)

ID132 defines the derivative time of the PID controller. If this parameter is set to 1.00 second a change of 10% in the error value during 1.00 s causes the controller output to change by 10.00%. If the parameter value is set to 0.00 s the PID controller will operate as PI controller. See examples below.

Example 1:

In order to reduce the error value to zero, with the given values, the frequency converter output behaves as follows:

Given values:

P1.1.12, P = 0%

P1.1.13, I-time = 1.00 s

P1.1.14, D-time = 0.00 s

Error value (setpoint – process value) = 10.00%

Min freq. = 0 Hz

Max freq. = 60 Hz

In this example, the PID controller operates practically as an I-controller only. According to the given value of P1.1.13 (I-time), the PID output increases by 5 Hz (10% of the difference between the maximum and minimum frequency) every second until the error value is 0.

Description of Parameters

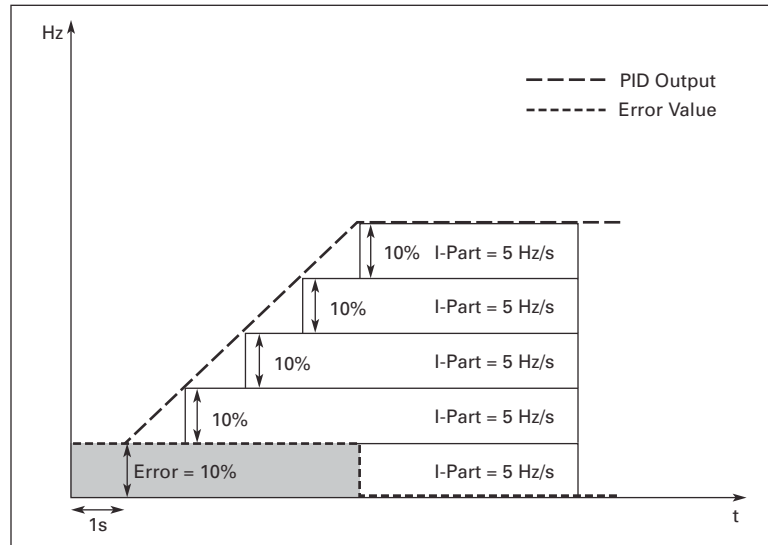

Figure 8-3: PID Controller Function as I-Controller

Example 2:

Given values:

P1.1.12, P = 100%

P1.1.13, I-time = 1.00 s

P1.1.14, D-time = 1.00 s

Error value (setpoint – process value) = ±10%

Min freq. = 0 Hz

Max freq. = 60 Hz

As the power is switched on, the system detects the difference between the setpoint and the actual process value and starts to either raise or decrease (in case the error value is negative) the PID output according to the I-time. Once the difference between the setpoint and the process value has been reduced to 0, the output is reduced by the amount corresponding to the value of P1.1.13.

In case the error value is negative, the frequency converter reacts reducing the output correspondingly. See **Figure 8-4**.

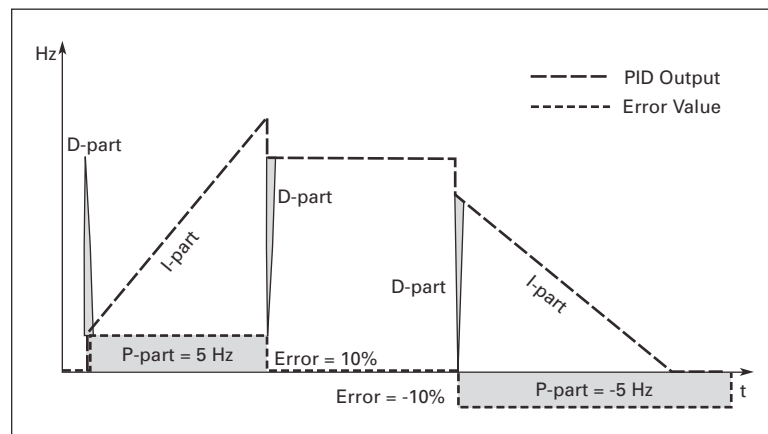

Figure 8-4: PID Output Curve with the Values of Example 2

Description of Parameters

Example 3:

Given values:

P1.1.12, P = 100%

P1.1.13, I-time = 0.00 s

P1.1.14, D-time = 1.00 s

Error value (setpoint – process value) = ±10%/s

Min freq. = 0 Hz

Max freq. = 60 Hz

As the error value increases, the PID output also increases according to the set values (D-time = 1.00s)

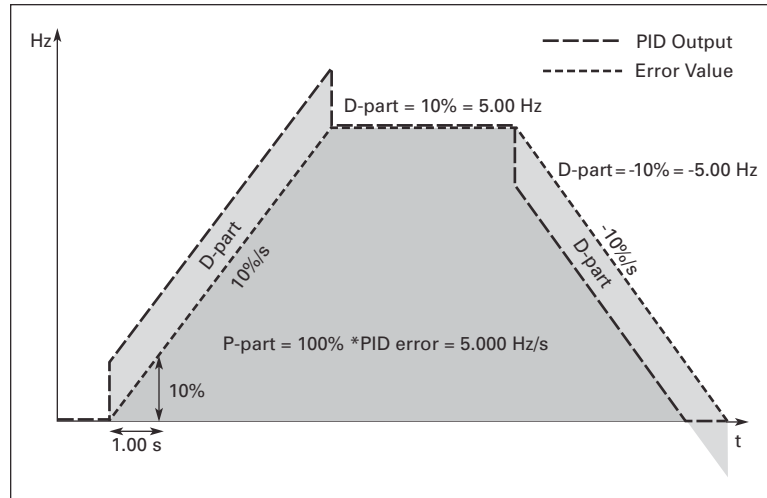

Figure 8-5: PID Output Curve with the Values of Example 3

133	Preset speed 8	4	(P1.1.22)
134	Preset speed 9	4	(P1.1.23)
135	Preset speed 10	4	(P1.1.24)
136	Preset speed 11	4	(P1.1.25)
137	Preset speed 12	4	(P1.1.26)
138	Preset speed 13	4	(P1.1.27)
139	Preset speed 14	4	(P1.1.28)
140	Preset speed 15	4	(P1.1.29)

Table 8-3: Multi-Step Speed Selections with Digital Inputs DIN3, DIN4, DIN5 and DIN6

Speed	Multi-step speed select 1 (DIN4)	Multi-step speed select 2 (DIN5)	Multi-step speed select 3 (DIN6)	Multi-step speed select 4 (DIN3)
P1.1.22 (8)	0	0	0	1
P1.1.23 (9)	1	0	0	1
P1.1.24 (10)	0	1	0	1
P1.1.25 (11)	1	1	0	1
P1.1.26 (12)	0	0	1	1
P1.1.27 (13)	1	0	1	1
P1.1.28 (14)	0	1	1	1
P1.1.29 (15)	1	1	1	1

Description of Parameters

141 [Ⓢ] **AI3 signal selection** **567** (P1.2.38, P1.2.4.1)
Connect the AI3 signal to the analog input of your choice with this parameter. For more information, see **Page 6-3**, "Terminal to Function" (TTF) programming principle.

142 **AI3 signal filter time** **567** (P1.2.41, P1.2.4.2)
When this parameter is given a value greater than 0, the function that filters out disturbances from the incoming analog signal is activated. A long filtering time makes the regulation response slower. See ID324.

143 **AI3 signal range** **567** (P1.2.39, P1.2.4.3)
With this parameter you can select the AI3 signal range.

Table 8-4: Selections for ID143

Application			
Select	5	6	7
0	0 – 100%	0 – 100%	0 – 100%
1	20 – 100%	20 – 100%	20 – 100%
2	—	-10 – +10V	Customized
3	—	Customized	

144 **AI3 custom setting minimum** **67** (P1.2.4.4)

145 **AI3 custom setting maximum** **67** (P1.2.4.5)

Set the custom minimum and maximum levels for the AI3 signal from 0 to 100%.

151 **AI3 signal inversion** **567** (P1.2.40, P1.2.4.6)
0 = No inversion
1 = Signal inverted

152 [Ⓢ] **AI4 signal selection** **567** (P1.2.42, P1.2.5.1)
See ID141.

153 **AI4 filter time** **567** (P1.2.45, P1.2.5.2)
See ID142.

154 **AI4 signal range** **567** (P1.2.43, P1.2.5.3)
See ID143.

155 **AI4 custom setting minimum** **67** (P1.2.5.4)

156 **AI4 custom setting maximum** **67** (P1.2.5.5)

See ID144 and ID145.

162 **AI4 signal inversion** **567** (P1.2.44, P1.2.5.6)
See ID151.

Description of Parameters

164 [Ⓢ] **Motor control mode 1/2** **6** (P1.2.7.22)

Contact is open = Motor control mode 1 is selected.
 Contact is closed = Motor control mode 2 is selected.
 See ID600 and ID521.

165 **AI1 joystick offset** **6** (P1.2.2.11)

Define the frequency zero point as follows: With this parameter being displayed, place the potentiometer at the assumed zero point and press ENTER on the keypad. **Note:** This will not change the reference scaling. Press the RESET button to change the parameter value back to 0.00%.

166 **AI2 joystick offset** **6** (P1.2.3.11)

See ID165.

169 **Fieldbus input data 4** **6** (P1.3.3.27)
(FBFixedControlWord, bit 6)

170 **Fieldbus input data 5** **6** (P1.3.3.28)
(FBFixedControlWord, bit 7)



The data from the fieldbus (FBFixedControlWord) can be led to the digital outputs of the frequency converter.

171 **Local & Remote Control Place**
&172

The active control place can be changed by pressing the LOC/REM button on the keypad.

There are two different places which the frequency converter can be controlled from, Local and Remote. For each control place the actual control source is selected with this parameter, a different symbol will appear on the alphanumeric display:

Table 8-5: Selections for ID171 and ID172

Control source	Symbol
I/O terminals	
Keypad (panel)	
Fieldbus	

173 **Local & Remote reference** **234567**
&174 **selection**

Defines which frequency reference source is selected when controlled from the keypad.

Description of Parameters

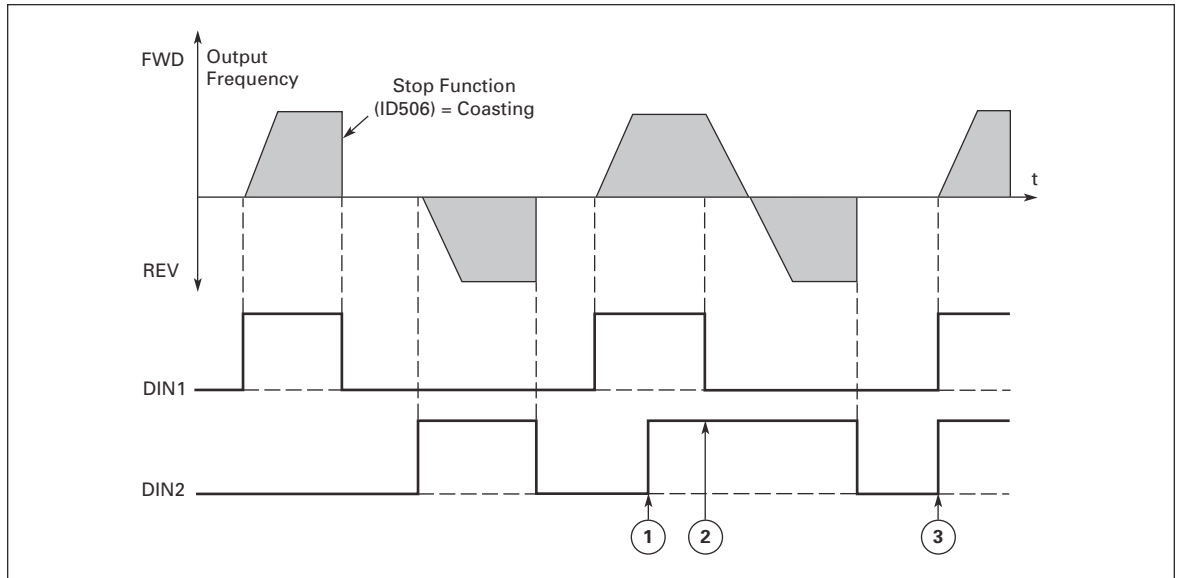

Figure 8-6: Start Forward/Start Reverse

- ① The first selected direction has the highest priority.
- ② When the DIN1 contact opens the direction of rotation starts to change.
- ③ If Start forward (DIN1) and Start reverse (DIN2) signals are active simultaneously the Start forward signal (DIN1) has priority.

1 DIN1: closed contact = start — open contact = stop
 DIN2: closed contact = reverse — open contact = forward, see **Figure 8-7**.

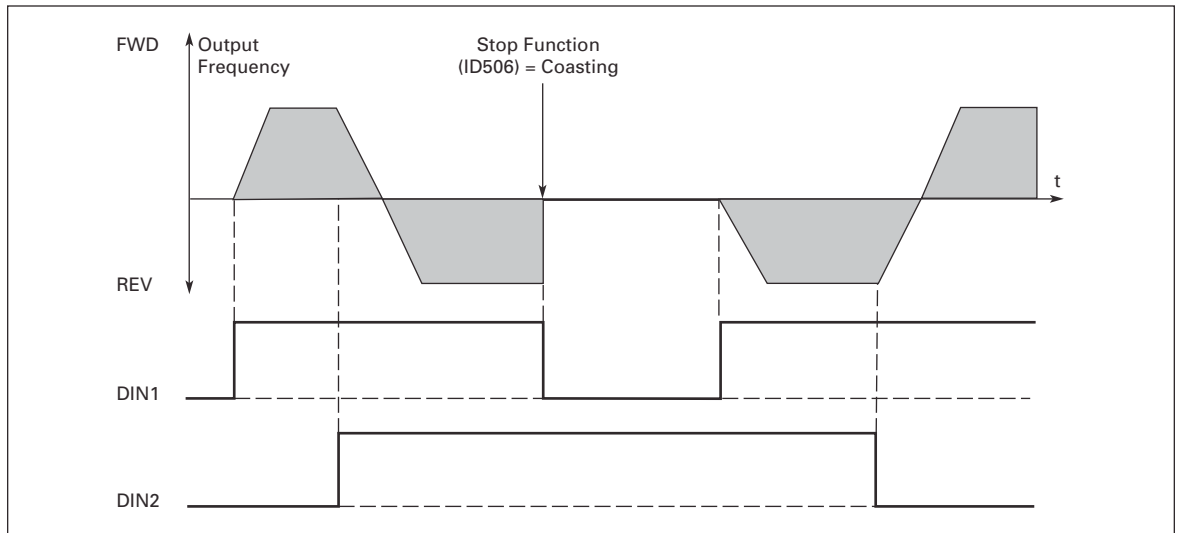

Figure 8-7: Start, Stop and Reverse

Description of Parameters

- 2** DIN1: closed contact = start — open contact = stop
 DIN2: closed contact = start enabled — open contact = start disabled and drive stopped if running, see **Figure 8-8**.
- 3** 3-wire connection (pulse control):
 DIN1: closed contact = start pulse
 DIN2: open contact = stop pulse
 (DIN3 can be programmed for reverse command), see **Figure 8-8**.

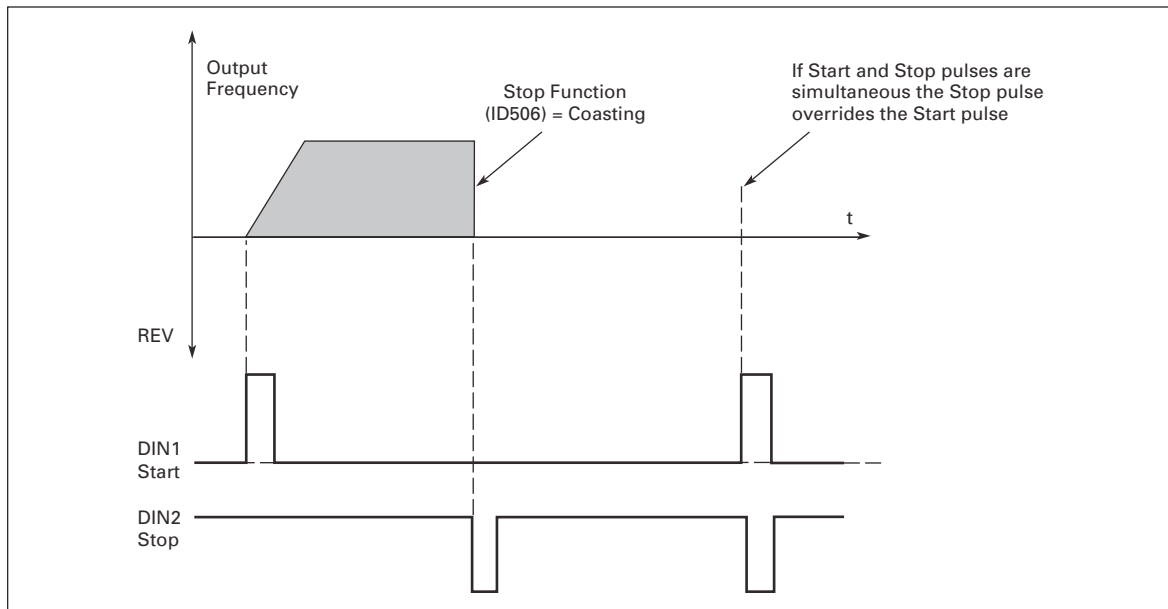

Figure 8-8: Start Pulse/Stop Pulse

Description of Parameters

The selections including the text **“Rising edge required to start”** shall be used to exclude the possibility of an unintentional start when, for example, power is connected, re-connected after a power failure, after a fault reset, after the drive is stopped by Run Enable (Run Enable = False) or when the control place is changed. The Start/Stop contact must be opened before the motor can be started.

Applications 2 and 4:

- 4 DIN1: closed contact = start forward (**Rising edge required to start**)
 DIN2: closed contact = start reverse (**Rising edge required to start**)
- 5 DIN1: closed contact = start (**Rising edge required to start**)
 open contact = stop
 DIN2: closed contact = reverse — open contact = forward
- 6 DIN1: closed contact = start (**Rising edge required to start**)
 open contact = stop
 DIN2: closed contact = start enabled — open contact = start disabled and
 drive stopped if running

Application 3 and 6:

- 4 DIN1: closed contact = start forward
 DIN2: closed contact = reference increases (motor potentiometer
 reference; this parameter is automatically set to 4 if ID174 is set to 3 or 4).
- 5 DIN1: closed contact = start forward (**Rising edge required to start**)
 DIN2: closed contact = start reverse (**Rising edge required to start**)
- 6 DIN1: closed contact = start (**Rising edge required to start**)
 open contact = stop
 DIN2: closed contact = reverse — open contact = forward
- 7 DIN1: closed contact = start (**Rising edge required to start**)
 open contact = stop
 DIN2: closed contact = start enabled — open contact = start disabled and
 drive stopped if running

Application 3:

- 8 DIN1: closed contact = start forward (**Rising edge required to start**)
 DIN2: closed contact = reference increases (motor potentiometer
 reference; this parameter is automatically set to 4 if ID174 is set to 3 or 4).

Description of Parameters

301 DIN3 function **12345** (P1.17, P1.2.2)

- 0** Not used
- 1** External fault, closing contact = Fault is shown and motor is stopped when the input is active
- 2** External fault, opening contact = Fault is shown and motor is stopped when the input is not active
- 3** Run enable:
contact open = Motor start disabled and the motor is stopped
contact closed = Motor start enabled

Application 1:

- 4** Run enable:
contact open = Motor start enabled
contact closed = Motor start disabled and the motor is stopped

Applications 2 to 5:

- 4** Acc./Dec. time select:
contact open = Acceleration/deceleration time 1 selected
contact closed = Acceleration/deceleration time 2 selected
- 5** Closing contact: Force control place to I/O terminal
- 6** Closing contact: Force control place to keypad
- 7** Closing contact: Force control place to fieldbus

When the control place is forced to change, the values of Start/Stop, Direction and Reference valid in the respective control place are used (reference according to parameters ID173 and ID174).

Note: The value of ID125 Keypad Control Place does not change. When DIN3 opens the control place is selected according to parameter 3.1.

Applications 2 to 5:

- 8** Reverse:
contact open = Forward
contact closed = Reverse
Note: Can be used for reversing if ID300 has a value of 3.

Applications 3 to 5:

- 9** Jogging speed, contact closed = Jogging speed selected for frequency reference
- 10** Fault reset, contact closed = Resets all faults
- 11** Acc./dec. operation prohibited, contact closed = Stops acceleration or deceleration until the contact is opened
- 12** DC-braking command, contact closed = In Stop mode, the DC-braking operates until the contact is opened, see **Figure 8-9**.

Applications 3 and 5:

- 13** Motor potentiometer down, contact closed = Reference decreases until the contact is opened

Application 4:

- 13** Preset speed

Description of Parameters

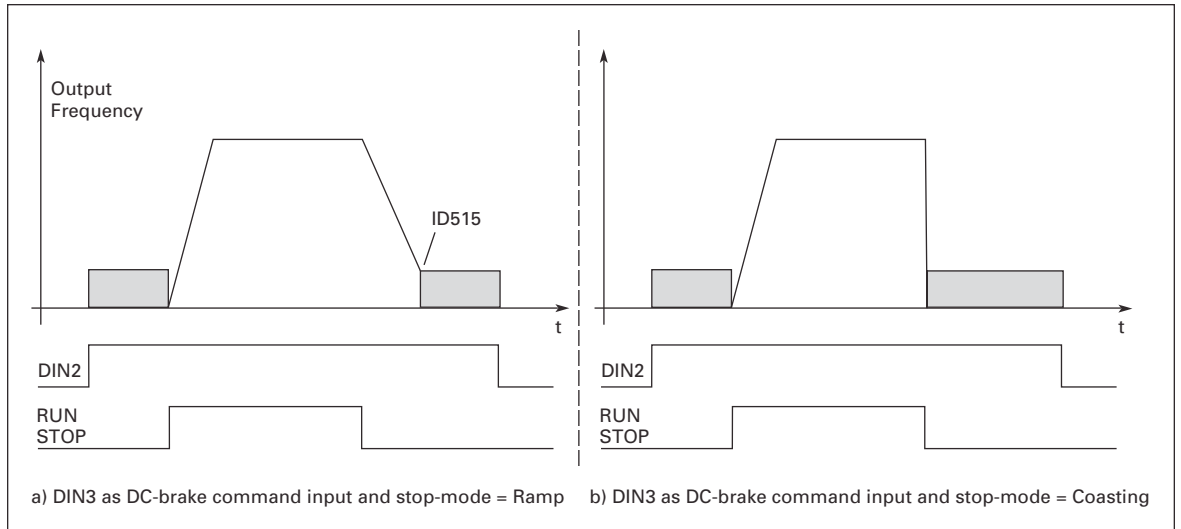

Figure 8-9: DIN3 as DC-Brake Command Input
a) Stop mode = ramp, b) Stop mode = coasting

- 302 Reference offset for current input** **12** (P1.15, P1.2.3)
- 0** No offset: 0 – 20 mA
- 1** Offset: 4 mA (“living zero”) provides supervision of zero level signal. In the Standard Application, the response to reference fault can be programmed with ID700.

- 303 Reference scaling, minimum value** **2346** (P1.2.4, P1.2.16, P1.2.2.6)
- 304 Reference scaling, maximum value** **2346** (P1.2.5, P1.2.17, P1.2.2.7)

Setting value limits: $0 \leq ID303 \leq ID304 \leq ID102$. If $ID303 = 0$ scaling is set off. The minimum and maximum frequencies are used for scaling.

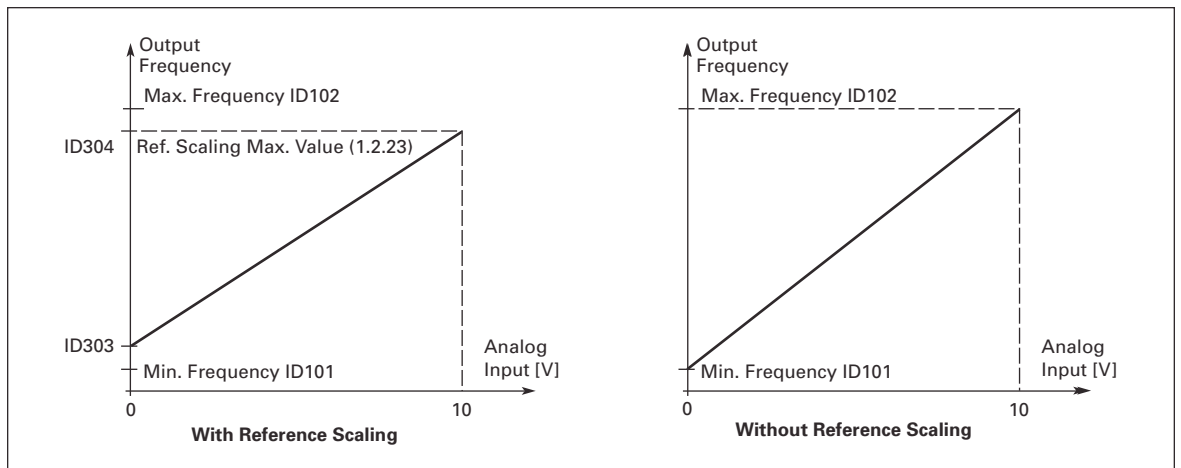

Figure 8-10: With and Without Reference Scaling
Left: Reference scaling, Right: No scaling used (ID303 = 0)

Description of Parameters

305 Reference inversion 2 (P1.2.6)

Inverts reference signal: Max. ref. signal = Min. set freq.
Min. ref. signal = Max. set freq.

- 0 No inversion
- 1 Reference inverted

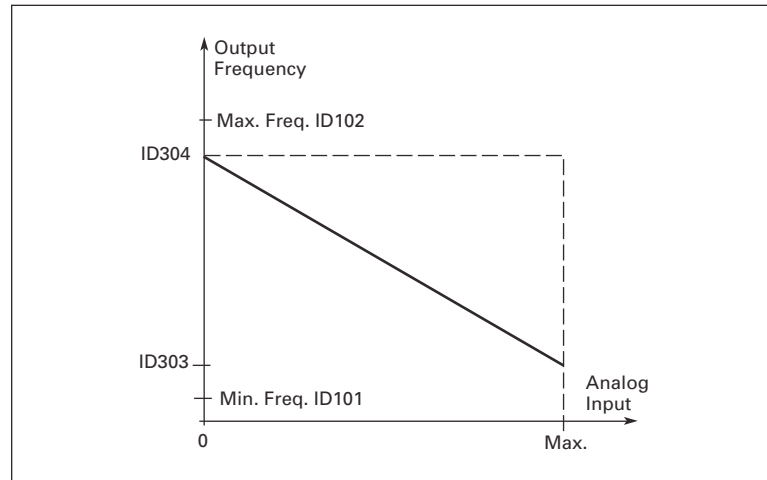

Figure 8-11: Reference Inversion

306 Reference filter time 2 (P1.2.7)

Filters out disturbances from the incoming analog V_{in} signal. A long filtering time makes regulation response slower.

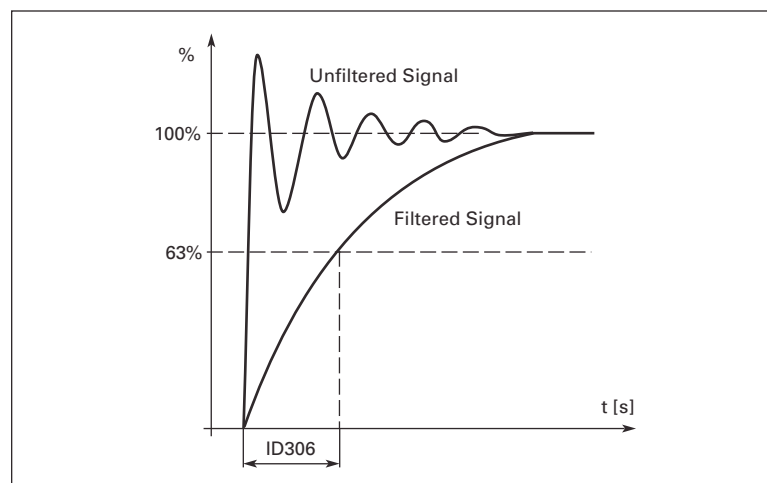

Figure 8-12: Reference Filtering

307 Analog output function (P1.16, P1.3.2, P1.3.5.2, P1.3.3.2)

This parameter selects the desired function for the analog output signal. See the specific parameters for the values available in each respective application.

Description of Parameters

308 Analog output filter time 234567 (P1.3.3, P1.3.5.3, P1.3.3.3)

Defines the filtering time for the analog output signal. Setting this parameter value to **0.00** will deactivate filtering.

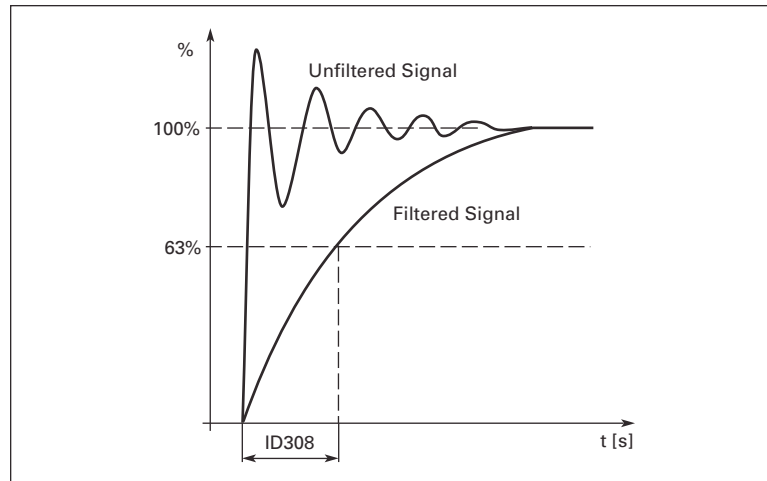

Figure 8-13: Analog Output Filtering

309 Analog output inversion 234567 (P1.3.4, P1.3.5.4, P1.3.3.4)

Inverts the analog output signal:

Maximum output signal = Minimum set value

Minimum output signal = Maximum set value

See ID311 in **Figure 8-14**.

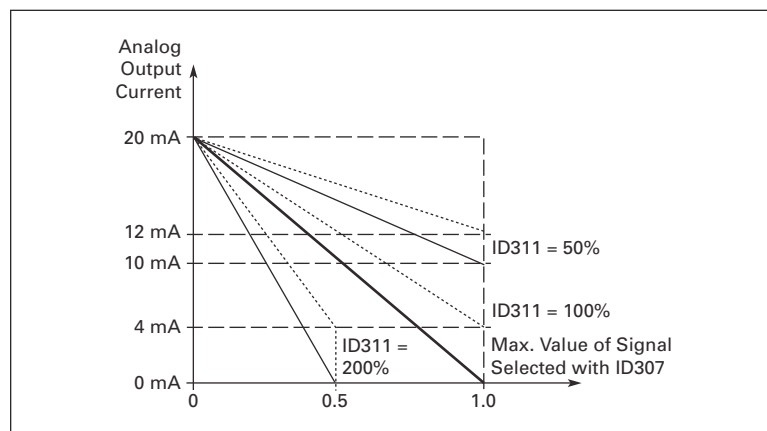

Figure 8-14: Analog Output Invert

310 Analog output minimum 234567 (P1.3.5, P1.3.5.5, P1.3.3.5)

Defines the signal minimum to be either 0 mA or 4 mA (“living zero”). Note the difference in analog output scaling in ID311 (**Figure 8-15**).

0 Set minimum value to 0 mA

1 Set minimum value to 4 mA

Description of Parameters

311 Analog output scale 234567 (P1.3.6, P1.3.5.6, P1.3.3.6)

Scaling factor for analog output.

Table 8-7: Analog Output Scaling

Signal	Max. value of the signal
Output frequency	Max frequency (ID102)
Freq. Reference	Max frequency (ID102)
Motor speed	Motor nom. speed $1 \times n_{mMotor}$
Output current	Motor nom. current $1 \times I_{nMotor}$
Motor torque	Motor nom. torque $1 \times T_{nMotor}$
Motor power	Motor nom. power $1 \times P_{nMotor}$
Motor voltage	$100\% \times V_{nMotor}$
DC-link voltage	1000 V
PI-ref. value	$100\% \times \text{ref. value max.}$
PI act. value 1	$100\% \times \text{actual value max.}$
PI act. value 2	$100\% \times \text{actual value max.}$
PI error value	$100\% \times \text{error value max.}$
PI output	$100\% \times \text{output max.}$

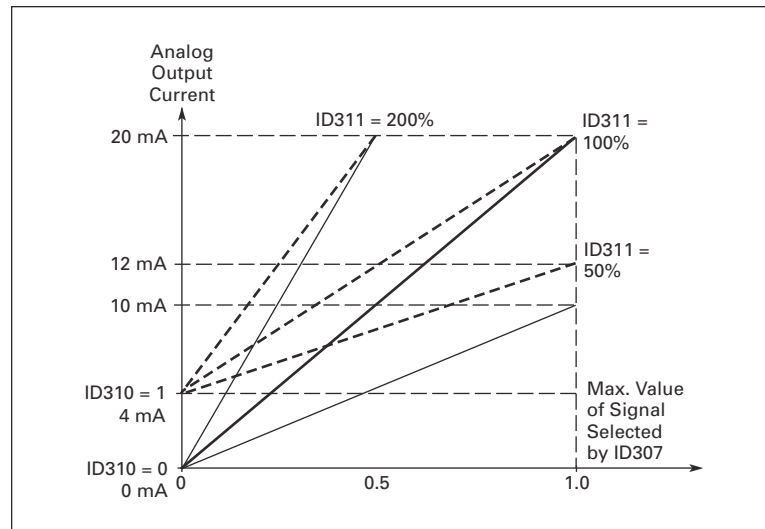

Figure 8-15: Analog Output Scaling

- 312 Digital output function 23456 (P1.3.7, P1.3.1.2)
 313 Relay output 1 function 2345 (P1.3.8, P1.3.1.3)
 314 Relay output 2 function 2345 (P1.3.9)

Description of Parameters

Table 8-8: Output Signals Via DO1 and Output Relays RO1 and RO2

Setting value	Signal content
0 = Not used	Out of operation
Digital output DO1 sinks current and programmable relay (RO1, RO2) is activated when:	
1 = Ready	The frequency converter is ready to operate
2 = Run	The frequency converter is operating (motor is running)
3 = Fault	A fault trip has occurred
4 = Fault inverted	A fault trip <u>not</u> occurred
5 = Overheat warning	The heat-sink temperature exceeds +70°C
6 = External fault or warning	Fault or warning depending on ID701
7 = Reference fault or warning	Fault or warning depending on ID700 • if analog reference is 4 – 20 mA and signal is <4 mA
8 = Warning	Always if a warning exists
9 = Reversed	The reverse command has been selected
10 = Preset speed 1 (Application 2) 10 = Jogging speed (Applications 3456)	The preset speed has been selected with digital input The jogging speed has been selected with digital input
11 = At speed	The output frequency has reached the set reference
12 = Motor regulator activated	Overvoltage or overcurrent regulator was activated
13 = Output frequency limit supervision	The output frequency is outside the set supervision low limit/high limit (ID315 and ID316)
14 = Control from I/O terminals (Application 2) 14 = Output frequency limit 2 supervision (Applications 3456)	I/O control mode selected (in menu M2) The output frequency goes outside the set supervision low limit/high limit (ID346 and ID347)
15 = Thermistor fault or warning (Application 2) 15 = Torque limit supervision (Applications 3456)	The thermistor input of option board indicates overtemperature. Fault or warning depending on ID732. The motor torque is beyond the set supervision low limit/high limit (ID348 and ID349).
16 = Fieldbus input data (Application 2) 16 = Reference limit supervision (Applications 3456)	Fieldbus input data (FBFixedControlWord) to DO/RO. Active reference goes beyond the set supervision low limit/high limit (ID350 and ID351)
17 = External brake control (Applications 3456)	External brake ON/OFF control with programmable delay (ID352 and ID353)
18 = Control from I/O terminals (Applications 3456)	External control mode (Menu M2; ID125)
19 = Frequency converter temperature limit supervision (Applications 3456)	Frequency converter heatsink temperature goes beyond the set supervision limits (ID354 and ID355).
20 = Unrequested rotation direction (Applications 345) 20 = Reference inverted (Application 6)	Rotation direction is different from the requested one.
21 = External brake control inverted (Applications 3456)	External brake ON/OFF control (ID352 and ID353); Output active when brake control is OFF

Description of Parameters

Table 8-8: Output Signals Via DO1 and Output Relays RO1 and RO2, (Continued)

Setting value	Signal content
22 = Thermistor fault or warning (Applications 3456)	The thermistor input of option board indicates overtemperature. Fault or warning depending on ID732.
23 = Fieldbus input data (Application 5) 23 = On/Off control (Application 6)	Fieldbus input data (FBFixedControlWord) to DO/RO. Selects the analog input to be monitored. (ID356, ID357, ID358 and ID463)
24 = Fieldbus input data 1 (Application 6)	Fieldbus data (FBFixedControlWord) to DO/RO
25 = Fieldbus input data 2 (Application 6)	Fieldbus data (FBFixedControlWord) to DO/RO
26 = Fieldbus input data 3 (Application 6)	Fieldbus data (FBFixedControlWord) to DO/RO

315 Output frequency limit supervision function **234567** (P1.3.10, P1.3.4.1, P1.3.2.1)

- 0** No supervision
- 1** Low limit supervision
- 2** High limit supervision
- 3** Brake-on control (Application **6** only, see **Page A-1.**)

If the output frequency goes under/over the set limit (ID316) this function generates a warning message via the digital output DO1 or via the relay outputs RO1 or RO2 depending on the settings of ID312 to ID314.

316 Output frequency limit supervision value **234567** (P1.3.11, P1.3.4.2, P1.3.2.2)

Selects the frequency value supervised by ID315. See **Figure 8-16.**

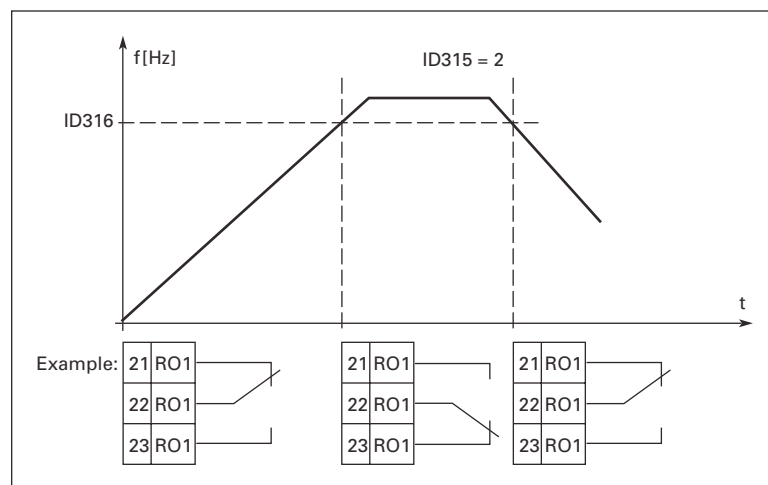

Figure 8-16: Output Frequency Supervision

Description of Parameters

319 DIN2 function 5 (P1.2.1)

This parameter has 14 selections. If digital input DIN2 is not used, set this value to **0**.

- | | |
|-----------|--|
| 0 | Not used |
| 1 | External fault:
Contact closed = Fault is displayed and the motor stopped when the input is active |
| 2 | External fault:
Contact open = Fault is displayed and the motor stopped when the input is not active |
| 3 | Run enable:
Contact open = Start of motor disabled
Contact closed = Start of motor enabled |
| 4 | Acceleration or deceleration time selection:
Contact open = Acceleration/Deceleration time 1 selected
Contact closed = Acceleration/Deceleration time 2 selected |
| 5 | Closing contact: Force control place to I/O terminal |
| 6 | Closing contact: Force control place to keypad |
| 7 | Closing contact: Force control place to fieldbus
When the control place is forced to change, the values of Start/Stop, Direction and the Reference valid in the respective control place, are used (reference according to ID343, ID121 and ID122).
Note: The value of ID125 (Keypad Control Place) does not change. When DIN2 opens the control place is selected according to keypad control place selection. |
| 8 | Reverse:
Contact open = Forward
Contact closed = Reverse
Note: If several inputs are programmed to reverse, one active contact is enough to set the direction to reverse. |
| 9 | Jog speed (see ID124)
Contact closed = Jogging speed selected for frequency reference |
| 10 | Fault reset
Contact closed = All faults reset |
| 11 | Acceleration/Deceleration prohibited:
Contact closed = No acceleration or deceleration possible until the contact is opened |
| 12 | DC braking command:
Contact closed = In Stop mode, the DC braking operates until the contact is opened. See Figure 8-17 . |
| 13 | Motor potentiometer UP:
Contact closed = Reference increases until the contact is opened. |

Description of Parameters

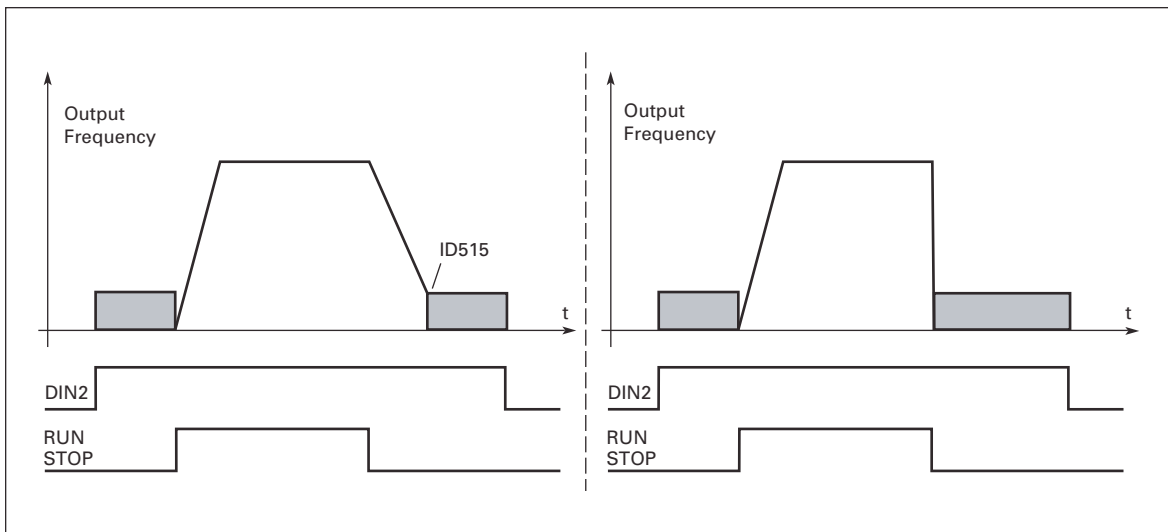

Figure 8-17: DC Braking Command (Selection 12) Selected for DIN2
Left: Stop mode = ramp, Right: Stop mode = coasting

320 AI1 signal range **34567** (P1.2.4, P1.2.16, P1.2.2.3)

Table 8-9: Selections for ID320

Application			
Select	3, 4, 5	6	7
0	0 – 100%	0 – 100%	0 – 100%
1	20 – 100%	20 – 100%	20 – 100%
2	Customized	-10 – +10V	Customized
3	—	Customized	—

For selection “Customized”, see ID321 and ID322.

321 AI1 custom setting minimum **34567** (P1.2.5, P1.2.17, P1.2.2.4)

322 AI1 custom setting maximum **34567** (P1.2.6, P1.2.18, P1.2.2.5)

These parameters set the analog input signal for any input signal span within 0 – 100%.

Description of Parameters

323 AI1 signal inversion 3457 (P1.2.7, P1.2.19, P1.2.2.6)

If this parameter = **0** no inversion of analog V_{in} signal takes place.

Note: In Application 3, AI1 is place B frequency reference if parameter ID131 = 0 (default).

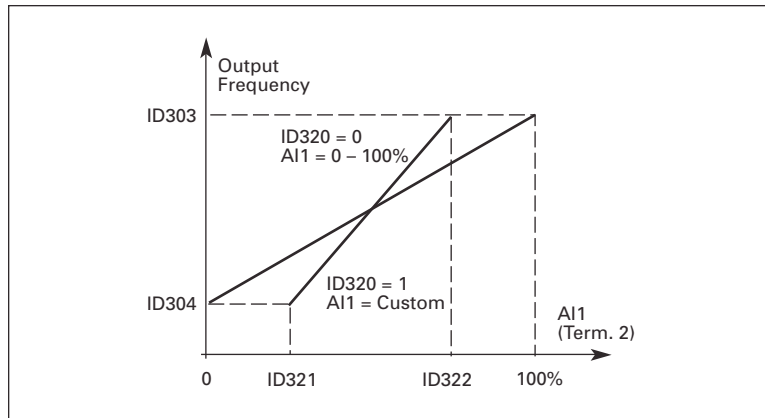

Figure 8-18: AI1 No Signal Inversion

If this parameter = **1** inversion of analog signal takes place.

max. AI1 signal = minimum set speed

min. AI1 signal = maximum set speed

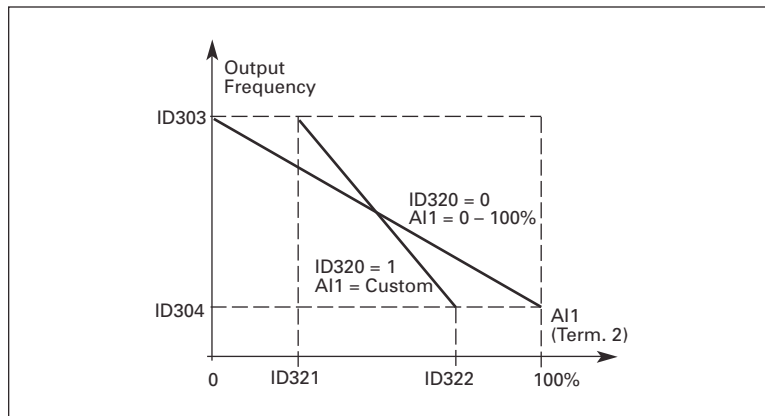

Figure 8-19: AI1 Signal Inversion

Description of Parameters

324 AI1 signal filter time 34567 (P1.2.8, P1.2.20, P1.2.2.2)

When this parameter is given a value greater than 0, the function that filters out disturbances from the incoming analog signal is activated.

A long filtering time makes the regulation response slower. See **Figure 8-20**.

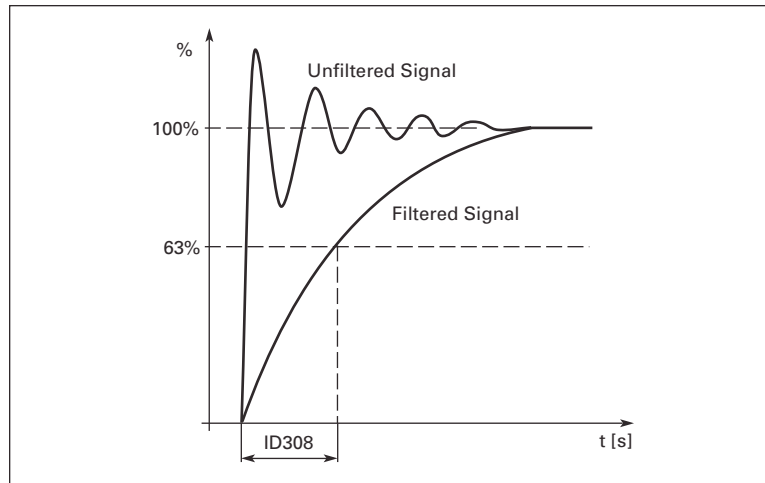

Figure 8-20: AI1 Signal Filtering

325 Analog input AI2 signal range 34567 (P1.2.10, P1.2.22, P1.2.3.3)

Table 8-10: Selections for Parameter ID325

Application	3, 4	5	6	7
Select				
0	0 – 20 mA	0 – 20 mA	0 – 100%	0 – 100%
1	4 – 20 mA	4 mA/ 20 – 100%	20 – 100%	20 – 100%
2	Customized	Customized	-10 – +10V	Customized
3	—	—	Customized	—

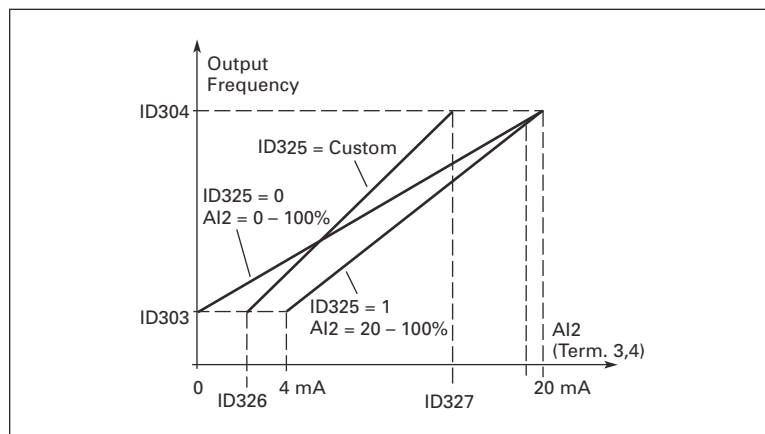

Figure 8-21: Analog Input AI2 Scaling

Description of Parameters

- 326 Analog input AI2 custom setting min.** **34567** (P1.2.11, P1.2.23, P1.2.3.4)
- 327 Analog input AI2 custom setting max.** **34567** (P1.2.12, P1.2.24, P1.2.3.5)

These parameters set AI2 for any input signal span within 0 – 100%.

- 328 Analog input AI2 inversion** **3457** (P1.2.13, P1.2.25, P1.2.3.6)
- See ID323.

Note: In Application 3, AI2 is the place A frequency reference, if ID117 = 1 (default)

- 329 Analog input AI2 (I_{in}) filter time** **34567** (P1.2.14, P1.2.25, P1.2.3.2)
- See ID324.

- 330 DIN5 function** **5** (P1.2.3)

The digital input DIN5 has 14 possible functions. If it is not used, set the value to **0**. The selections are the same as in ID319 except:

- 13** Enable PID reference 2:
 Contact open = PID controller reference selected with ID332
 Contact closed = PID controller keypad reference 2 selected with parameter R3.5

- 331 Motor potentiometer ramp time** **3567** (P1.2.22, P1.2.27, P1.2.1.2, P1.2.1.15)

Defines the speed of change of the motor potentiometer value.

- 332 PID controller reference signal (Place A)** **57** (P1.1.11)

Defines which frequency reference place is selected for the PID controller.

Table 8-11: Selections for ID332

Application		
Select	5	7
0	AI1; terminals 2 – 3	AI1; terminals 2 – 3
1	AI2; terminals 4 – 5	AI2; terminals 4 – 5
2	PID ref. from menu M2, parameter R34	AI3
3	Fieldbus reference (FBProcessDataIN1)	AI4
4	Motor potentiometer reference	PID ref. from menu M2, parameter R34
5	—	Fieldbus reference (FBProcessDataIN1)
6	—	Motor potentiometer reference

Description of Parameters

- 333 PID controller actual value selection** **57** (P1.2.8, P1.2.1.8)
- This parameter selects the PID controller actual value.
- | | |
|----------|---|
| 0 | Actual value 1 |
| 1 | Actual value 1 + Actual value 2 |
| 2 | Actual value 1 – Actual value 2 |
| 3 | Actual value 1 * Actual value 2 |
| 4 | Greater one of Actual value 1 and Actual value 2 |
| 5 | Smaller one of Actual value 1 and Actual value 2 |
| 6 | Mean value of Actual value 1 and Actual value 2 |
| 7 | Square root of Actual value 1 + Square root of Actual value 2 |
- 334 Actual value 1 selection** **57** (P1.2.9, P1.2.1.9)
- 335 Actual value 2 selection** **57** (P1.2.10, P1.2.1.10)
- | | |
|----------|--|
| 0 | Not used |
| 1 | AI1 (control board) |
| 2 | AI2 (control board) |
| 3 | AI3 |
| 4 | AI4 |
| 5 | Fieldbus (<i>Actual value 1</i> : FBProcessDataIN2; <i>Actual value 2</i> : FBProcessDataIN3) |
- Application 5:**
- | | |
|-----------|---|
| 6 | Motor torque |
| 7 | Motor speed |
| 8 | Motor current |
| 9 | Motor power |
| 10 | Encoder frequency (for Actual value 1 only) |
- 336 Actual value 1 minimum scale** **57** (P1.2.11, P1.2.1.11)
- Sets the minimum scaling point for Actual value 1. See **Figure 8-22**.
- 337 Actual value 1 maximum scale** **57** (P1.2.12, P1.2.1.12)
- Sets the maximum scaling point for Actual value 1. See **Figure 8-22**.
- 338 Actual value 2 minimum scale** **57** (P1.2.13, P1.2.1.13)
- Sets the minimum scaling point for Actual value 2. See **Figure 8-22**.
- 339 Actual value 2 maximum scale** **57** (P1.2.14, P1.2.1.14)
- Sets the maximum scaling point for Actual value 2. See **Figure 8-22**.

Description of Parameters

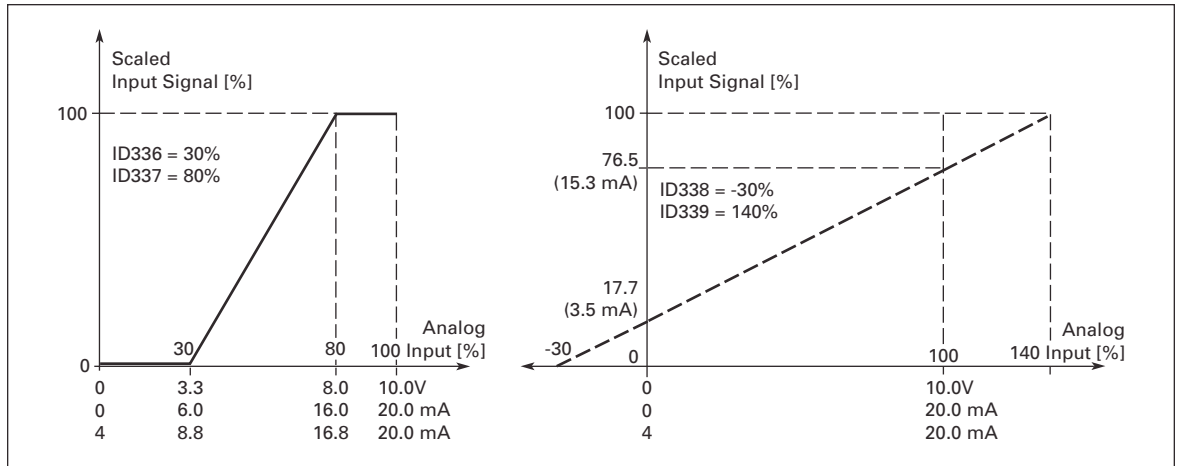

Figure 8-22: Examples of Actual Value Signal Scaling

340 PID error value inversion 57 (P1.2.32, P1.2.1.5)

This parameter allows you to invert the error value of the PID controller (and thus the operation of the PID controller).

- 0 No inversion
- 1 Inverted

341 PID reference rise time 57 (P1.2.33, P1.2.1.6)

Defines the time during which the PID controller reference rises from 0% to 100%.

342 PID reference fall time 57 (P1.2.34, P1.2.1.7)

Defines the time during which the PID controller reference falls from 100% to 0%.

344 Reference scaling minimum value, place B 57 (P1.2.35, P1.2.1.18)

Description of Parameters

345 Reference scaling maximum value, place B 57 (P1.2.36, P1.2.1.19)

You can choose a scaling range for the frequency reference from control place B between the Minimum and Maximum frequency.

If no scaling is desired set the parameter value to **0.0**.

In **Figure 8-23**, input AI1 with signal range 0 – 100% is selected for Place B reference.

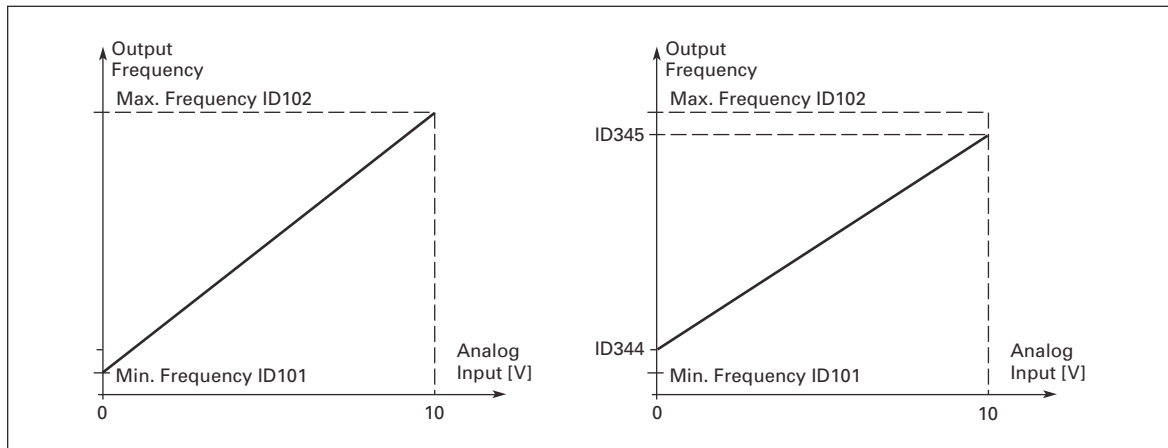

Figure 8-23: Control Place B with and without Reference Scaling
Left: ID344 = 0 (No reference scaling), Right: reference scaling

346 Output freq. limit 2 supervision function 34567 (P1.3.12, P1.3.4.3, P1.3.2.3)

- 0 No supervision
- 1 Low limit supervision
- 2 High limit supervision
- 3 Brake-on control (Application 6 only, see **Page A-1.**)
- 4 Brake-on/off control (Application 6 only, see **Page A-1.**)

If the output frequency goes under/over the set limit (ID347) this function generates a warning message via the digital output DO1 or relay outputs RO1 or RO2 depending on:

- 1) the settings of ID312 to ID314 (Applications 3, 4, 5) or ...
- 2) to which output the supervision signals (ID447 and ID448) are connected (Applications 6 and 7).

347 Output frequency limit 2 supervision value 34567 (P1.3.13, P1.3.4.4, P1.3.2.4)

Selects the frequency value supervised by ID346. See **Figure 8-16**.

Description of Parameters

348 Torque limit, supervision function 34567 (P1.3.14, P1.3.4.5, P1.3.2.5)

- 0 No supervision
- 1 Low limit supervision
- 2 High limit supervision
- 3 Brake-off control (Application 6 only, see **Page A-1.**)

If the calculated torque value falls below or exceeds the set limit (ID349) this function generates a warning message via the digital output DO1 or via a relay output RO1 or RO2 depending on:

- 1) the settings of ID312 to ID314 (Applications 3, 4, 5) or ...
- 2) to which output the supervision signal (ID451) is connected (Applications 6 and 7).

349 Torque limit, supervision value 34567 (P1.3.15, P1.3.4.6, P1.3.2.6)

Set here the torque value to be supervised by ID348.

Applications 3 and 4:

The torque supervision value can be reduced below the setpoint with the external free analog input signal, see ID361 and ID362.

350 Reference limit, supervision function 34567 (P1.3.16, P1.3.4.7, P1.3.2.7)

- 0 No supervision
- 1 Low limit supervision
- 2 High limit supervision

If the reference value falls below or exceeds the set limit (ID351), this function generates a warning message via the digital output DO1 or via a relay output RO1 or RO2 depending on:

- 1) the settings of ID312 to ID314 (Applications 3, 4, 5) or ...
- 2) to which output the supervision signal (ID451) is connected (Applications 6 and 7).

The supervised reference is the current active reference. It can be place A or B reference depending on DIN6 input, or panel reference if the panel is the active control place.

351 Reference limit, supervision value 34567 (P1.3.17, P1.3.4.8, P1.3.2.8)

The frequency value to be supervised by ID350.

Description of Parameters

- 352 External brake-off delay** **34567** (P1.3.18, P1.3.4.9, P1.3.2.9)
353 External brake-on delay **34567** (P1.3.19, P1.3.4.10, P1.3.2.10)

The function of the external brake can be timed to the start and stop control signals with these parameters. See **Figure 8-24** and **Page A-1**.

The brake control signal can be programmed via digital output DO1 or via one of the relay outputs RO1 and RO2, see ID312 to ID314 (Applications 3, 4, 5) or ID445 (Applications 6 and 7).

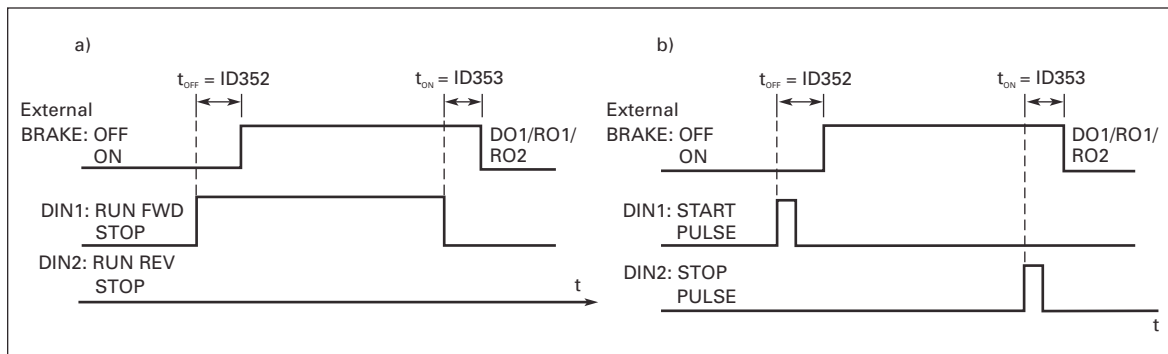

Figure 8-24: External Brake Control
a) Start/Stop Logic Selection, ID300 = 0, 1 or 2
b) Start/Stop Logic Selection, ID300 = 3

- 354 Frequency converter temperature limit supervision** **34567** (P1.3.20, P1.3.4.11, P1.3.2.11)
0 No supervision
1 Low limit supervision
2 High limit supervision

If the temperature of the frequency converter unit falls below or exceeds the set limit (ID355), this function generates a warning message via the digital output DO1 or via a relay output RO1 or RO2 depending on:

- 1) the settings of ID312 to ID314 (Applications 3, 4, 5) or ...
- 2) to which output the supervision signal (ID451) is connected (Applications 6 and 7).

- 355 Frequency converter temperature limit value** **34567** (P1.3.21, P1.3.4.12, P1.3.2.12)

This temperature value is supervised by ID354.

- 356 On/Off control signal** **6** (P1.3.4.13)

With this parameter, you can select the analog input to be monitored.

- 0** Not used
1 AI1
2 AI2
3 AI3
4 AI4

Description of Parameters

- 357 On/Off control low limit** **6** (P1.3.4.14)
- 358 On/Off control high limit** **6** (P1.3.4.15)

These parameters set the low and high limits of the signal selected with ID356. See **Figure 8-25**.

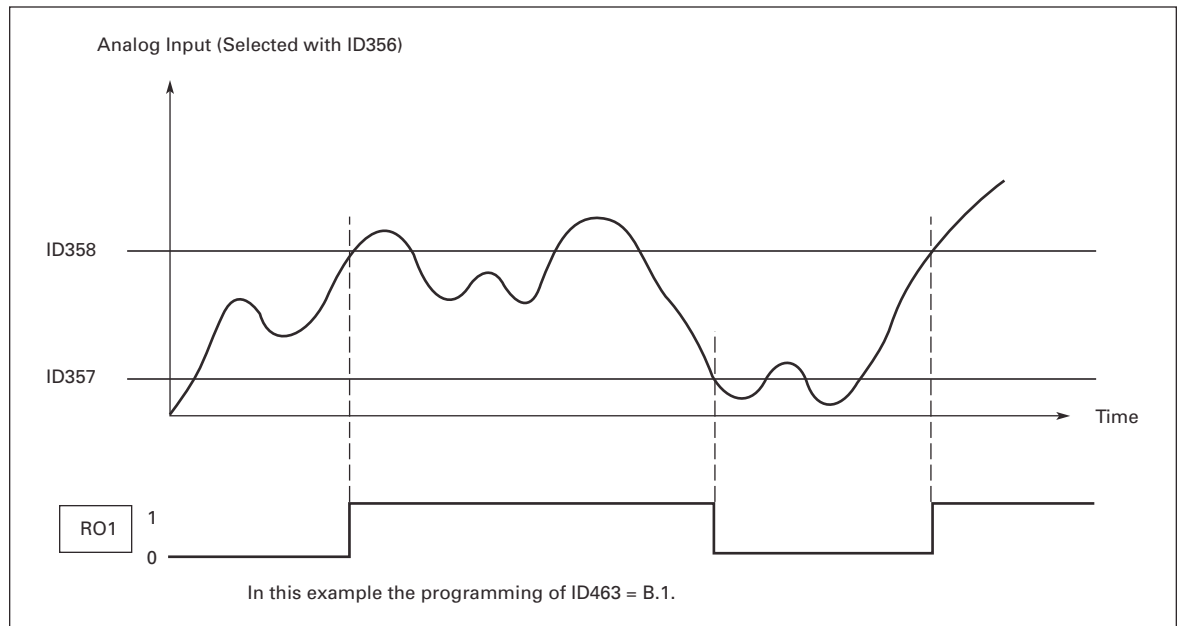

Figure 8-25: An Example of On/Off-Control

- 359 PID controller minimum limit** **5** (P1.2.30)
- 360 PID controller maximum limit** **5** (P1.2.31)

With these parameters, you can set the minimum and maximum limits for the PID controller output.

Limit setting: -1000.0% (of f_{max}) < ID359 < ID360 < 1000.0% (of f_{max}).

These limits are of importance for example when you define the gain, I-time and D-time for the PID controller.

- 361 Free analog input, signal selection** **34** (P1.2.20, P1.2.17)

Selection of input signal for the free analog input (an input not used for a reference signal):

- 0** Not in use
- 1** Voltage signal V_{in}
- 2** Current signal I_{in}

Description of Parameters

362 Free analog input, function 34 (P1.2.21, P1.2.18)

This parameter is used for selecting a function for the free analog input signal:

- 0 Function is not in use
- 1 Reduces motor current limit (ID107)

This signal will adjust the maximum motor current between 0 and maximum limit set with ID107. See **Figure 8-26**.

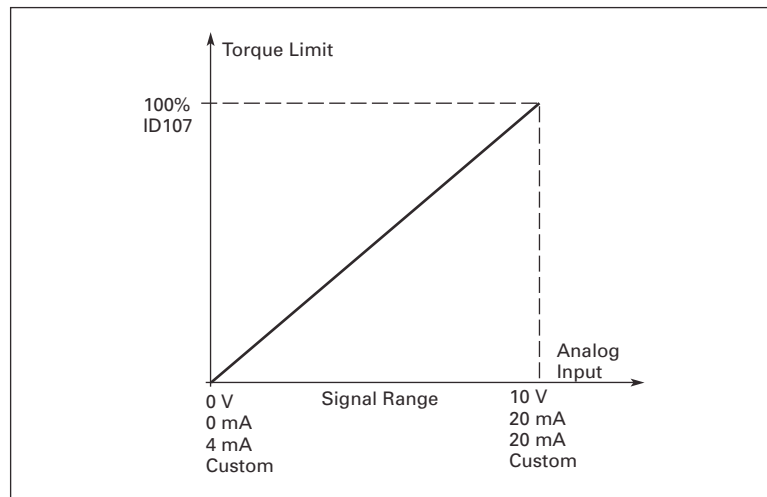

Figure 8-26: Scaling of Max. Motor Current

- 2 Reduces DC braking current
DC braking current can be reduced with the free analog input signal between current $0.4 \times I_H$ and the current set with ID507. See **Figure 8-27**.

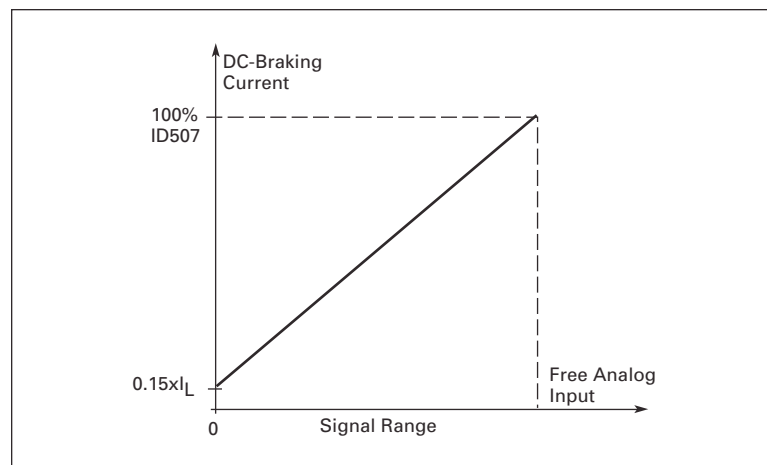

Figure 8-27: Reduction of DC Braking Current

Description of Parameters

- 3 Reduces acceleration and deceleration times
 Acceleration and deceleration times can be reduced with the free analog input signal according to the following formulas:
 Reduced time = set acc./decel. time (ID103, ID104; ID502, ID503) divided by the factor R in **Figure 8-28**.

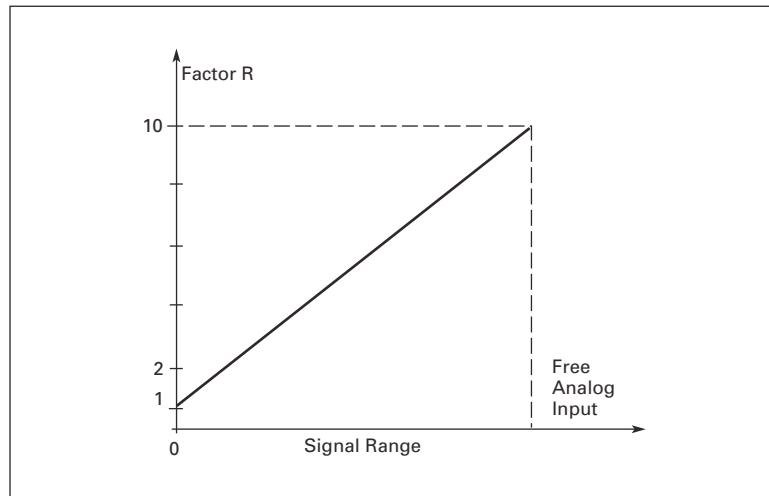

Figure 8-28: Reduction of Acceleration and Deceleration Times

- 4 Reduces torque supervision limit
 Set supervision limit can be reduced with the free analog input signal between 0 and set supervision limit (ID349), see **Figure 8-29**.

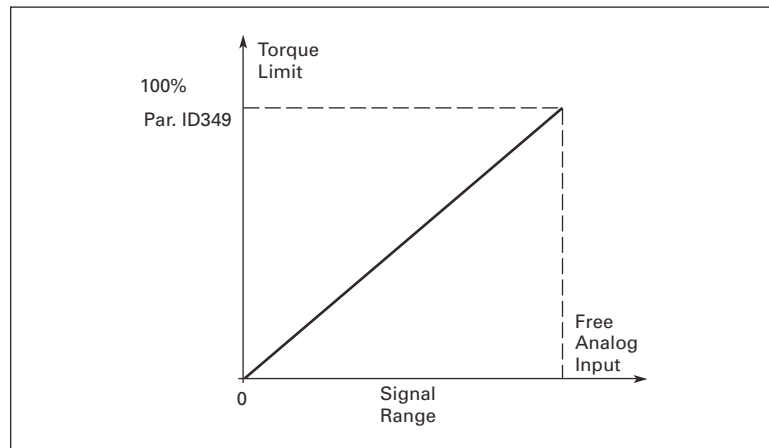

Figure 8-29: Reduction of Torque Supervision Limit

Description of Parameters

363 Start/Stop logic selection, place B **3** (P1.2.15)

0 DIN4: closed contact = start forward
 DIN5: closed contact = start reverse

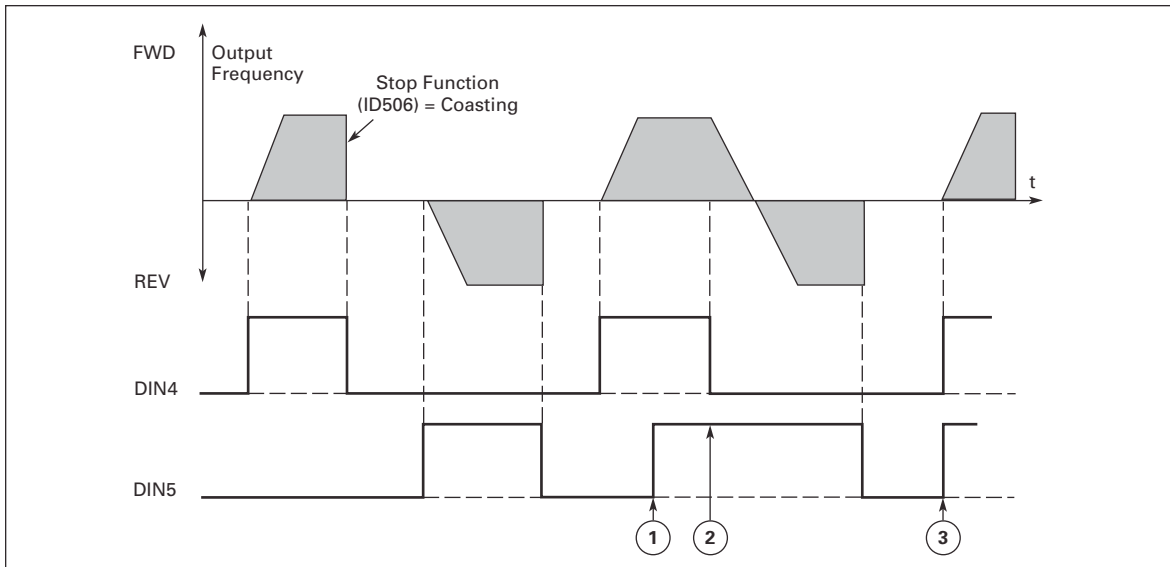

Figure 8-30: Place B Start Forward/Start Reverse

- ① The first selected direction has the highest priority.
 - ② When the DIN4 contact opens the direction of rotation starts to change.
 - ③ If Start forward (DIN4) and Start reverse (DIN5) signals are active simultaneously, the Start forward signal (DIN4) has priority.
- 1** DIN4: closed contact = start — open contact = stop
 DIN5: closed contact = reverse — open contact = forward
 See **Figure 8-31**.

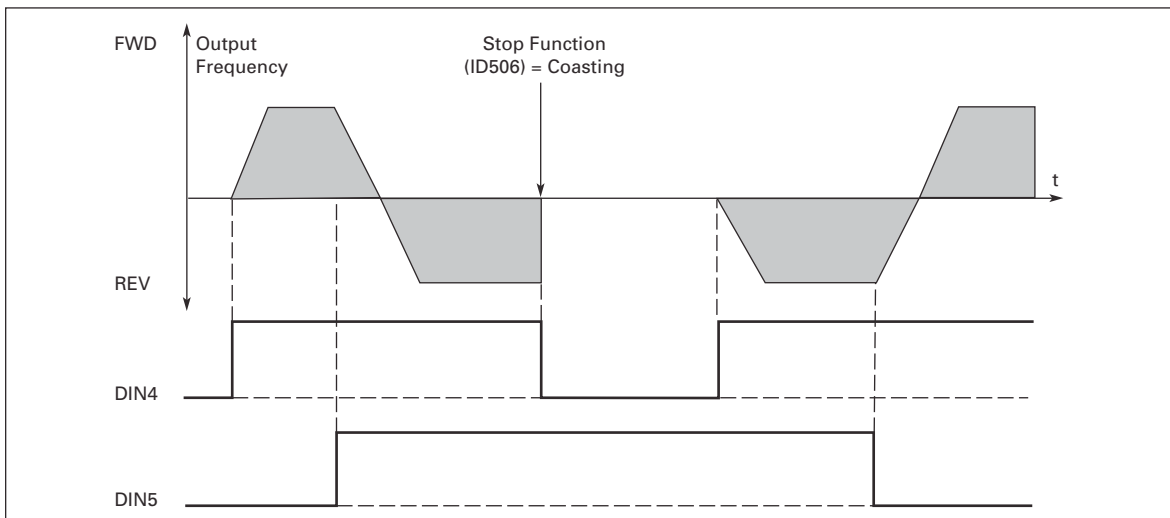

Figure 8-31: Place B Start, Stop, Reverse

Description of Parameters

- 2 DIN4: closed contact = start — open contact = stop
 DIN5: closed contact = start enabled —
 open contact = start disabled and drive stopped if running
- 3 3-wire connection (pulse control):
 DIN4: closed contact = start pulse
 DIN5: open contact = stop pulse
 (DIN3 can be programmed for reverse command) See **Figure 8-32**.

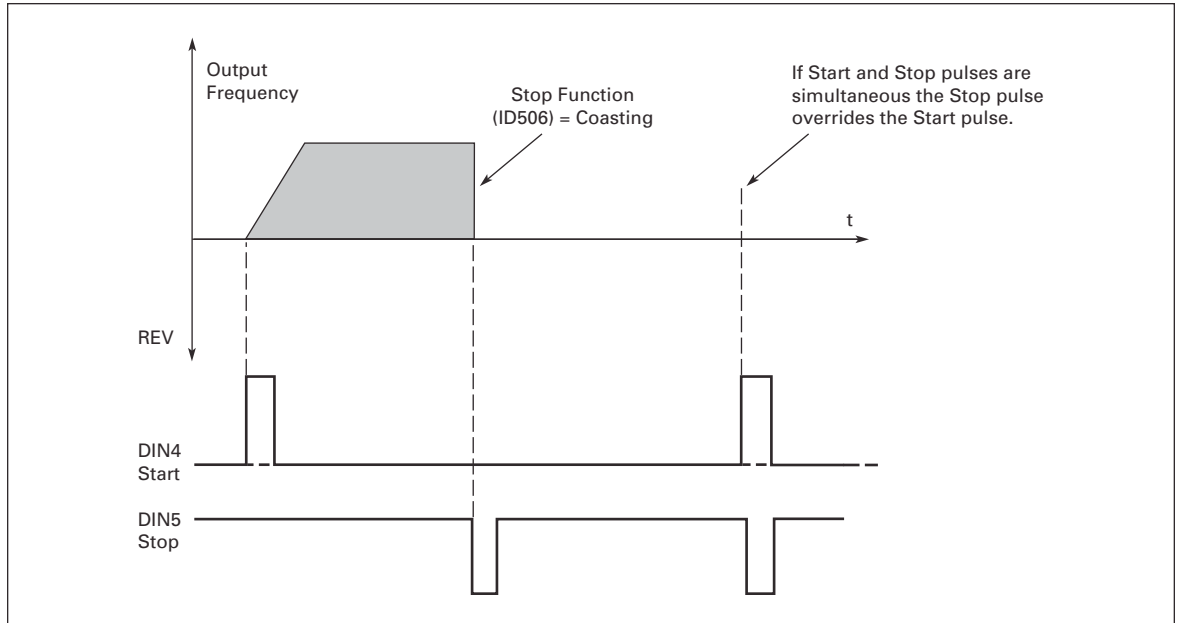

Figure 8-32: Place B Start Pulse/Stop Pulse

Selections **4** to **6** are used to exclude the possibility of an unintentional start when, for example, power is connected, re-connected after a power failure, after a fault reset, after the drive is stopped by Run Enable (Run Enable = False) or when the control place is changed. The Start/Stop contact must be opened before the motor can be started.

- 4 DIN4: closed contact = start forward (**Rising edge required to start**)
 DIN5: closed contact = start reverse (**Rising edge required to start**)
- 5 DIN4: closed contact = start (**Rising edge required to start**) —
 open contact = stop
 DIN5: closed contact = reverse — open contact = forward
- 6 DIN4: closed contact = start (**Rising edge required to start**) —
 open contact = stop
 DIN5: closed contact = start enabled —
 open contact = start disabled and drive stopped if running

364 Reference scaling, minimum value, place B 3 (P1.2.18)

365 Reference scaling, maximum value, place B 3 (P1.2.19)

See ID303 and ID304 above.

Description of Parameters

367 Motor potentiometer memory reset (Frequency reference) **3567** (P1.2.23, P1.2.28, P1.2.1.3, P1.2.1.16)

- 0** No reset
- 1** Memory reset in stop and power down
- 2** Memory reset in power down

370 Motor potentiometer memory reset (PID reference) **57** (P1.2.29, P1.2.1.17)

- 0** No reset
- 1** Memory reset in stop and power down
- 2** Memory reset in power down

371 PID reference 2 (Place A additional reference) **7** (P1.2.1.4)

If the *PID reference 2 enable* input function ID330 = TRUE, this parameter defines which reference place is selected as PID controller reference.

- 0** AI1 reference (terminals 2 and 3, e.g. potentiometer)
- 1** AI2 reference (terminals 5 and 6, e.g. transducer)
- 2** AI3 reference
- 3** AI4 reference
- 4** PID reference 1 from keypad
- 5** Reference from Fieldbus (FBProcessDataIN3)
- 6** Motor potentiometer
- 7** PID reference 2 from keypad

If value **6** is selected for this parameter, the functions *Motor potentiometer DOWN* and *Motor potentiometer UP* must be connected to digital inputs (ID417 and ID418).

372 Supervised analog input **7** (P1.3.2.13)

- 0** Analog reference from AI1 (terminals 2 and 3, e.g. potentiometer)
- 1** Analog reference from AI2 (terminals 4 and 5, e.g. transducer)

373 Analog input limit supervision **7** (P1.3.2.14)

If the value of the selected analog input goes under/over the set limit (ID374), this function generates a warning message through the digital output or the relay outputs depending on to which output the supervision function (ID463) is connected.

- 0** No supervision
- 1** Low limit supervision
- 2** High limit supervision

August 2010

Description of Parameters

374 Analog input supervised value 7 (P1.3.2.15)

The value of the selected analog input to be supervised by ID373.

375 Analog output offset 67 (P1.3.5.7, P1.3.3.7)

Add -100.0 to 100.0% to the analog output.

376 PID sum point reference (Place A direct reference) 5 (P1.2.4)

Defines which reference source is added to PID controller output if PID controller is used.

- 0** No additional reference (Direct PID output value)
- 1** PID output + AI1 reference from terminals 2 and 3 (e.g. potentiometer)
- 2** PID output + AI2 reference from terminals 4 and 5 (e.g. transducer)
- 3** PID output + PID keypad reference
- 4** PID output + Fieldbus reference (FBSpeedReference)
- 5** PID output + Motor potentiometer reference

If value **5** is selected for this parameter, the values of ID319 and ID301 are automatically set to 13. See **Figure 8-33**.

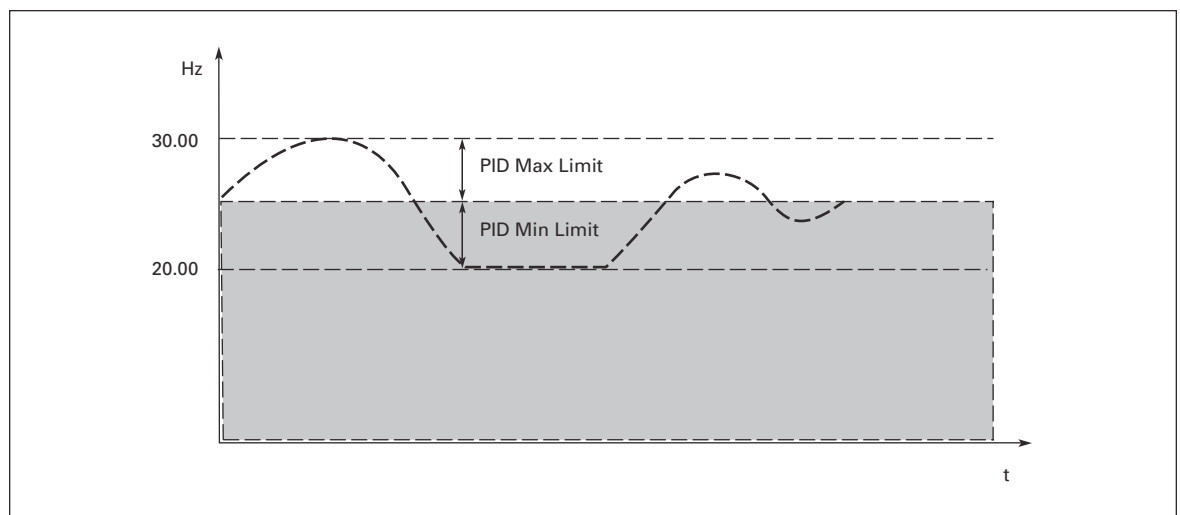

Figure 8-33: PID Sum Point Reference

Note: The maximum and minimum limits illustrated in the picture limit only the PID output, no other outputs are affected.

Description of Parameters

377 [®] **AI1 signal selection** **234567** (P1.2.8, P1.2.3, P1.2.15, P1.2.2.1)

Connect the AI1 signal to the analog input of your choice with this parameter. For more information about the TTF programming method, see **Page 6-3**.

384 **AI1 joystick hysteresis** **6** (P1.2.2.8)

This parameter defines the joystick hysteresis between 0 and 20%. When the joystick or potentiometer control is turned from reverse to forward, the output frequency falls linearly to the selected minimum frequency (joystick/potentiometer in middle position) and stays there until the joystick/potentiometer is turned towards the forward command. How much the joystick/potentiometer must be turned to start the increase of the frequency towards the selected maximum frequency, is dependent on the amount of joystick hysteresis defined with this parameter.

If the value of this parameter is 0, the frequency starts to increase linearly immediately when the joystick/potentiometer is turned towards the forward command from the middle position. When the control is changed from forward to reverse, the frequency follows the same pattern the other way round. See **Figure 8-34**.

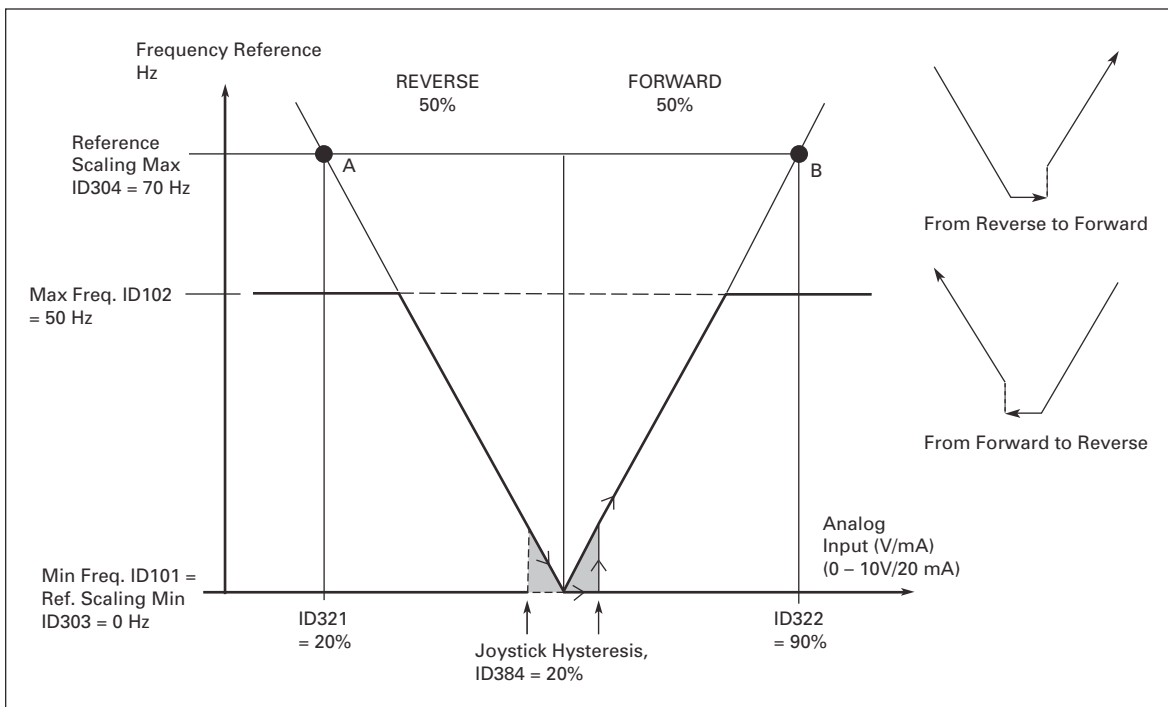

Figure 8-34: An Example of Joystick Hysteresis
In this example, the value of ID385 (Sleep limit) = 0

Description of Parameters

385 AI1 sleep limit 6 (P1.2.2.9)

The frequency converter is automatically stopped if the AI signal level falls below the Sleep limit defined with this parameter. See **Figure 8-35**.

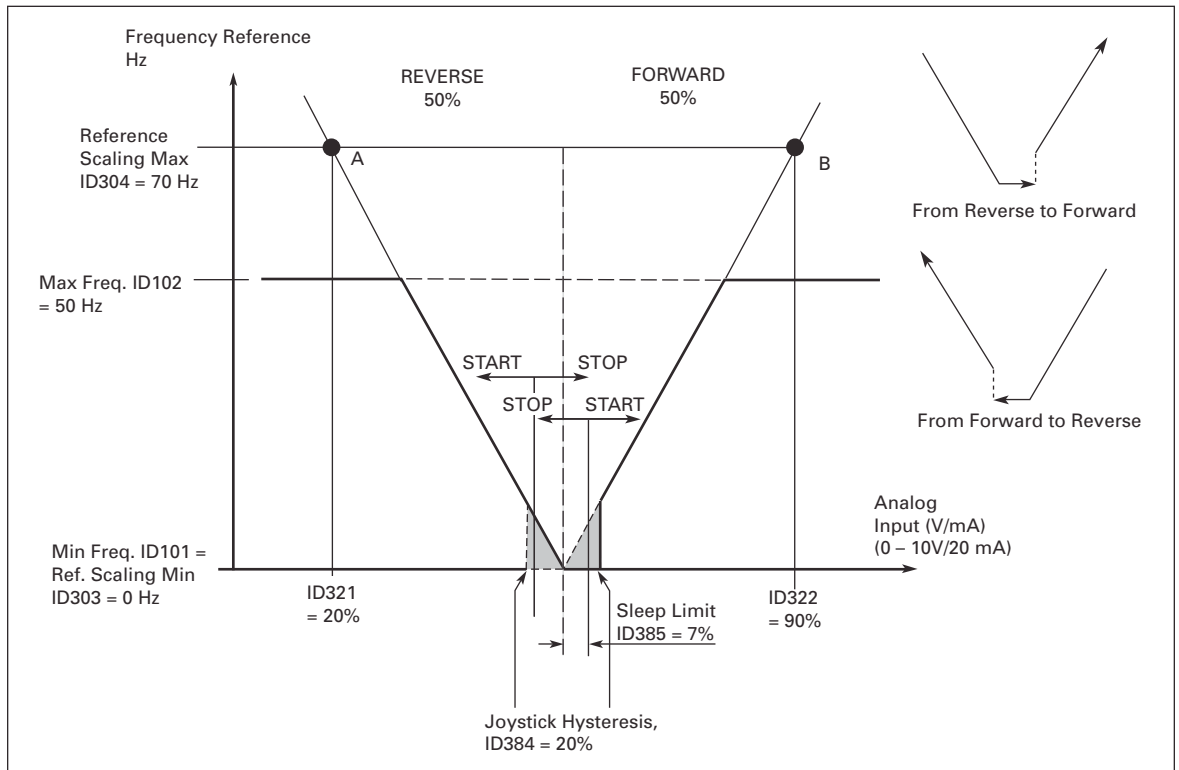

Figure 8-35: Example of Sleep Limit Function

Description of Parameters

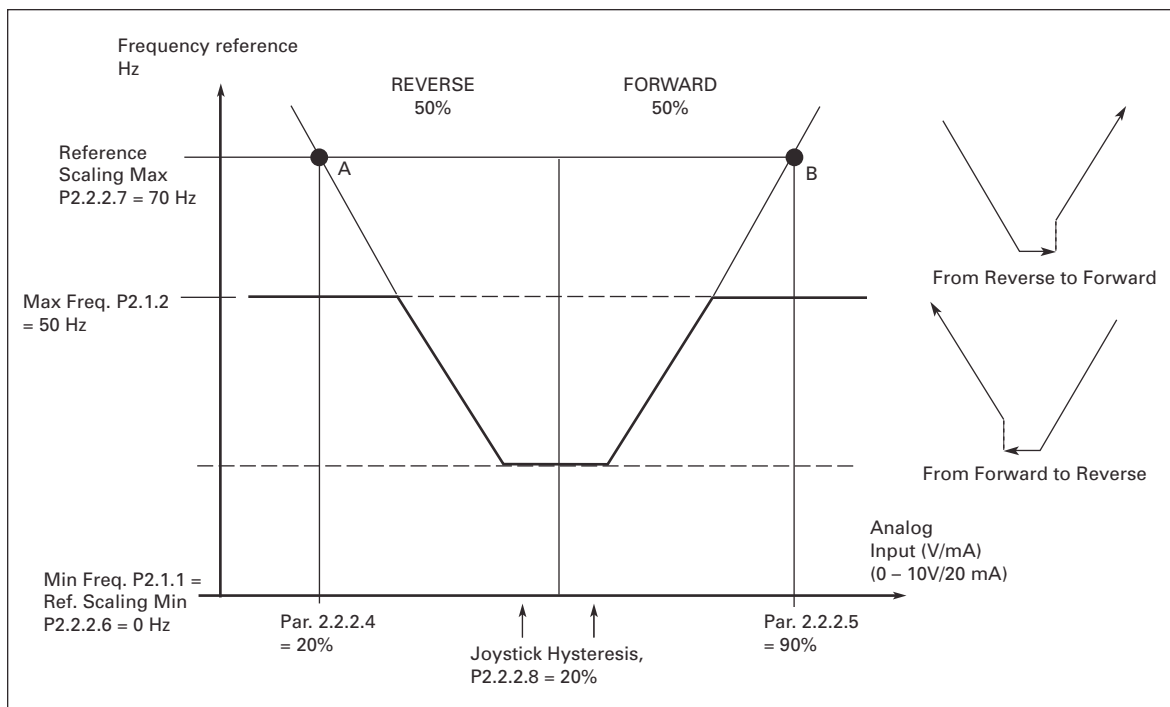

Figure 8-36: Joystick Hysteresis with Minimum Frequency at 35 Hz

386 AI1 sleep delay 6 (P1.2.2.10)

This parameter defines the time the analog input signal has to stay under the Sleep limit determined with parameter ID385 in order to stop the frequency converter.

388[®] AI2 signal selection 234567 (P1.2.9, P1.2.21, P1.2.3.1)

Connect the AI2 signal to the analog input of your choice with this parameter. For more information about the TTF programming method, see **Page 6-3**.

Description of Parameters

393	AI2 reference scaling, minimum value	6	(P1.2.3.6)
394	AI2 reference scaling, maximum value See ID303 and ID304.	6	(P1.2.3.7)
395	AI2 joystick hysteresis See ID384.	6	(P1.2.3.8)
396	AI2 sleep limit See ID385.	6	(P1.2.3.9)
397	AI2 sleep delay See ID386.	6	(P1.2.3.10)
399	Scaling of current limit	6	(P1.2.6.1)
	0 Not used		
	1 AI1		
	2 AI2		
	3 AI3		
	4 AI4		
	5 Fieldbus (FBProcessDataIN2)		

This signal will adjust the maximum motor current between 0 and max. limit set with ID107.

400	Scaling of DC-braking current	6	(P1.2.6.2)
------------	--------------------------------------	----------	-------------------

See ID399 for the selections.

DC-braking current can be reduced with the free analog input signal between current $0.4 \times I_H$ and the current set with ID507. See **Figure 8-37**.

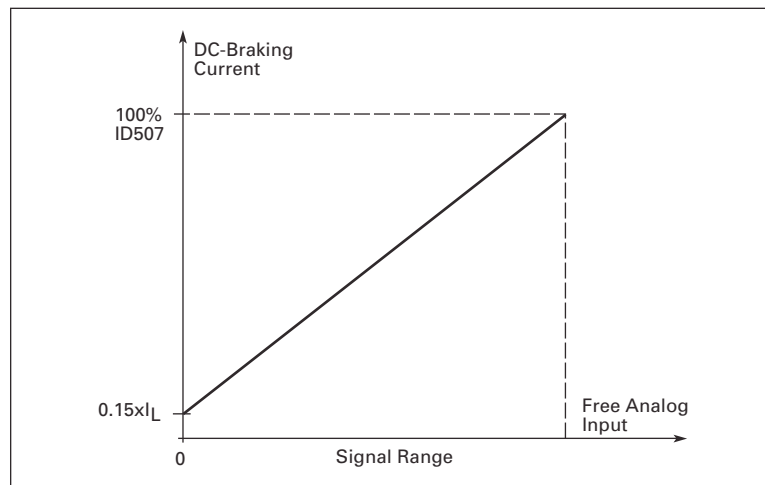

Figure 8-37: Scaling of DC-Braking Current

Description of Parameters

401 Reducing of acceleration and deceleration times 6 (P1.2.6.3)

See ID399.

Acceleration and deceleration times can be reduced with the free analog input signal according to the following formulas:

Reduced time = set acc./deceler. time (ID103, ID104; ID502, ID503) divided by the factor R from **Figure 8-38**.

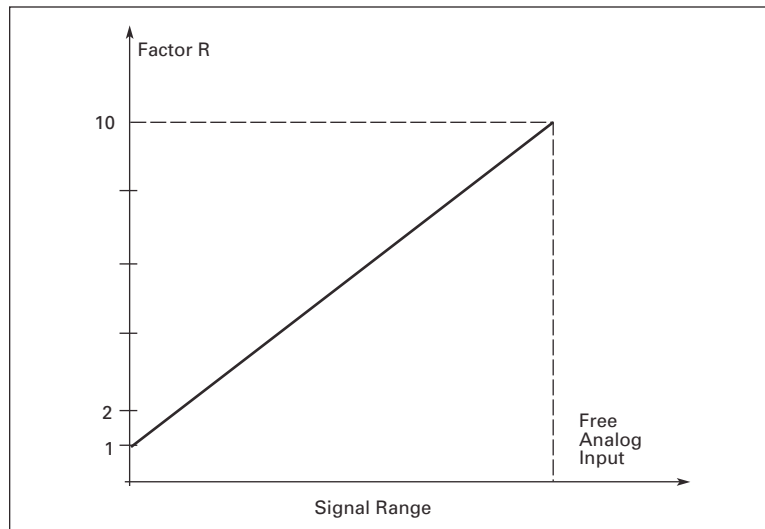

Figure 8-38: Reducing Acceleration and Deceleration Times

402 Reducing of torque supervision limit 6 (P1.2.6.4)

See ID399.

The set torque supervision limit can be reduced with the free analog input signal between 0 and the set supervision limit, ID349. See **Figure 8-39**.

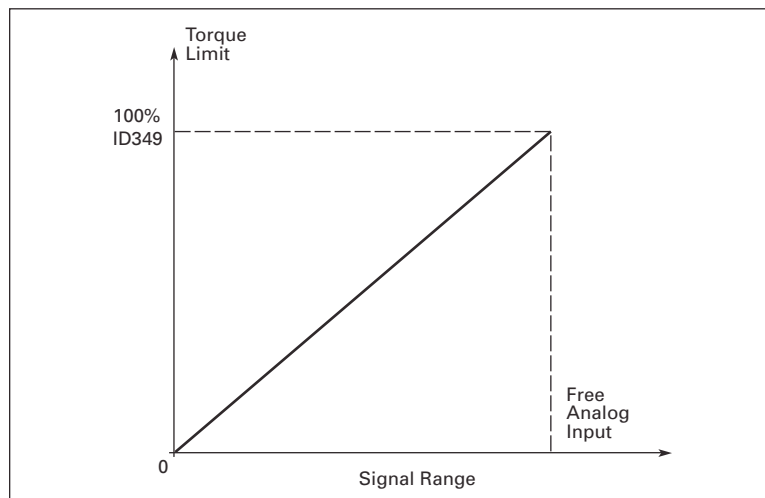

Figure 8-39: Reducing Torque Supervision Limit

August 2010

Description of Parameters

403 ®	Start signal 1	6	(P1.2.7.1)
	Signal selection 1 for the start/stop logic. Default programming A.1.		
404 ®	Start signal 2	6	(P1.2.7.2)
	Signal selection 2 for the start/stop logic. Default programming A.2.		
405 ®	External fault (close)	67	(P1.2.7.11, P1.2.6.4)
	Contact closed: Fault is displayed and motor stopped		
406 ®	External fault (open)	67	(P1.2.7.12, P1.2.6.5)
	Contact open: Fault is displayed and motor stopped		
407 ®	Run enable	67	(P1.2.7.3, P1.2.6.6)
	Contact open: Start of motor disabled Contact closed: Start of motor enabled		
408 ®	Acceleration/Deceleration time selection	67	(P1.2.7.13, P1.2.6.7)
	Contact open: Acceleration/Deceleration time 1 selected Contact closed: Acceleration/Deceleration time 2 selected Set Acceleration/Deceleration times with ID103 and ID104.		
409 ®	Control from I/O terminal	67	(P1.2.7.18, P1.2.6.8)
	Contact closed: Force control place to I/O terminal		
410 ®	Control from keypad	67	(P1.2.7.19, P1.2.6.9)
	Contact closed: Force control place to keypad		
412 ®	Reverse	67	(P1.2.7.4, P1.2.6.11)
	Contact open: Direction forward Contact closed: Direction reverse		
413 ®	Jogging speed	67	(P1.2.7.10, P1.2.6.13)
	Contact closed: Jog speed selected for frequency reference See parameter ID124. Default programming: A.4.		

Description of Parameters

414 ®	Fault reset	67	(P1.2.7.10, P1.2.6.13)
	Contact closed: All faults are reset.		
415 ®	Acceleration/Deceleration prohibited	67	(P1.2.7.14, P1.2.6.14)
	Contact closed: No acceleration or deceleration possible until the contact is opened.		
416 ®	DC-braking	67	(P1.2.7.15, P1.2.6.15)
	Contact closed: In STOP mode, the DC braking operates until the contact is opened.		
417 ®	Motor potentiometer DOWN	67	(P1.2.7.8, P1.2.6.16)
	Contact closed: Motor potentiometer reference DECREASES until the contact is opened.		
418 ®	Motor potentiometer UP	67	(P1.2.7.9, P1.2.6.17)
	Contact closed: Motor potentiometer reference INCREASES until the contact is opened.		
419 ®	Preset speed 1	6	(P1.2.7.5)
420 ®	Preset speed 2	6	(P1.2.7.6)
421 ®	Preset speed 3	6	(P1.2.7.7)
	Parameter values are automatically limited between the minimum and maximum frequencies (ID101 and ID102).		
422 ®	AI1/AI2 selection	6	(P1.2.7.17)
	This parameter is used to select either AI1 or AI2 signal as the frequency reference.		
423 ®	Start A signal	7	(P1.2.6.1)
	Start command from control place A. Default programming: A.1		
424 ®	Start B signal	7	(P1.2.6.2)
	Start command from control place B. Default programming: A.4		
425 ®	Control place A/B selection	7	(P1.2.6.3)
	Contact open: Control place A Contact closed: Control place B Default programming: A.6		

Description of Parameters

426 ®	Autochange 1 interlock	7	(P1.2.6.18)
	Contact closed: Interlock of autochange drive 1 or auxiliary drive 1 activated. Default programming: A.2.		
427 ®	Autochange 2 interlock	7	(P1.2.6.19)
	Contact closed: Interlock of autochange drive 2 or auxiliary drive 2 activated. Default programming: A.3.		
428 ®	Autochange 3 interlock	7	(P1.2.6.20)
	Contact closed: Interlock of autochange drive 3 or auxiliary drive 3 activated.		
429 ®	Autochange 4 interlock	7	(P1.2.6.21)
	Contact closed: Interlock of autochange drive 4 or auxiliary drive 4 activated.		
430 ®	Autochange 5 interlock	7	(P1.2.6.22)
	Contact closed: Interlock of autochange drive 5 activated.		
431 ®	PID reference 2	7	(P1.2.6.23)
	Contact open: PID controller reference selected with ID332. Contact closed: PID controller keypad reference 2 selected with ID371.		
432 ®	Ready	67	(P1.3.3.1, P1.3.1.1)
	The frequency converter is ready to operate.		
433 ®	Run	67	(P1.3.3.2, P1.3.1.2)
	The frequency converter is operating (the motor is running).		
434 ®	Fault	67	(P1.3.3.3, P1.3.1.3)
	A fault trip has occurred. Default programming: A.1 for Application 7 and B.2 for Application 6.		
435 ®	Inverted fault	67	(P1.3.3.4, P1.3.1.4)
	No fault trip has occurred.		
436 ®	Warning	67	(P1.3.3.5, P1.3.1.5)
	General warning signal.		

Description of Parameters

437 [Ⓢ]	External fault or warning	67	(P1.3.3.6, P1.3.1.6)
	Fault or warning depending on ID701.		
438 [Ⓢ]	Reference fault or warning	67	(P1.3.3.7, P1.3.1.7)
	Fault or warning depending on ID700.		
439 [Ⓢ]	Overtemperature warning	67	(P1.3.3.8, P1.3.1.8)
	The heatsink temperature exceeds +70°C.		
440 [Ⓢ]	Reverse	67	(P1.3.3.9, P1.3.1.9)
	The Reverse command has been selected.		
441 [Ⓢ]	Unrequested direction	67	(P1.3.3.10, P1.3.1.10)
	Motor rotation direction is different from the requested one.		
442 [Ⓢ]	At speed	67	(P1.3.3.11, P1.3.1.11)
	The output frequency has reached the set reference.		
443 [Ⓢ]	Jogging speed	67	(P1.3.3.12, P1.3.1.12)
	Jogging speed selected.		
444 [Ⓢ]	External control place	67	(P1.3.3.13, P1.3.1.13)
	Control from I/O terminal selected (Menu M2 ; ID125).		
445 [Ⓢ]	External brake control	67	(P1.3.3.14, P1.3.1.14)
	External brake ON/OFF control with programmable delay.		
446 [Ⓢ]	External brake control, inverted	67	(P1.3.3.15, P1.3.1.15)
	External brake ON/OFF control; Output active when brake control is OFF.		
447 [Ⓢ]	Output frequency limit 1 supervision	67	(P1.3.3.16, P1.3.1.16)
	The output frequency is outside the set supervision low limit/high limit (see ID315 and ID316).		
448 [Ⓢ]	Output frequency limit 2 supervision	67	(P1.3.3.17, P1.3.1.17)
	The output frequency is outside the set supervision low limit/high limit (see ID346 and ID347).		

Description of Parameters

- 449** [Ⓢ] **Reference limit supervision** **67** (P1.3.3.18, P1.3.1.18)
Active reference is beyond the set supervision low limit/high limit (see ID350 and ID351).
- 450** [Ⓢ] **Temperature limit supervision** **67** (P1.3.3.19, P1.3.1.19)
The frequency converter heatsink temperature is beyond the set supervision limits (see ID354 and ID355).
- 451** [Ⓢ] **Torque limit supervision** **67** (P1.3.3.20, P1.3.1.20)
The motor torque is beyond the set supervision limits (see ID348 and ID349).
- 452** [Ⓢ] **Motor thermal protection** **67** (P1.3.3.21, P1.3.1.21)
Motor thermistor initiates an overtemperature signal which can be tied to a digital output.
Note: This parameter will not work unless you have an OPTA3 or OPTB2 (thermistor relay board) connected.
- 454** [Ⓢ] **Motor regulator activation** **67** (P1.3.3.23, P1.3.1.23)
Overvoltage or overcurrent regulator has been activated.
- 455** [Ⓢ] **Fieldbus input data 1** **67** (P1.3.3.24, P1.3.1.24)
(FBFixedControlWord, bit 3)
- 456** [Ⓢ] **Fieldbus input data 2** **67** (P1.3.3.25, P1.3.1.25)
(FBFixedControlWord, bit 4)
- 457** [Ⓢ] **Fieldbus input data 3** **67** (P1.3.3.26, P1.3.1.26)
(FBFixedControlWord, bit 5)
The data from the fieldbus (FBFixedControlWord) can be tied to frequency converter digital outputs.
- 458** [Ⓢ] **Autochange 1/Auxiliary drive 1 control** **7** (P1.3.1.27)
Control signal for autochange/auxiliary drive 1.
Default programming: B.1
- 459** [Ⓢ] **Autochange 2/Auxiliary drive 2 control** **7** (P1.3.1.28)
Control signal for autochange/auxiliary drive 2.
Default programming: B.2
- 460** [Ⓢ] **Autochange 3/Auxiliary drive 3 control** **7** (P1.3.1.29)
Control signal for autochange/auxiliary drive 3. If three (or more) auxiliary drives are used, we recommend the use of a relay output to connect drive 3. Since the OPTA2 board only has two relay outputs, it is advisable to purchase an I/O expander board with extra relay outputs (e.g. OPTB5).

Description of Parameters

- 461** [Ⓢ] **Autochange 4/Auxiliary drive 4 control** **7** (P1.3.1.30)
Control signal for autochange/auxiliary drive 4. If three (or more) auxiliary drives are used, we recommend the use of relay outputs, to connect drives 3 and 4. Since the OPTA2 board only has two relay outputs it is advisable to purchase an I/O expander board with extra relay outputs (e.g. OPTB5).
- 462** [Ⓢ] **Autochange 5 control** **7** (P1.3.1.31)
Control signal for autochange drive 5.
- 463** [Ⓢ] **Analog input supervision limit** **67** (P1.3.3.22, P1.3.1.22)
The selected analog input signal is beyond the set supervision limits (see ID372, ID373 and ID374).
- 464** [Ⓢ] **Analog output 1 signal selection** **234567** (P1.3.1, P1.3.5.1, P1.3.3.1)
Connect the AO1 signal to the analog output of your choice with this parameter. For more information about the TTF programming method, see **Page 6-3**.
- 471** [Ⓢ] **Analog output 2 signal selection** **234567** (P1.3.12, P1.3.22, P1.3.6.1, P1.3.4.1)
Connect the AO2 signal to the analog output of your choice with this parameter. For more information about the TTF programming method, see **Page 6-3**.
- 472** **Analog output 2 function** **234567** (P1.3.13, P1.3.23, P1.3.6.2, P1.3.4.2)
473 **Analog output 2 filter time** **234567** (P1.3.14, P1.3.24, P1.3.6.3, P1.3.4.3)
474 **Analog output 2 inversion** **234567** (P1.3.15, P1.3.25, P1.3.6.4, P1.3.4.4)
475 **Analog output 2 minimum** **234567** (P1.3.16, P1.3.26, P1.3.6.5, P1.3.4.5)
476 **Analog output 2 scaling** **234567** (P1.3.17, P1.3.27, P1.3.6.6, P1.3.4.6)
For more information on these five parameters, see the corresponding parameters for the analog output 1, ID307 to ID311.
- 477** **Analog output 2 offset** **67** (P1.3.6.7, P1.3.4.7)
Add -100.0 to 100.0% to the analog output.
- 478** [Ⓢ] **Analog output 3, signal selection** **67** (P1.3.7.1, P1.3.5.1)
See ID464.
- 479** **Analog output 3, function** **67** (P1.3.7.2, P1.3.5.2)
See ID307.
- 480** **Analog output 3, filter time** **67** (P1.3.7.3, P1.3.5.3)
See ID308.

Description of Parameters

481	Analog output 3 inversion	67	(P1.3.7.4, P1.3.5.4)
	See ID309.		
482	Analog output 3 minimum	67	(P1.3.7.5, P1.3.5.5)
	See ID310.		
483	Analog output 3 scaling	67	(P1.3.7.6, P1.3.5.6)
	See ID311.		
484	Analog output 3 offset	67	(P1.3.7.7, P1.3.5.7)
	See ID375.		
485	Torque limit	6	(P1.2.6.5)
	See ID399 for the selections.		
486 ®	Digital output 1 signal selection 6	6	(P1.3.1.1)
	Connect the delayed DO1 signal to the digital output of your choice with this parameter. For more information about the TTF programming method, see Page 6-3 .		
487	Digital output 1 on-delay	6	(P1.3.1.3)
488	Digital output 1 off-delay	6	(P1.3.1.4)

With these parameters you can set on- and off-delays for digital outputs.

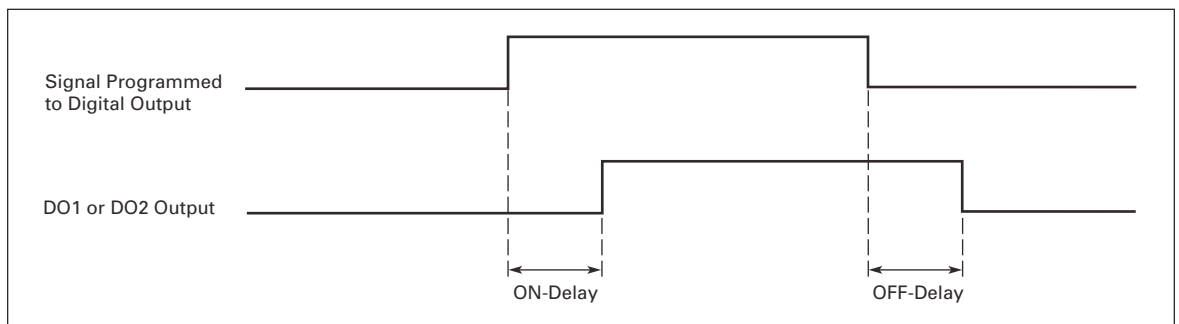

Figure 8-40: Digital Outputs 1 and 2, On- and Off-Delays

489 ®	Digital output 2 signal selection 6	6	(P1.3.2.1)
	See ID486.		
490	Digital output 2 function	6	(P1.3.2.2)
	See ID312.		
491	Digital output 2 on-delay	6	(P1.3.2.3)
	See ID487.		

Description of Parameters

492 Digital output 2 off-delay **6** (P1.3.1.4)
See ID488.

493 Adjust input **6** (P1.2.1.4)

With this parameter you can select the signal, according to which the frequency reference to the motor is fine adjusted.

- 0** Not used
- 1** Analog input 1
- 2** Analog input 2
- 3** Analog input 3
- 4** Analog input 4
- 5** Signal from fieldbus (FBProcessDataIN)

494 Adjust minimum **6** (P1.2.1.5)

495 Adjust maximum **6** (P1.2.1.6)

These parameters define the minimum and maximum of adjusted signals. See **Figure 8-41**.

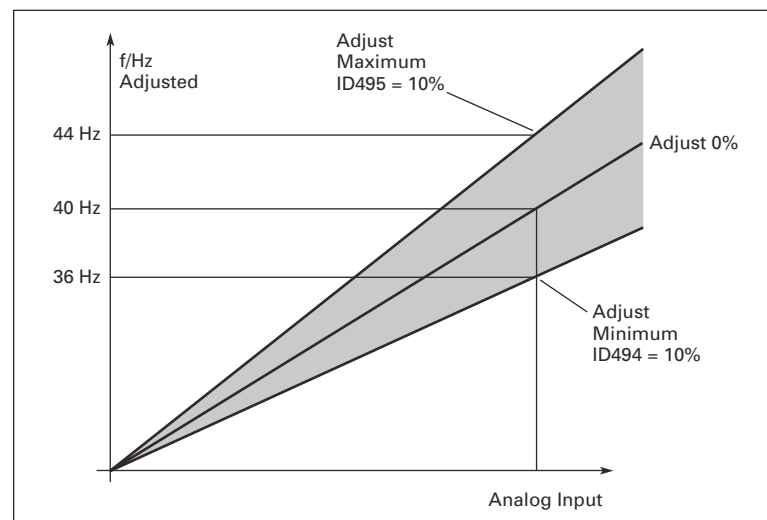

Figure 8-41: An Example of Adjust Input

496 [Ⓢ] **Parameter Set 1/Set 2 selection** **6** (P1.2.7.21)

With this parameter you can select between Parameter Set 1 and Set 2. The input for this function can be selected from any slot. The procedure of selecting between the sets is explained in the *9000X AF Drives User Manual, Chapter 5*.

Digital input = FALSE:

- The active set is saved to set 2
- Set 1 is loaded as the active set

Digital input = TRUE:

- The active set is saved to set 1
- Set 2 is loaded as the active set

Note: The parameter values can be changed in the active set only.

Description of Parameters

- 504 Brake chopper** **234567** (P1.4.5)
- 0** No brake chopper used
- 1** Brake chopper in use and tested when running. Can be tested also in READY state
- 2** External brake chopper (no testing)
- 3** Used and tested in READY state and when running
- 4** Used when running (no testing)
- When the frequency converter is decelerating the motor, the inertia of the motor and the load is fed into an external brake resistor. This enables the frequency converter to decelerate the load with a torque equal to that of acceleration (provided that the correct brake resistor has been selected). See the separate Brake resistor installation manual.
- 505 Start Function** (P1.4.6)
- Ramp:
- 0** The frequency converter starts from 0 Hz and accelerates to the set reference frequency within the set acceleration time. (Load inertia or starting friction may cause prolonged acceleration times.)
- Flying start:
- 1** The frequency converter is able to start into a running motor by applying a small torque to motor and searching for the frequency corresponding to the speed the motor is running at. Searching starts from the maximum frequency towards the actual frequency until the correct value is detected. Thereafter, the output frequency will be increased/decreased to the set reference value according to the set acceleration/deceleration parameters.
- Use this mode if the motor is coasting when the start command is given, with the flying start it is possible to ride through short utility voltage interruptions.
- 506 Stop Function** (P1.4.7)
- Coasting:
- 0** The motor coasts to a halt without any control from the frequency converter, after the Stop command.
- Ramp:
- 1** After the Stop command, the speed of the motor is decelerated according to the set deceleration parameters. If the regenerated energy is high it may be necessary to use an external braking resistor for faster deceleration.
- Normal stop: Ramp/ Run Enable stop: coasting
- 2** After the Stop command, the speed of the motor is decelerated according to the set deceleration parameters. However, when Run Enable is selected, the motor coasts to a halt without any control from the frequency converter.
- Normal stop: Coasting/ Run Enable stop: ramping
- 3** The motor coasts to a halt without any control from the frequency converter. However, when Run Enable signal is selected, the speed of the motor is decelerated according to the set deceleration parameters. If the regenerated energy is high, it may be necessary to use an external braking resistor for faster deceleration.

Description of Parameters

507 DC-braking current 234567 (P1.4.8)

Defines the current injected into the motor during DC-braking.

508 DC-braking time at stop 234567 (P1.4.9)

Determines if braking is ON or OFF and the braking time of the DC-brake when the motor is stopping. The function of the DC-brake depends on the stop function, ID506.

0.0 DC-brake is not used

>0.0 DC-brake is in use and its function depends on the Stop function, (ID506). The DC-braking time is determined with this parameter.

Par. ID506 = 0; Stop function = Coasting:

After the stop command, the motor coasts to a stop without control of the frequency converter.

With DC-injection, the motor can be electrically stopped in the shortest possible time, without using an optional external braking resistor.

The braking time is scaled according to the frequency when the DC-braking starts. If the frequency is \geq the nominal frequency of the motor, the set value of parameter ID508 determines the braking time. When the frequency is $\leq 10\%$ of the nominal, the braking time is 10% of the set value of ID508.

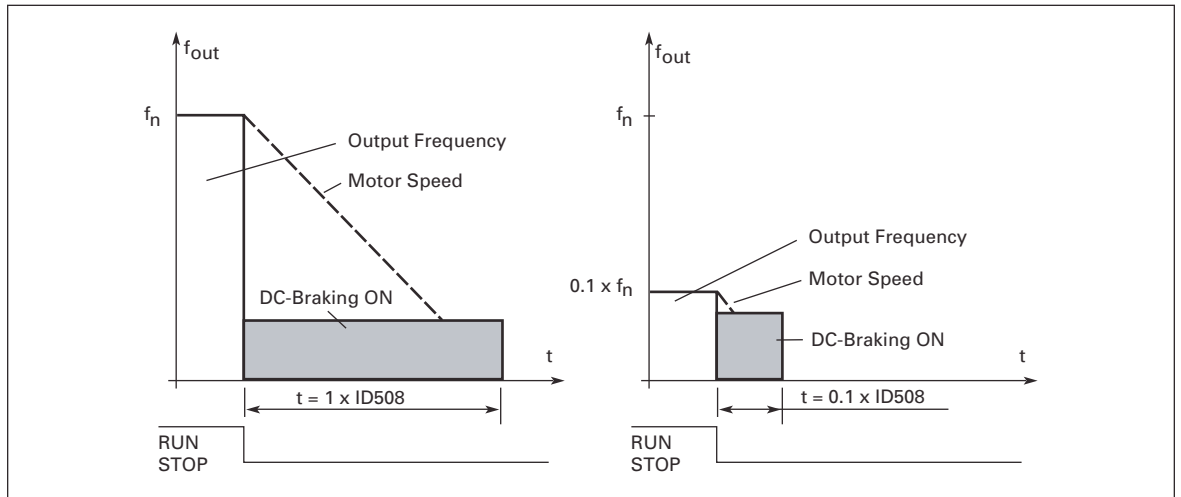

Figure 8-43: DC-Braking Time when Stop Mode = Coasting

Description of Parameters

Par. ID506 = 1; Stop function = Ramp:

After the Stop command, the speed of the motor is reduced according to the set deceleration parameters, as fast as possible, to the speed defined with ID515, where the DC-braking starts.

The braking time is defined with ID508. If high inertia exists, it is recommended to use an external braking resistor for faster deceleration. See **Figure 8-44**.

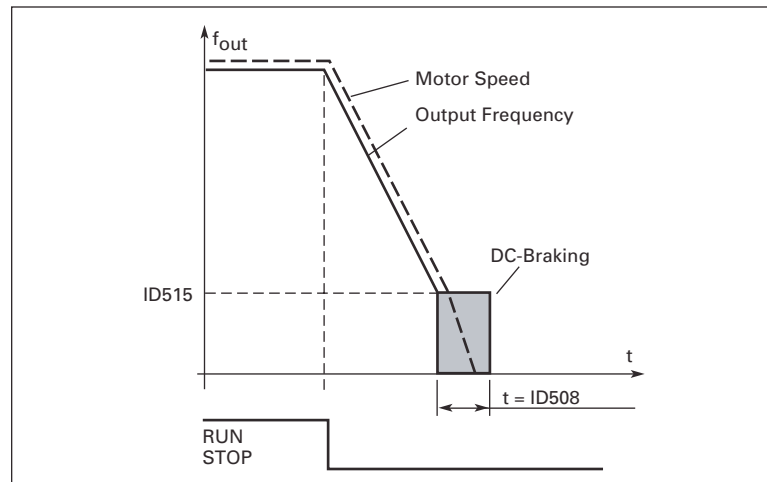

Figure 8-44: DC-Braking Time when Stop Mode = Ramp

Description of Parameters

509	Skip frequency area 1; Low limit	234567	(P1.5.1)
510	Skip frequency area 1; High limit	234567	(P1.5.2)
511	Skip frequency area 2; Low limit	34567	(P1.5.3)
512	Skip frequency area 2; High limit	34567	(P1.5.4)
513	Skip frequency area 3; Low limit	34567	(P1.5.5)
514	Skip frequency area 3; High limit	34567	(P1.5.6)

In some systems it may be necessary to avoid certain frequencies because of mechanical resonance problems. With these parameters limits are set for the “skip frequency” regions. See **Figure 8-45**.

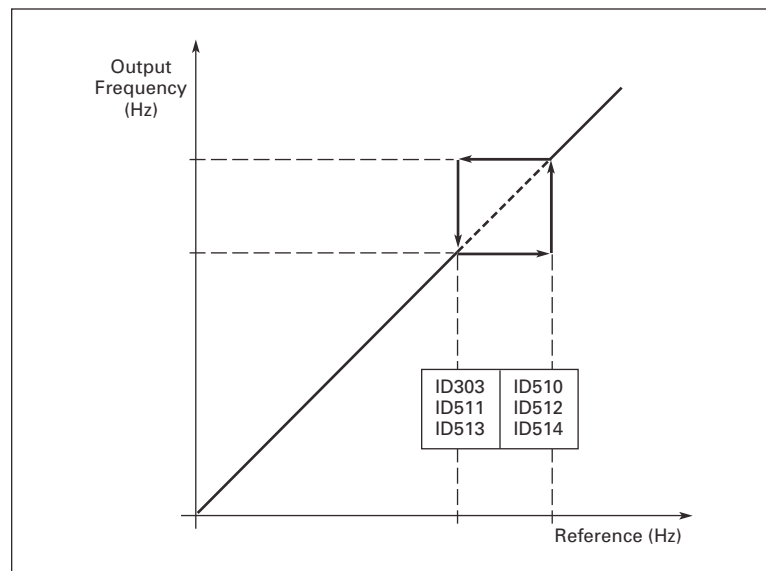

Figure 8-45: Example of Skip Frequency Area Setting

515	DC-braking frequency at stop	234567	(P1.4.10)
------------	-------------------------------------	---------------	-----------

The output frequency at which the DC-braking is applied. See **Figure 8-45**.

516	DC-braking time at start	234567	(P1.4.11)
------------	---------------------------------	---------------	-----------

DC-brake is activated when the start command is given. This parameter defines the time before the brake is released. After the brake is released, the output frequency increases according to the set start function by ID505.

Description of Parameters

518 Acceleration/deceleration ramp speed scaling ratio between skip frequency limits (P1.5.3, P1.5.7)

Defines the acceleration/deceleration time when the output frequency is between the selected skip frequency range limits (ID509 and ID510). The ramping speed (selected acceleration/deceleration time 1 or 2) is multiplied with this factor. E.g. value 0.1 makes the acceleration time 10 times shorter than outside the skip frequency range limits.

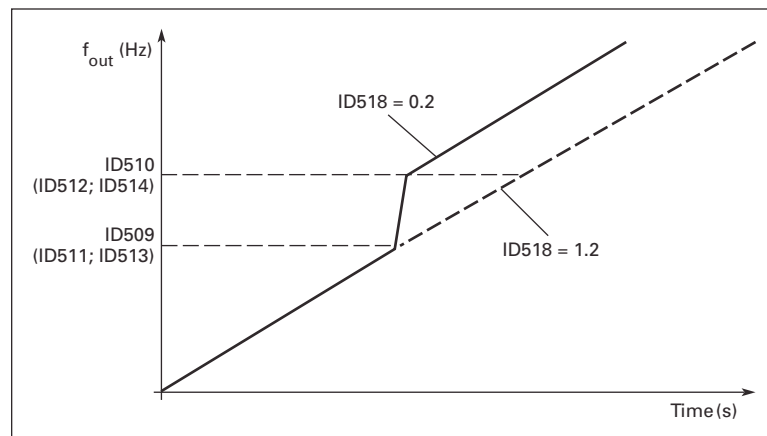

Figure 8-46: Ramp Speed Scaling between Skip Frequencies

519 Flux braking current 234567 (P1.4.13)

Defines the flux braking current value. This value can be set between $0.4 \cdot I_H$ and the Current limit.

520 Flux brake 234567 (P1.4.12)

Instead of DC braking, flux braking is a useful form of braking for motors ≤ 15 kW. When braking is needed, the frequency is reduced and the flux in the motor is increased, which in turn increases the motor's capability to brake. Unlike DC braking, the motor speed remains controlled during braking.

The flux braking can be set ON or OFF.

0 Flux braking OFF

1 Flux braking ON

Note: Flux braking converts the energy into heat in the motor, and should be used intermittently to avoid motor damage.

Description of Parameters

- 521 Motor control mode 2 6 (P1.6.12)**
- With this parameter you can set another motor control mode. The mode which is used is determined by ID164.
For the available selections, see ID600.
- 600 Motor control mode 234567 (P1.6.1)**
- SVX:**
- 0** Frequency control: The I/O terminal and keypad references are frequency references and the frequency converter controls the output frequency (output frequency resolution = 0.01 Hz)
- 1** Speed control: The I/O terminal and keypad references are speed references and the frequency converter controls the motor speed compensating for motor slip (accuracy $\pm 0.5\%$).
- SPX:**
- The following selections are available for SPX drives only, except for selection **2**, which is available in the Multi-Purpose Control Application for SVX drives also.
- 2** Torque control: In torque control mode, the references are used to control the motor torque.
- 3** Speed control (closed loop): The I/O terminal and keypad references are speed references and the frequency converter controls the motor speed very accurately comparing the actual speed received from the tachometer to the speed reference (accuracy $\pm 0.01\%$).
- 4** Torque control (closed loop): The I/O terminal and keypad references are torque references and the frequency converter controls the motor torque.
- 601 Switching frequency 234567 (P1.6.9)**
- Motor noise can be minimized using a high switching frequency. Increasing the switching frequency reduces the capacity of the frequency converter unit. The range of this parameter depends on the size of the frequency converter:

Table 8-12: Size-Dependent Switching Frequencies

Voltage	Drive Rating HP (I _L)	Min. (kHz)	Max. (kHz)	Default (kHz)
230 (208 – 240) V:	1 – 20 HP	1.0	16.0	10.0
230 (208 – 240) V:	25 – 30 HP	1.0	10.0	3.6
480 (380 – 500) V:	1-1/2 – 40 HP	1.0	16.0	10.0
480 (380 – 500) V:	50 – 250 HP	1.0	6.0	3.6
575 (525 – 690) V:	All	1.0	6.0	1.5

- 602 Field weakening point 234567 (P1.6.4)**
- The field weakening point is the output frequency at which the output voltage reaches the set (ID603) maximum value.

Description of Parameters

- 603 Voltage at field weakening point** **234567** (P1.6.5)
- Above the frequency at the field weakening point, the output voltage remains at the set maximum value. Below the frequency at the field weakening point, the output voltage depends on the setting of the V/Hz curve parameters. See ID109, ID108, ID604 and ID605.
- When the parameters ID110 and ID111 (nominal voltage and nominal frequency of the motor) are set, the parameters ID602 and ID603 are automatically set to the corresponding values. If you need different values for the field weakening point and the maximum output voltage, change these parameters **after** setting ID110 and ID111.
- 604 V/Hz curve, middle point frequency** **234567** (P1.6.6)
- If the programmable V/Hz curve has been selected with ID108 this parameter defines the middle point frequency of the curve. See **Figure 8-2**.
- 605 V/Hz curve, middle point voltage** **234567** (P1.6.7)
- If the programmable V/Hz curve has been selected with the ID108 this parameter defines the middle point voltage of the curve. See **Figure 8-2**.
- 606 Output voltage at zero frequency** **234567** (P1.6.8)
- If the programmable V/Hz curve has been selected with the ID108 this parameter defines the zero frequency voltage of the curve. See **Figure 8-2**.
- 607 Overvoltage controller** **234567** (P1.6.10)
- These parameters allow the under-/overvoltage controllers to be switched out of operation. This may be useful, for example, if the main supply voltage varies more than -15% to +10% and the application will not tolerate this over-/undervoltage. In this case, the regulator controls the output frequency taking the supply fluctuations into account.
- | | |
|----------|--|
| 0 | Controller switched off |
| 1 | Controller switched on (no ramping) = Minor adjustments of OP frequency are made |
| 2 | Controller switched on (with ramping) = Controller adjusts OP freq. up to max. freq. |
- 608 Undervoltage controller** **234567** (P1.6.11)
- See ID607.
- Note:** Over-/undervoltage trips may occur when the controllers are switched off.
- | | |
|----------|-------------------------|
| 0 | Controller switched off |
| 1 | Controller switched on |
- 609 Torque limit** **6** (P1.10.1)
- With this parameter you can set the torque limit control between 0.0 – 400.0%.

Description of Parameters

- 610 Torque limit control P-gain** **6** (P1.10.2)
This parameter defines the gain of the torque limit controller.
- 611 Torque limit control I-gain** **6** (P1.10.3)
This parameter determines the I-gain of the torque limit controller.
- 612 CL: Magnetizing current** **234567** (P1.6.12.1, P1.6.15.1)
Sets the motor magnetizing current (no-load current). See **Page A-3**.
- 613 CL: Speed control P-gain** **234567** (P1.6.12.2, P1.6.15.2)
Sets the gain for the speed controller in % per Hz. See **Page A-3**.
- 614 CL: Speed control I-time** **234567** (P1.6.12.3, P1.6.15.3)
Sets the integral time constant for the speed controller. Increasing the I-time increases stability but lengthens the speed response time. See **Page A-3**.
- 615 CL: Zero speed time at start** **234567** (P1.6.12.9, P1.6.15.9)
After giving the start command the drive will remain at zero speed for the time defined by this parameter. The ramp will be released to follow the set frequency/speed reference after this time has elapsed from the instant where the command is given. See **Page A-3**.
- 616 CL: Zero speed time at stop** **234567** (P1.6.12.10, P1.6.15.10)
The drive will remain at zero speed with controllers active for the time defined by this parameter after reaching the zero speed when a stop command is given. This parameter has no effect if the selected stop function (ID506) is Coasting. See **Page A-3**.
- 617 CL: Current control P-gain** **234567** (P1.6.12.17, P1.6.15.17)
Sets the gain for the current controller. This controller is active only in closed loop and advanced open loop modes. The controller generates the voltage vector reference to the modulator. See **Page A-3**.
- 618 CL: Encoder filter time** **234567** (P1.6.12.18, P1.6.15.18)
Sets the filter time constant for speed measurement.
The parameter can be used to eliminate encoder signal noise. Too high a filter time reduces speed control stability. See **Page A-3**.
- 619 CL: Slip adjust** **234567** P1.6.12.6, P1.6.15.6)
The motor name plate speed is used to calculate the nominal slip. This value is used to adjust the voltage of motor when loaded. The name plate speed is sometimes a little inaccurate and this parameter can therefore be used to trim the slip. Reducing the slip adjust value increases the motor voltage when the motor is loaded. See **Page A-3**.

Description of Parameters

- 620 CL: Load drooping 234567 (P1.6.12.4, P1.6.15.4)**
The drooping function enables speed drop as a function of load. This parameter sets that amount corresponding to the nominal torque of the motor. See **Page A-3**.
- 621 CL: Startup torque 234567 (P1.6.12.11, P1.6.15.11)**
Chooses the startup torque.
Torque Memory is used in crane applications. Startup torque FWD/REV can be used in other applications to help the speed controller. See **Page A-3**.
- | | |
|----------|--------------|
| 0 | Not Used |
| 1 | TorqMemory |
| 2 | torque Ref |
| 3 | Torq.Fwd/Rev |
- 626 CL: Acceleration compensation 234567 (P1.6.12.5, P1.6.15.5)**
Sets the inertia compensation to improve speed response during acceleration and deceleration. The time is defined as acceleration time to nominal speed with nominal torque. This parameter is also active in advanced open loop mode.
- 627 CL: Magnetizing current at start 234567 (P1.6.12.7, P1.6.15.7)**
- 628 CL: Magnetizing time at start 234567 (P1.6.12.8, P1.6.15.8)**
Sets the rise time of magnetizing current.
- 631 Identification 23456 (P1.6.13, P1.6.16)**
With this parameter, the drive will identify the motor and adjust tuning parameters to improve starting torque and closed loop current control. See Chapter 6 of the 9000X User Manual.
- | | |
|----------|--|
| 0 | No Action |
| 1 | OL V/F Ratio-ID No Run; the drive is run at zero speed to identify the stator motor parameters. |
| 2 | OL V/F + Boost; same as ID No Run and then turns on V/Hz Boost. |
| 3 | (MultiPurpose APP, SPX Only) ID With Run; performs an ID No Run, and then runs the motor at 2/3 rated frequency to identify the motor no load current and motor saturation curve. Motor must be unloaded for an accurate ID Run. |
- 633 CL: Start-up torque, forward 234567 (P1.6.13.5, P1.6.16.5)**
Sets the start-up torque for forward direction if selected with parameter P1.6.12.11.
- 634 CL: Start-up torque, reverse 234567 (P1.6.13.2, P1.6.16.2)**
Sets the start-up torque for reverse direction if selected with parameter P1.6.12.11.

August 2010

Description of Parameters

- 636 Minimum frequency for Open Loop torque control** **6** (P1.10.8)
- Defines the frequency limit below which the frequency converter operates in the frequency control mode.
- Because of the nominal slip of the motor, the internal torque calculation is inaccurate at low speeds where it is recommended to use the frequency control mode.
- 637 Speed controller P gain, Open Loop** **6** (P1.6.13)
- Defines the P gain for the speed controlled in Open Loop control mode.
- 638 Speed controller I gain, Open Loop** **6** (P1.6.14)
- Defines the I gain for the speed controlled in Open Loop control mode.
- 639 Torque controller P gain** **6** (P1.10.9)
- Defines the P gain of the torque controller.
- 640 Torque controller I gain** **6** (P1.10.10)
- Defines the I gain of the torque controller.
- 641 Torque reference selection** **6** (P1.10.4)
- Defines the source for torque reference.
- | | |
|----------|-----------------------------|
| 0 | Not used |
| 1 | Analog input 1 |
| 2 | Analog input 2 |
| 3 | Analog input 3 |
| 4 | Analog input 4 |
| 5 | Analog input 1 (joystick) |
| 6 | Analog input 2 (joystick) |
| 7 | From keypad, parameter R3.5 |
| 8 | Fieldbus |
- 642 Torque reference scaling, maximum value** **6** (P1.10.5)
- 643 Torque reference scaling, minimum value** **6** (P1.10.6)
- Scale the custom minimum and maximum levels for analog inputs within -300.0 – 300.0%.

Description of Parameters

644 Torque speed limit 6 (P1.10.7)

With this parameter the maximum frequency for the torque control can be selected.

- 0 Maximum frequency, ID102
- 1 Selected frequency reference
- 2 Preset speed 7, ID130

700 Response to the reference fault 234567 (P1.7.1)

- 0 No response
- 1 Warning
- 2 Warning, the frequency from 10 seconds back is set as reference
- 3 Warning, the Preset Frequency (ID728) is set as reference
- 4 Fault, stop mode after fault according to ID506
- 5 Fault, stop mode after fault always by coasting

A warning or a fault action and message is generated if the 4 – 20 mA reference signal is used and the signal falls below 3.5 mA for 5 seconds or below 0.5 mA for 0.5 seconds. The information can also be programmed into digital output DO1 or relay outputs RO1 and RO2.

701 Response to external fault 234567 (P1.7.3)

- 0 No response
- 1 Warning
- 2 Fault, stop mode after fault according to ID506
- 3 Fault, stop mode after fault always by coasting

A warning or a fault action and message is generated from the external fault signal in the programmable digital inputs DIN3. The information can also be programmed into digital output DO1 and into relay outputs RO1 and RO2.

702 Output phase supervision 234567 (P1.7.6)

- 0 No response
- 1 Warning
- 2 Fault, stop mode after fault according to ID506
- 3 Fault, stop mode after fault always by coasting

Output phase supervision of the motor ensures that the motor phases have approximately equal currents.

703 Earth fault protection 234567 (P1.7.7)

- 0 No response
- 1 Warning
- 2 Fault, stop mode after fault according to ID506
- 3 Fault, stop mode after fault always by coasting

Earth fault protection ensures that the sum of the motor phase currents is zero. The overcurrent protection is always working and protects the frequency converter from earth faults with high currents.

Description of Parameters

704 Motor thermal protection 234567 (P1.7.8)

- 0 No response
- 1 Warning
- 2 Fault, stop mode after fault according to ID506
- 3 Fault, stop mode after fault always by coasting

If tripping is selected the drive will stop and activate the fault stage. Deactivating this protection, i.e. setting parameter to **0**, will reset the thermal stage of the motor to 0%. See **Page A-4**.

**705 Motor thermal protection: 234567 (P1.7.9)
Motor ambient temp. factor**

The factor can be set between -100.0% – 100.0%. See **Page A-4**.

**706 Motor thermal protection: 234567 (P1.7.10)
Motor cooling factor at zero speed**

The current can be set between 0 – 150.0% × I_{nMotor} . This parameter sets the value for thermal current at zero frequency. See **Figure 8-47**.

The default value is set assuming that there is no external fan cooling the motor. If an external fan is used this parameter can be set to 90% (or even higher).

Note: The value is set as a percentage of the motor nameplate data, ID113 (nominal current of the motor), not the drive’s nominal output current. The motor’s nominal current is the current that the motor can withstand in direct on-line use without being overheated.

If you change the parameter Nominal current of motor, this parameter is automatically restored to the default value.

Setting this parameter does not affect the maximum output current of the drive which is determined by ID107 alone. See **Page A-4**.

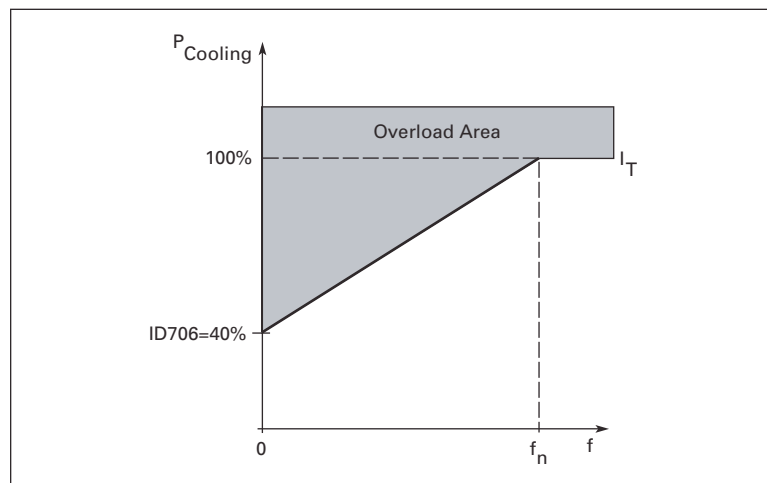

Figure 8-47: Motor Thermal Current I_T Curve

Description of Parameters

707 Motor thermal protection: 234567 (P1.7.11) Time constant

This time can be set between 1 and 200 minutes.

This is the thermal time constant of the motor, the larger the motor, the longer the time constant. The time constant is the time within which the calculated thermal stage has reached 63% of its final value.

The motor thermal time is specific to the motor design and it varies between different motor manufacturers.

If the motor's t_6 – time (t_6 is the time in seconds the motor can safely operate at six times the rated current) is known (given by the motor manufacturer) the time constant parameter can be set based on it. As a rule of thumb, the motor thermal time constant in minutes is equal to $2 \times t_6$. If the drive is in stop stage the time constant is internally increased to three times the set parameter value. The cooling in the stop stage is based on convection and the time constant is increased. See **Figure 8-48**.

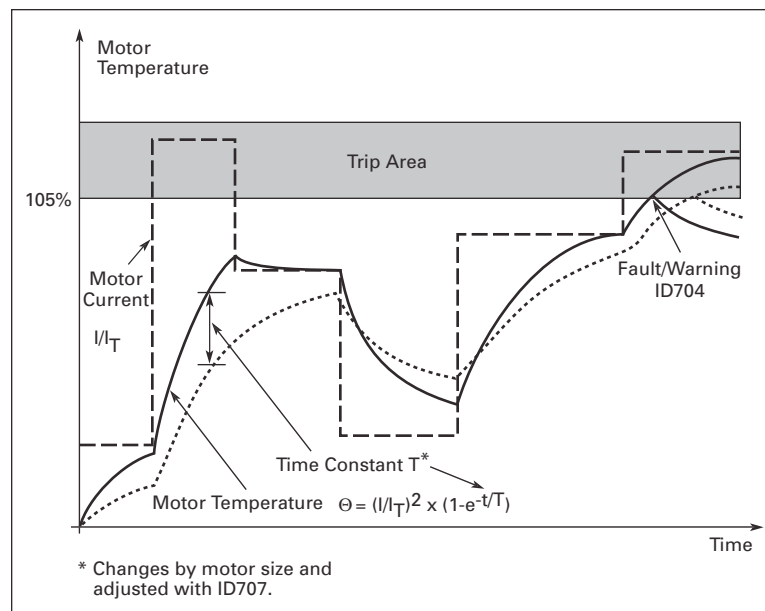

Figure 8-48: Motor Temperature Calculation

708 Motor thermal protection: 234567 (P1.7.12) Motor duty cycle

Defines how much of the nominal motor load is applied. The value can be set to 0% – 100%. See **Page A-4**.

709 Stall protection 234567 (P1.7.13)

- 0 No response
- 1 Warning
- 2 Fault, stop mode after fault according to ID506
- 3 Fault, stop mode after fault always by coasting

Setting the parameter to **0** will deactivate the protection and reset the stall time counter. See **Page A-4**.

Description of Parameters

710 Stall current limit **234567** (P1.7.14)

The current can be set to $0.1 - I_{nMotor} * 2$. For a stall stage to occur, the current must have exceeded this limit. See **Figure 8-49**. The software does not allow entering a greater value than $I_{nMotor} * 2$. If ID113, nominal motor current is changed, this parameter is automatically restored to the default value (I_L). See **Page A-4**.

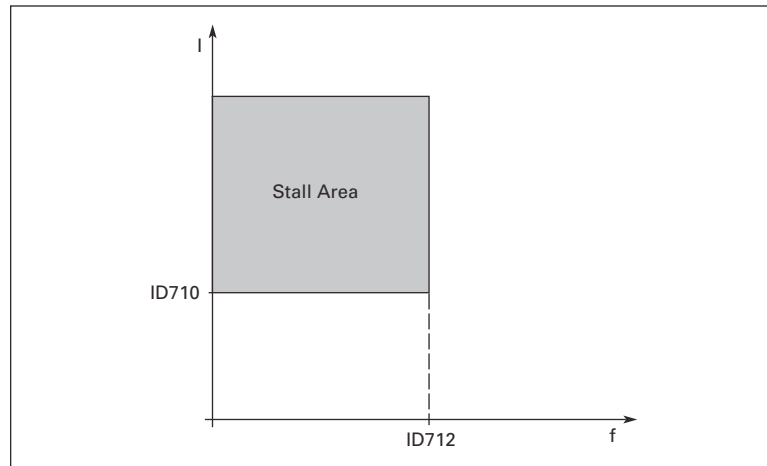

Figure 8-49: Stall Characteristics Settings

711 Stall time **234567** (P1.7.15)

This time can be set between 1.0 and 120.0s.

This is the maximum time allowed for a stall stage. The stall time is counted by an internal up/down counter. If the stall time counter value goes above this limit the protection will cause a trip (see ID709). See **Page A-4**.

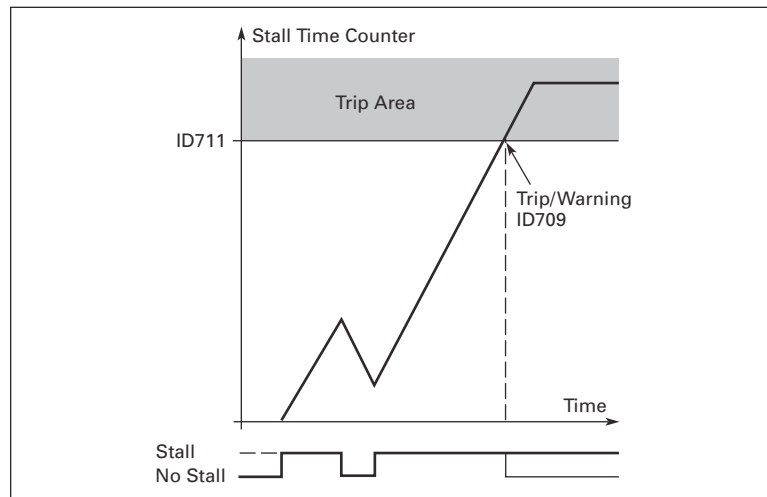

Figure 8-50: Stall Time Count

Description of Parameters

712 Stall frequency limit 234567 (P1.7.16)

The frequency can be set between $1 - f_{mAx}$ (ID102).

For a stall state to occur, the output frequency must have remained below this limit. See **Page A-4**.

713 Underload protection 234567 (P1.7.17)

- 0 No response
- 1 Warning
- 2 Fault, stop mode after fault according to ID506
- 3 Fault, stop mode after fault always by coasting

If tripping is set active the drive will stop and activate the fault stage. Deactivating the protection by setting the parameter to 0 will reset the underload time counter to zero. See **Page A-5**.

714 Underload protection, field weakening area load 234567 (P1.7.18)

The torque limit can be set between 10.0 – 150.0 % $\times T_{nMotor}$.

This parameter gives the value for the minimum torque allowed when the output frequency is above the field weakening point. See **Figure 8-51**.

If you change ID113, nominal motor current, this parameter is automatically restored to the default value. See **Page A-5**.

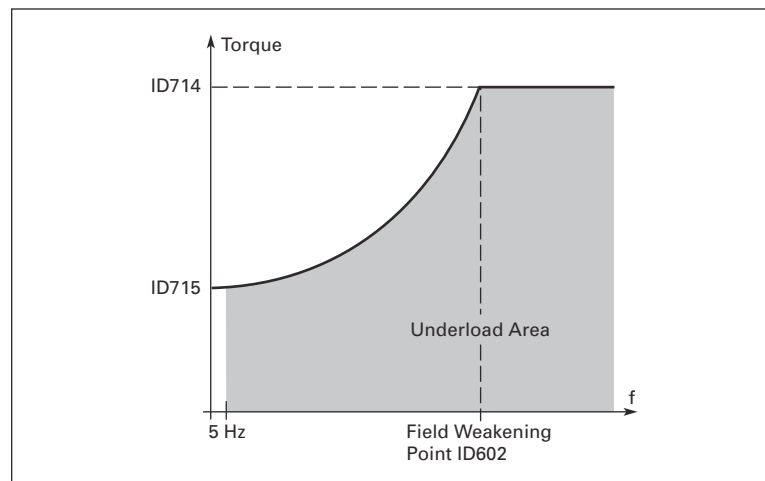

Figure 8-51: Setting of Minimum Load

715 Underload protection, zero frequency load 234567 (P1.7.19)

The torque limit can be set between 5.0 – 150.0 % $\times T_{nMotor}$.

This parameter gives value for the minimum torque allowed with zero frequency. See **Figure 8-51**.

If you change the value of ID113, nominal motor current, this parameter is automatically restored to the default value. See **Page A-5**.

Description of Parameters

716 Underload time 234567 (P1.7.20)

This time can be set between 2.0 and 600.0s.

This is the maximum time allowed for an underload state to exist. An internal up/down counter counts the accumulated underload time. If the underload counter value goes above this limit the protection will cause a trip according to ID713. If the drive is stopped the underload counter is reset to zero. See **Figure 8-52** and **Page A-5**.

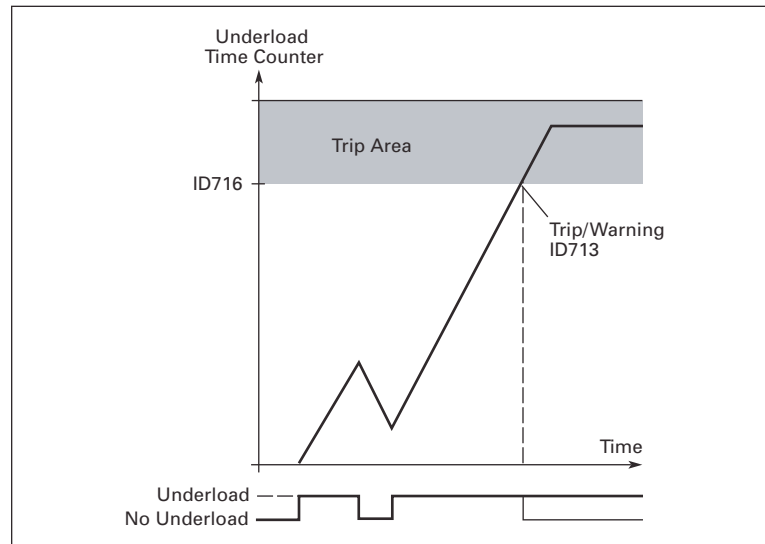

Figure 8-52: Underload Time Counter Function

717 Automatic restart: Wait time 234567 (P1.8.1)

Defines the time before the frequency converter tries to automatically restart the motor after the fault has disappeared.

Description of Parameters

718 Automatic restart: Trial time 234567 (P1.8.2)

The Automatic restart function restarts the frequency converter when the faults selected with ID720 to ID725 have cleared and the waiting time has elapsed.

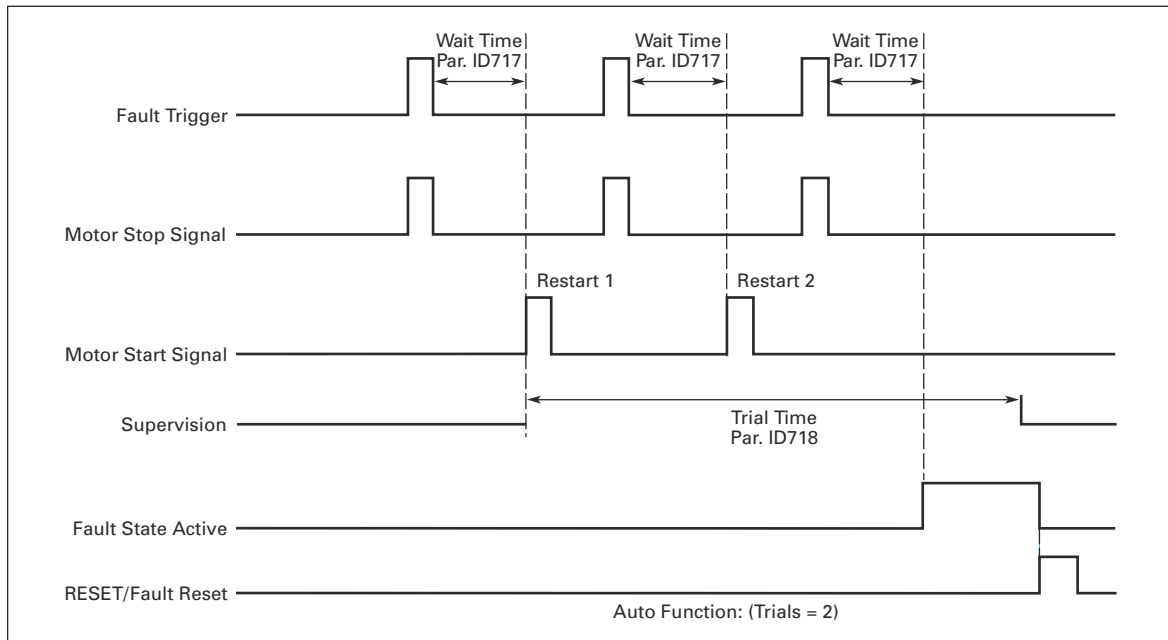

Figure 8-53: Example of Automatic Restarts with Two Restarts

ID720 to ID725 determine the maximum number of automatic restarts during the trial time set by ID718. The time count starts from the first autorestart. If the number of faults occurring during the trial time exceeds the values of ID720 to ID725 the fault state becomes active. Otherwise the fault is cleared after the trial time has elapsed and the next fault starts the trial time count again.

If a single fault remains during the trial time, a fault state is true.

719 Automatic restart: Start function 234567 (P1.8.3)

The Start function for Automatic restart is selected with this parameter. The parameter defines the start mode:

- 0** Start with ramp
- 1** Flying start
- 2** Start according to ID505

Description of Parameters

- 720 Automatic restart: Number of tries after undervoltage fault trip** **234567** (P1.8.4)
- This parameter determines how many automatic restarts can be made during the trial time set by ID718 after an undervoltage trip.
- 0** No automatic restart
- >0** Number of automatic restarts after undervoltage fault. The fault is reset and the drive is started automatically after the DC-link voltage has returned to the normal level.
- 721 Automatic restart: Number of tries after overvoltage trip** **234567** (P1.8.5)
- This parameter determines how many automatic restarts can be made during the trial time set by ID718 after an overvoltage trip.
- 0** No automatic restart after overvoltage fault trip
- >0** Number of automatic restarts after overvoltage fault trip. The fault is reset and the drive is started automatically after the DC-link voltage has returned to the normal level.
- 722 Automatic restart: Number of tries after overcurrent trip** **234567** (P1.8.6)
- This parameter determines how many automatic restarts can be made during the trial time set by ID718.
- Note:** An IGBT temperature fault also included as part of this fault.
- 0** No automatic restart after overcurrent fault trip
- >0** Number of automatic restarts after an overcurrent trip, saturation trip or IGBT temperature fault.
- 723 Automatic restart: Number of tries after reference trip** **234567** (P1.8.7)
- This parameter determines how many automatic restarts can be made during the trial time set by ID718.
- 0** No automatic restart after reference fault trip
- >0** Number of automatic restarts after the analog current signal (4 – 20 mA) has returned to the normal level (≥ 4 mA)
- 725 Automatic restart: Number of tries after external fault trip** **234567** (P1.8.9)
- This parameter determines how many automatic restarts can be made during the trial time set by ID718.
- 0** No automatic restart after External fault trip
- >0** Number of automatic restarts after External fault trip

Description of Parameters

- 726 Automatic restart: Number of tries after motor temperature fault trip** **234567** (P1.8.8)

This parameter determines how many automatic restarts can be made during the trial time set by ID718.

- 0** No automatic restart after Motor temperature fault trip
>0 Number of automatic restarts after the motor temperature has returned to its normal level

- 727 Response to undervoltage fault** **234567** (P1.7.5)

- 1** Warning
2 Fault, stop mode after fault according to ID506
3 Fault, stop mode after fault always by coasting

For the undervoltage limits, see *9000X AF Drives User Manual*, Table 4-2.

- 728 Reference fault: preset frequency reference** **234567** (P1.7.2)

If the value of parameter ID700 is set to 3 and the 4 mA fault occurs, then the frequency reference to the motor is the value of this parameter.

- 730 Input phase supervision** **234567** (P1.7.4)

- 0** No response
1 Warning
2 Fault, stop mode after fault according to ID506
3 Fault, stop mode after fault always by coasting

The input phase supervision ensures that the input phases of the frequency converter have approximately equal currents.

- 731 Automatic restart** **1** (P1.20)

The Automatic restart is used when this parameter is enabled.

- 0** Disabled
1 Enabled

The function resets the following faults (max. three times) (see the *9000X AF Drives User Manual*, Appendix B):

- Σ Overcurrent (F1)
- Σ Overvoltage (F2)
- Σ Undervoltage (F9)
- Σ Frequency converter overtemperature (F14)
- Σ Motor overtemperature (F16)
- Σ Reference fault (F50)

Description of Parameters

- 732 Response to thermistor fault 234567 (P1.7.21)**
- 0** No response
 - 1** Warning
 - 2** Fault, stop mode after fault according to ID506
 - 3** Fault, stop mode after fault always by coasting
- Setting the parameter to **0** will deactivate the protection.
- 733 Response to fieldbus fault 234567 (P1.7.22)**
- This sets the response mode for the fieldbus fault when a fieldbus board is used. For more information, see the respective Fieldbus Board Manual. See ID732.
- 734 Response to slot fault 234567 (P1.7.23)**
- This sets the response mode for a board slot fault caused by a missing or failed board. See ID732.
- 738 Automatic restart: Number of tries after underload fault trip 234567 (P1.8.10)**
- This parameter determines how many automatic restarts can be made during the trial time set by ID718.
- 0** No automatic restart after an Underload fault trip
 - >0** Number of automatic restarts after an Underload fault trip
- 739 Number of PT100 inputs in use 567 (P1.7.24)**
- If a PT100 input board is installed in the frequency converter, this sets the number of PT100 inputs in use. See the *9000X Option Board User Manual*.
- Note:** If the selected value is greater than the actual number of PT100 inputs being used, the display will read 200°C. If the input is short-circuited the displayed value is -30°C.
- 740 Response to PT100 fault 567 (P1.7.25)**
- 0** No response
 - 1** Warning
 - 2** Fault, stop mode after fault according to ID506
 - 3** Fault, stop mode after fault always by coasting
- 741 PT100 warning limit 567 (P1.7.26)**
- Set here the limit at which the PT100 warning will be activated.
- 742 PT100 fault limit 567 (P1.7.27)**
- Set here the limit at which the PT100 fault (F56) will be activated.

Description of Parameters

743	PT100 Numbers 2 See (P1.7.24)	6	(P1.7.28)
744	PT100 Fit Resp 2 See (P1.7.25)	6	(P1.7.29)
745	PT100 Warn Limit 2 See (P1.7.26)	6	(P1.7.30)
746	PT100 Fault Limit 2 See (P1.7.27)	6	(P1.7.31)
755	SafeDisable Mode With parameter, you set the mode of the Safe Disable.	6	(P1.7.34)
770	Ref Fault Select With this parameter, you select the reference source to monitor for a Reference Fault.	6	(P1.7.33)
771	FB MCW Bit 15 Bit 15 of the Fieldbus Main Control Word is used to indicate the status of the signal from the master controller. For example, the PROFIBUS board will set Bit 15 high if the drive is addressed correctly and communicating with the master. Bit 15 is set low and the red LED on the board is turned on if: 1.) The cable is broken or incorrectly connected, 2.) The wrong configuration is set in the master, or 3.) The master is offline or shut down. Set Fault Low for this enhanced monitoring of the PROFIBUS. This bit can affect both the Communication Fault and Reference Fault. Other Fieldbus boards or master controllers may indicate a problem by setting Bit 15 high. In this case, select Fault High to respond to a Bit 15.	2, 3, 4, 5, 6, 7	
850	Fieldbus reference minimum scaling	6	(P1.9.1)
851	Fieldbus reference maximum scaling Use these two parameters to scale the fieldbus reference signal. Setting value limits: $0 \leq ID850 \leq ID851 \leq ID102$. If $ID851 = 0$, custom scaling is not used and the minimum and maximum frequencies are used for scaling. The scaling functions as illustrated in Figure 8-10 . See Page A-5 . Note: Using this custom scaling function also affects the scaling of the actual value.	6	(P1.9.2)

Description of Parameters

852 to 859 **Fieldbus data out selections** **6** (P1.9.3 to P1.9.10)
1 to 8

Using these parameters, you can observe any monitored item or parameter from the fieldbus. Enter the ID number of the item you wish to observe for its value. See **Page A-5**.

Some typical values:

Table 8-13: Typical Monitored Items

Item	Description	Item	Description
1	Output frequency	15	Digital inputs 1,2,3 status
2	Motor speed	16	Digital inputs 4,5,6 status
3	Motor current	17	Digital and relay output status
4	Motor torque	25	Frequency reference
5	Motor power	26	Analog output current
6	Motor voltage	27	AI3
7	DC link voltage	28	AI4
8	Unit temperature	31	AO1 (expander board)
9	Motor temperature	32	AO2 (expander board)
13	AI1	37	Active fault 1
14	AI2	—	—

876 **FB Data In1 Sel** **6** (P1.9.11)

With this parameter, you select the ID of the parameter to write to with DB Data In1. The data is only sent to the drive on a change. This function is disabled if “Fieldbus” is selected in P1.10.4, Torq Ref Select.

877 **FB Data In2 Sel** **6** (P1.9.12)

With this parameter, you select the ID of the parameter to write to with DB Data in2. The data is only sent to the drive on a change. This function is disabled if “Fieldbus” is selected by any parameter in Group 1.2.6, Free AI Select.

1001 **Number of auxiliary drives** **7** (P1.9.1)

With this parameter, the number of auxiliary drives in use will be defined. The functions controlling the auxiliary drives (ID458 to ID462) can be programmed to relay outputs or digital output. By default, one auxiliary drive is in use and it is programmed to relay output RO1 at B.1.

1002 **Start frequency, auxiliary drive 1** **7** (P1.9.2)

The frequency of the drive controlled by the frequency converter must exceed the limit defined with these parameters with 1 Hz before the auxiliary drive is started. The 1 Hz overdraft makes a hysteresis to avoid unnecessary starts and stops. See **Figure 8-54**. See also ID101 and ID102.

Description of Parameters

1003 Stop frequency, auxiliary drive 1 7 (P1.9.3)

The frequency of the drive controlled by the frequency converter must fall with 1 Hz below the limit defined with these parameters before the auxiliary drive is stopped. The stop frequency limit also defines the frequency to which the frequency of the drive controlled by the frequency converter is dropped after starting the auxiliary drive. See **Figure 8-54**.

1004 Start frequency, auxiliary drive 2 7 (P1.9.4)

1005 Stop frequency, auxiliary drive 2 7 (P1.9.5)

1006 Start frequency, auxiliary drive 3 7 (P1.9.6)

1007 Stop frequency, auxiliary drive 3 7 (P1.9.7)

1008 Start frequency, auxiliary drive 4 7 (P1.9.8)

1009 Stop frequency, auxiliary drive 4 7 (P1.9.9)

See ID1002 and ID1003.

Description of Parameters

1010 Start delay of auxiliary drives 7 (P1.9.10)

The frequency of the drive controlled by the frequency converter must remain above the start frequency of the auxiliary drive for the time defined with this parameter before the auxiliary drive is started. The delay defined applies to all auxiliary drives. This prevents unnecessary starts caused by the start limit being momentarily exceeded. See **Figure 8-54**.

1011 Stop delay of auxiliary drives 7 (P1.9.11)

The frequency of the drive controlled by the frequency converter must remain below the stop limit of the auxiliary drive for the time defined with this parameter before the auxiliary drive is stopped. The delay defined applies to all auxiliary drives. This prevents unnecessary stops caused by the stop limit frequency momentarily dropping below the limit. See **Figure 8-54**.

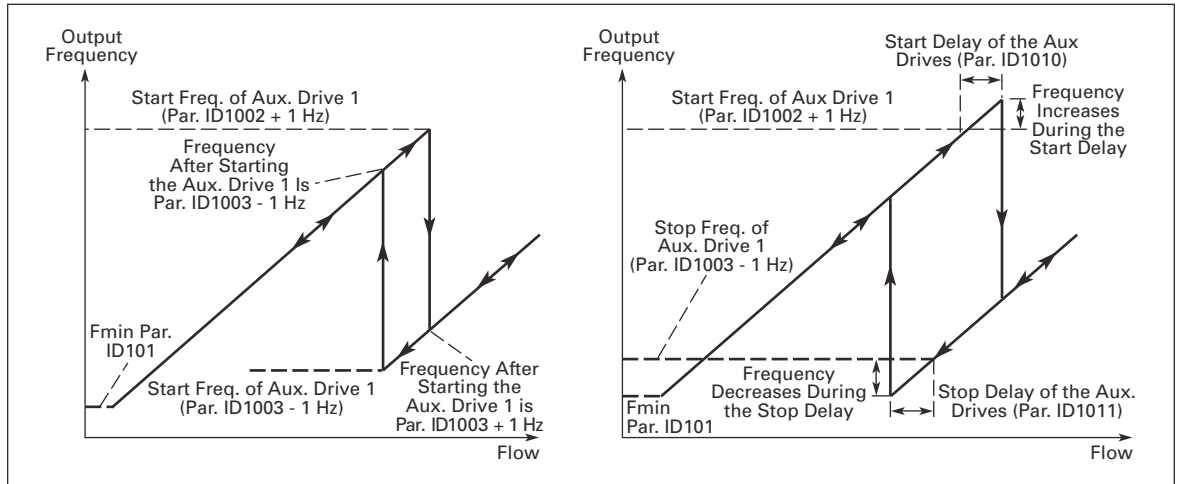

Figure 8-54: Example of Parameter Setting
Variable Speed Drive and One Auxiliary Drive

Description of Parameters

1012	Reference step after start of auxiliary drive 1	7	(P1.9.12)
1013	Reference step after start of auxiliary drive 2	7	(P1.9.13)
1014	Reference step after start of auxiliary drive 3	7	(P1.9.14)
1015	Reference step after start of auxiliary drive 4	7	(P1.9.15)

The reference step will always be automatically added to the reference value when the corresponding auxiliary drive is started. With the reference steps, e.g. the pressure loss in the piping caused by the increased flow can be compensated. See **Figure 8-55**.

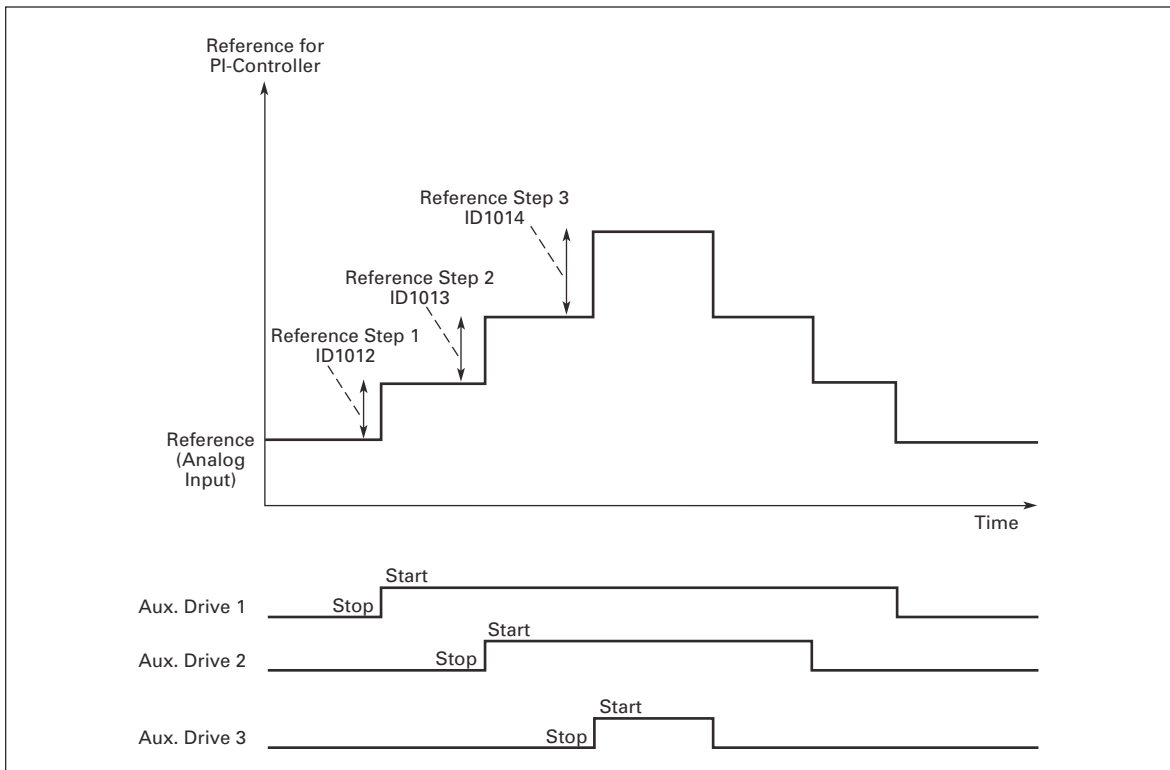

Figure 8-55: Reference Steps after Starting Auxiliary Drives

1016	Sleep frequency	57	(P1.1.15)
-------------	------------------------	-----------	------------------

The frequency converter is automatically stopped if the frequency of the drive falls below the Sleep level defined with this parameter for a time greater than that determined by ID1017. During the Stop state, the PID controller is operating switching the frequency converter back to the Run state when the actual value signal either falls below or exceeds (ID1019) the Wake-up level determined by ID1018. See **Figure 8-56**.

Description of Parameters

Table 8-14: Selectable Wake-Up Functions

Parameter Value	Function	Limit	Description
0	Wake-up happens when actual value goes below the limit	The limit defined with ID1018 is in percent of the maximum actual value	<p>Actual Value Signal</p> <p>100%</p> <p>ID1018=30%</p> <p>Time</p> <p>Start Stop</p>
1	Wake-up happens when actual value exceeds the limit	The limit defined with ID1018 is in percent of the maximum actual value	<p>Actual Value Signal</p> <p>100%</p> <p>ID1018=60%</p> <p>Time</p> <p>Start Stop</p>
2	Wake-up happens when actual value goes below the limit	The limit defined with ID1018 is in percent of the current value of the reference signal	<p>Actual Value Signal</p> <p>100%</p> <p>Reference=50%</p> <p>ID1018=60%</p> <p>Limit=60%* Reference=30%</p> <p>Time</p> <p>Start Stop</p>
3	Wake-up happens when actual value exceeds the limit	The limit defined with ID1018 is in percent of the current value of the reference signal	<p>Actual Value Signal</p> <p>100%</p> <p>ID1018=140%</p> <p>Limit=140%* Reference=70%</p> <p>Reference=50%</p> <p>Time</p> <p>Start Stop</p>

Description of Parameters

1020 PID controller bypass 7 (P1.9.16)

With this parameter, the PID controller can be programmed to be bypassed. Then the frequency of the controlled drive and the starting points of the auxiliary drives are defined according to the actual value signal. See **Figure 8-57**.

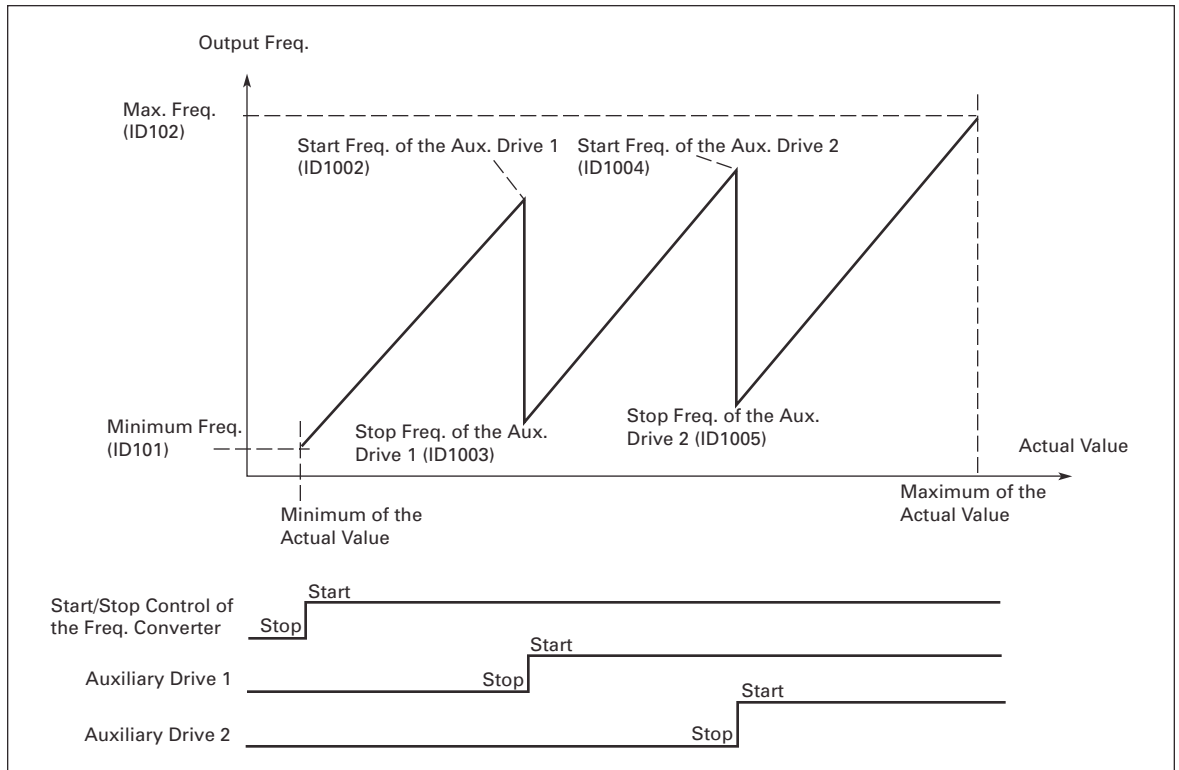

Figure 8-57: Example of Adjustable Frequency Drive and Two Auxiliary Drives with Bypassed PID Controller

- 1021 Analog input selection for input pressure measurement 7 (P1.9.17)**
- 1022 Input pressure high limit 7 (P1.9.18)**
- 1023 Input pressure low limit 7 (P1.9.19)**
- 1024 Output pressure drop value 7 (P1.9.20)**

In pressure increase stations there may be need for decreasing the output pressure if the input pressure decreases below a certain limit. The input pressure measurement which is needed is connected to the analog input selected with ID1021. See **Figure 8-58**.

Description of Parameters

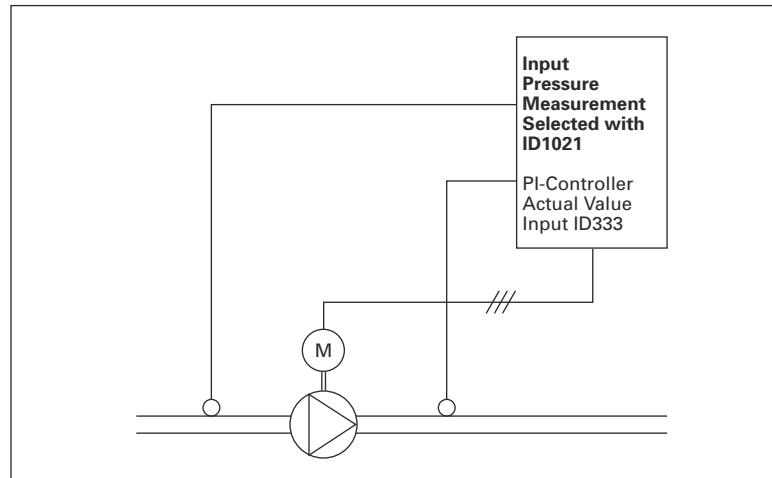

Figure 8-58: Input and Output Pressure Measuring

ID1022 and ID1023 are used to select the limits for the area of the input pressure, where the output pressure is decreased. The values are in percent of the input pressure measurement maximum value. With ID1024 the value for the output pressure decrease within this area can be set. The value is in percent of the reference value maximum. See **Figure 8-59**.

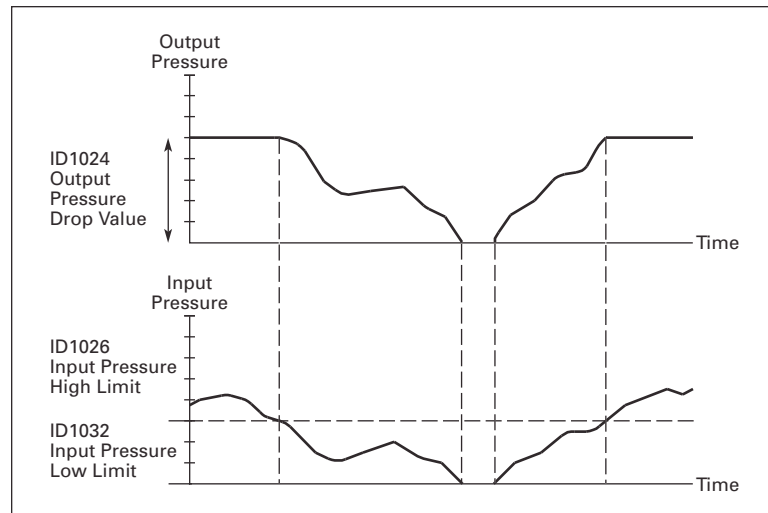

Figure 8-59: Output Pressure Behavior Depending on Input Pressure and Parameter Settings

Description of Parameters

- 1025 Frequency drop delay after starting auxiliary drive** 7 (P1.9.21)
- 1026 Frequency increase delay after stopping auxiliary drive** 7 (P1.9.22)

If the speed of auxiliary drive increases slowly (e.g. in soft starter control) then a delay between the start of auxiliary drive and the frequency drop of the adjustable frequency drive will make the control smoother. This delay can be adjusted with ID1025.

In the same way, if the speed of the auxiliary drives decreases slowly a delay between the auxiliary drive stop and the frequency increase of the adjustable frequency drive can be programmed with ID1026. See **Figure 8-60**.

If either of the values of ID1025 or ID1026 is set to maximum (300.0 s) no frequency drop nor increase takes place.

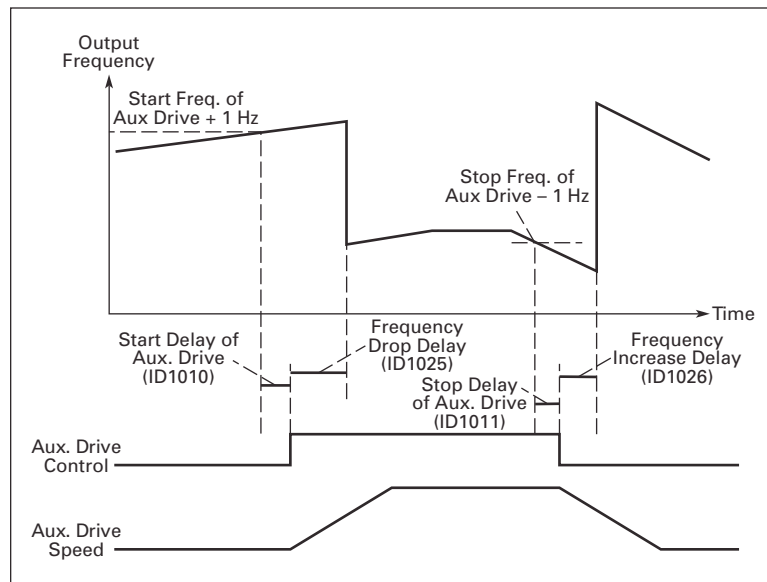

Figure 8-60: Frequency Drop and Increase Delays

- 1027 Autochange** 7 (P1.9.24)
- 0 Autochange not used
- 1 Autochange used

Description of Parameters

1028 Autochange/interlocks automatics selection 7 (P1.9.25)

0 Automatics (autochange/interlockings) applied to auxiliary drives only

The drive controlled by the frequency converter remains the same. Only the mains contactor is needed for each drive. See **Figure 8-61**.

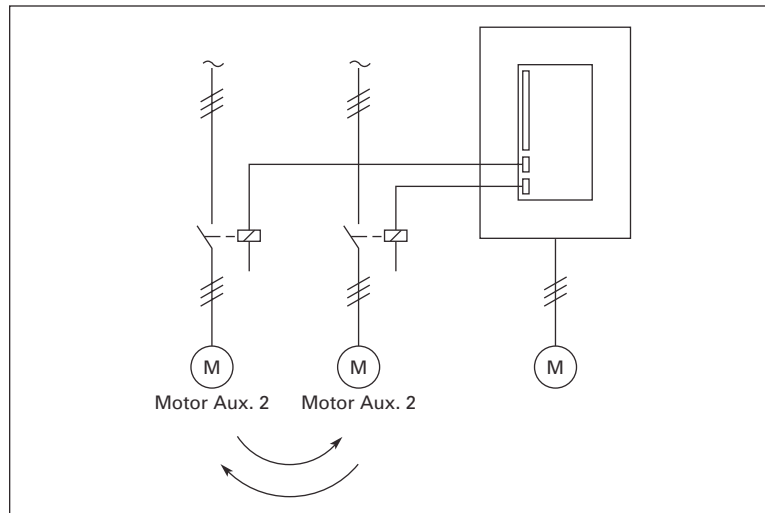

Figure 8-61: Autochange Applied to Auxiliary Drives Only

1 All drives included in the autochange/interlockings sequence

The drive controlled by the frequency converter is included in the automatics and two contactors are needed for each drive to connect it to the mains or the frequency converter. See **Figure 8-62**.

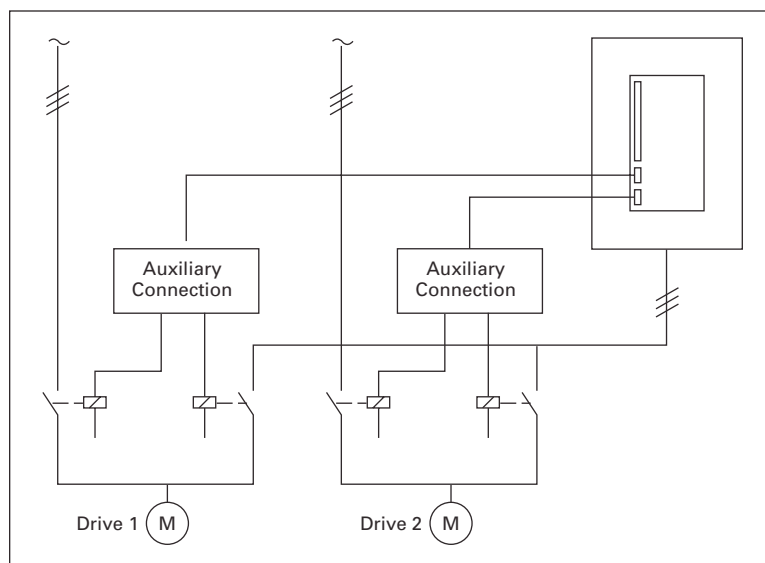

Figure 8-62: Autochange with All Drives

Description of Parameters

1029 Autochange interval 7 (P1.9.26)

After the expiration of the time defined with this parameter, the autochange function takes place if the capacity used lies below the level defined with ID1031 (*Autochange frequency limit*) and ID1030 (*Maximum number of auxiliary drives*). Should the capacity exceed the value of ID1031, the autochange will not take place before the capacity goes below this limit.

- The time count is activated only if the Start/Stop request is active.
- The time count is reset after the autochange has taken place.

See **Figure 8-63**.

1030 Maximum number of auxiliary drives 7 (P1.9.27)

1031 Autochange frequency limit 7 (P1.9.28)

These parameters define the level below which the capacity used must remain for autochange to take place.

This level is defined as follows:

- If the number of running auxiliary drives is smaller than the value of ID1030 the autochange function can take place.
- If the number of running auxiliary drives is equal to the value of ID1030 and the frequency of the controlled drive is below the value of ID1031 the autochange can take place.
- If the value of ID1031 is 0.0 Hz, the autochange can take place only in rest position (Stop and Sleep) regardless of the value of ID1030.

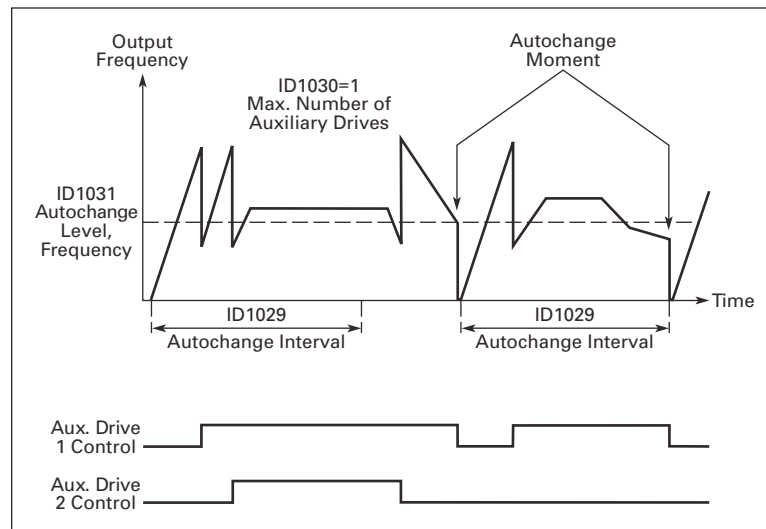

Figure 8-63: Autochange Interval and Limits

Description of Parameters

1032 Interlock selection 7 (P1.9.23)

With this parameter you can activate or deactivate the feedback signal from the drives. The interlock feedback signals come from the switches that connect the motors to the automatic control (frequency converter), directly to the mains line or place them in the off-state. The interlock feedback functions are connected to the digital inputs of the frequency converter. Program ID426 to ID430 to connect the feedback functions to the digital inputs. Each auxiliary drive must be connected to its own interlock input. The Pump and fan control only controls those motors whose interlock input is active.

0 Interlock feedback not used

The frequency converter receives no interlock feedback from the auxiliary drives

1 Update of autochange order in Stop

The frequency converter receives interlock feedback from the auxiliary drives. In case one of the auxiliary drives is, for some reason, disconnected from the system and eventually re-connected, it will be placed last in the autochange line without stopping the system. However, if the autochange order now becomes, for example, [P1 → P3 → P4 → P2], it will be updated in the next Stop (autochange, sleep, stop, etc.).

Example:

[P1 → P3 → P4] → [P2 LOCKED] → [P1 → P3 → P4 → P2] → [SLEEP] → [P1 → P2 → P3 → P4]

2 Update of order immediately

The frequency converter receives interlock feedback from the auxiliary drives. At re-connection of an auxiliary drive to the autochange line, the automatics will stop all motors immediately and re-start with a new setup.

Example:

[P1 → P2 → P4] → [P3 LOCKED] → [STOP] → [P1 → P2 → P3 → P4]

1033 Actual value special display 7 (P1.9.29)

minimum

1034 Actual value special display 7 (P1.9.30)

maximum

1035 Actual value special display 7 (P1.9.31)

decimals

These parameters set the minimum and maximum values and the number of decimals of the actual value special display. Observe the actual value display in menu **M1, Monitoring values**.

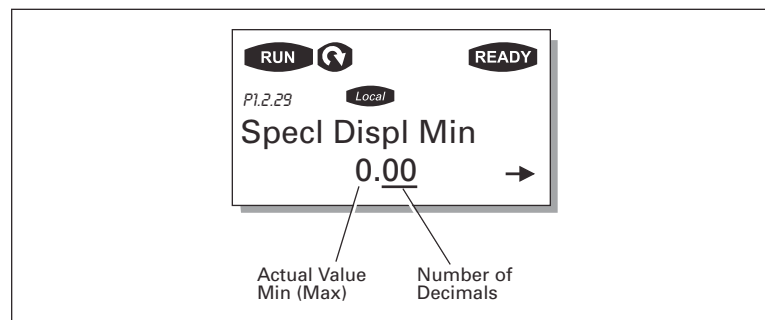

Figure 8-64: Actual Value Special Display

Description of Parameters

- 1354 FB WatchdogDelay** **6** (P1.7.32)
With this parameter, you activate the WatchDog timer. If bit 11 of the Main Control Word stops cycling for this set period of time, an FB Communication Fault occurs.
- 1522 High Speed Mode** **6** (P1.4.14)
Changes maximum fundamental output frequency from 320.0 Hz to 600.0 Hz.
- 1680 Safe Disable** **6** (P1.3.3.29)
With this parameter, you select the digital output to show the status of the Safe Disable. (Requires SPX drive and special card in Slot B.)
- 1681 ChargeSWState** **6** (P1.3.3.30)
With this parameter, you select the digital output to show the status of the DC Bus charge. Can be used to close contactor when CPX precharge is complete.
- 1685 LoRemButtonActive** **234567**
With this parameter, you can disable the local remote button on the keypad if a digital input is used to select local and remote mode.
- 1686 CPX Temperature Fault** **6** (P1.2.7.22)
Contact open: Fault is displayed and motor stopped.
- 1707 Hide Operate Menu** **234567**
With this parameter, you can disable the Keypad Operate Menu so the Multimonitor Menu can be used to display three monitor values at a time. If one of the values is a reference, the up/down arrows will adjust the reference as with the Operate Menu.

Description of Parameters

Keypad Control Parameters

Unlike the parameters listed above, these parameters are located in the **M2** menu of the control keypad. The reference parameters do not have an ID number.

114 STOP button activated (P2.4, P2.6)

To make the STOP button a “hotspot” which always stops the drive regardless of the selected control place, set the value of this parameter to **1**.

See also ID125.

123 Keypad direction (P2.3)

0 Forward: The rotation of the motor is forward, when the keypad is the active control place.

1 Reverse: The rotation of the motor is reversed, when the keypad is the active control place.

For more information, see the *9000X AF Drives User Manual, Chapter 5, Keypad Control Menu (M2)*.

R3.2 Keypad reference (R2.2)

The frequency reference can be adjusted from the keypad with this parameter.

The output frequency can be copied as the keypad reference by pushing the STOP button for 3 seconds when you are on any of the pages of menu **M2**. For more information, see the *9000X AF Drives User Manual, Chapter 5, Keypad Control Menu (M2)*.

R3.4 PID reference 1 **57** (R2.4)

The PID controller keypad reference can be set between 0% and 100%. This reference value is the active PID reference if ID332 = 2.

R3.5 PID reference 2 **57** (R2.5)

The PID controller keypad reference 2 can be set between 0% and 100%. This reference is active if the DIN5 function = 13 and the DIN5 contact is closed.

R3.5 Torque reference **6** (R2.5)

Defines the torque reference from 0.0 to 100.0%.

1688 Operate Menu Hide — Disables operate menu to use monitor menu without auto return to operate.

August 2010

Appendix A — Additional Information

In this chapter you will find additional information on special parameter groups. Such groups are:

- Parameters of External Brake Control with Additional Limits (see below)
- Closed Loop Parameters (see **Page A-3**)
- Advanced Open Loop Parameters (see **Page A-4**)
- Parameters of Motor Thermal Protection (see **Page A-4**)
- Parameters of Stall Protection (see **Page A-4**)
- Parameters of Underload Protection (see **Page A-5**)
- Fieldbus Control Parameters (see **Page A-5**)

External Brake Control with Additional Limits

ID315, ID316, ID346 to ID349, ID352, ID353

The external brake used for additional braking can be controlled through ID315, ID316, ID346 to ID349 and ID352/ID353. Selecting On/Off Control for the brake, defining the frequency or torque limit(s) the brake should react to and defining the Brake-On/-Off delays will allow an effective brake control. See **Figure A-1**.

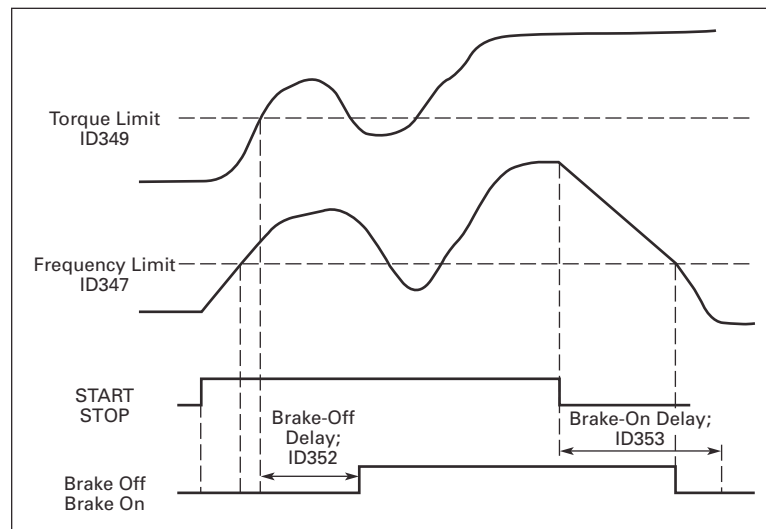

Figure A-1: Brake Control with Additional Limits

In **Figure A-1** the brake control is set to react to both the torque supervision limit (ID349) and frequency supervision limit (ID347). Additionally, the same frequency limit is used for both brake-off and brake-on control by giving ID346 the value **4**. Use of two different frequency limits is also possible. Then ID315 and ID346 must be given the value **3**.

Brake-off: In order for the brake to release, three conditions must be fulfilled: 1) the drive must be in Run state, 2) the torque must be over the set limit (if used) and 3) the output frequency must be over the set limit (if used).

Appendix A

Brake-on: Stop command activates the brake delay count and the brake is closed when the output frequency falls below the set limit (ID315 or ID346). As a precaution, the brake closes when the brake-on delay expires, at the latest.

Note: A fault or Stop state will close the brake immediately without a delay.

See **Figure A-2**.

Note: It is strongly advisable that the brake-on delay be set longer than the ramp time in order to avoid damaging of the brake.

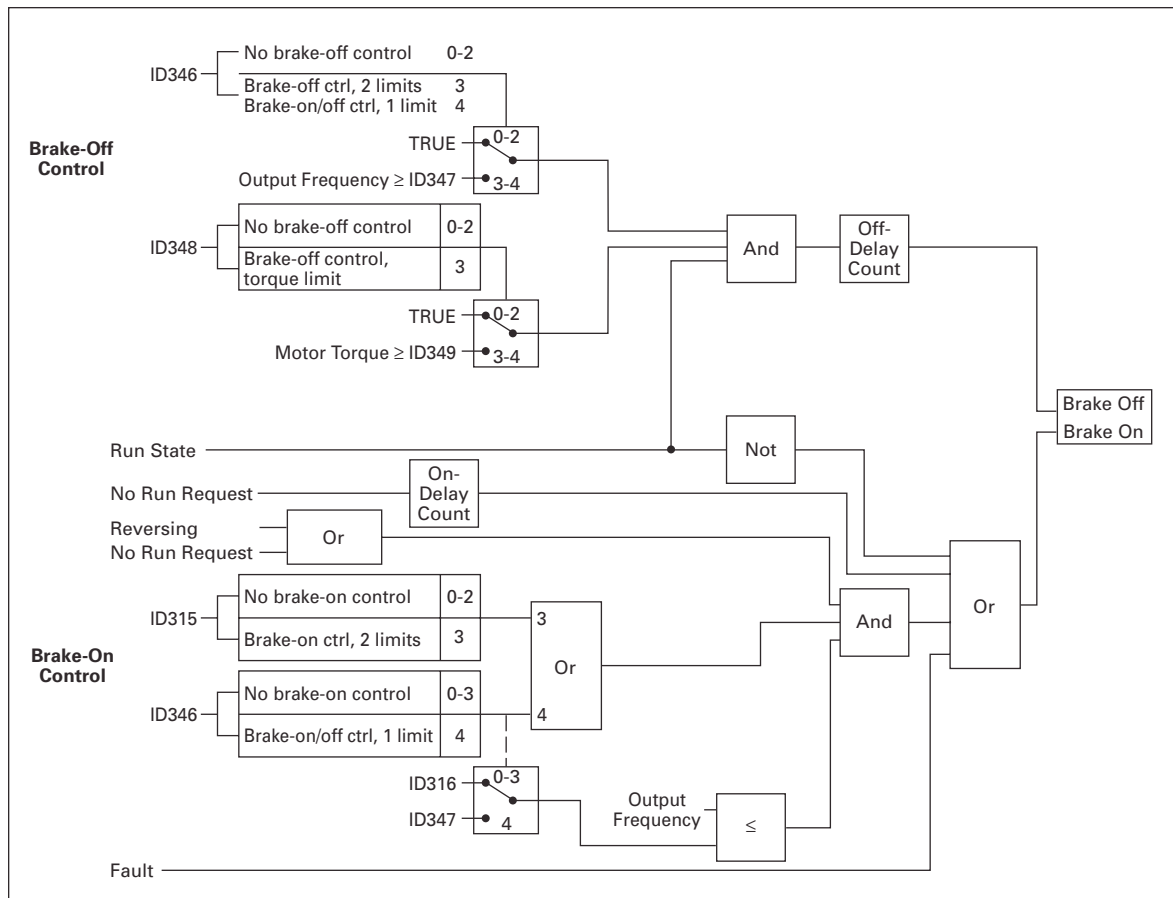

Figure A-2: Brake Control Logic

Appendix A

Closed Loop Parameters

ID612 to ID621

Select the Closed loop control mode by setting value **3** or **4** for ID600.

Closed loop control mode (see **Page 8-57**) is used when enhanced performance near zero speed and better static speed accuracy with higher speeds are needed. Closed loop control mode is based on “rotor flux oriented current vector control”. With this controlling principle, the phase currents are divided into a torque producing current portion and a magnetizing current portion. Thus, the squirrel cage induction machine can be controlled in a fashion of a separately excited DC motor.

Note: These parameters can be used with SVXP drive only.

Example: Motor Control Mode = 3 (Closed loop speed control)

This is the usual operation mode when fast response times, high accuracy or controlled run at zero frequencies are needed. Encoder board should be connected to slot C of the control unit. Set the encoder P/R-parameter (P7.3.1.1). Run in open loop and check the encoder speed and direction (V7.3.2.2). Change the direction parameter (P7.3.1.2) or switch the phases of motor cables if necessary. Do not run if encoder speed is wrong. Program the no-load current to ID612 and set ID619 (Slip Adjust) to get the voltage slightly above the linear V/Hz-curve with the motor frequency at about 66% of the nominal motor frequency. The Motor Nominal Speed parameter (ID112) is critical. The Current Limit parameter (ID107) controls the available torque linearly in relative to motor nominal current.

Appendix A

Parameters of Motor Thermal Protection

ID704 to ID708

General

The motor thermal protection is to protect the motor from overheating. The Eaton drive is capable of supplying higher than nominal current to the motor. If the load requires this high current there is a risk that the motor will be thermally overloaded. This is the case especially at low frequencies. At low frequencies the cooling effect of the motor is reduced as well as its capacity. If the motor is equipped with an external fan the load reduction at low speeds is small.

The motor thermal protection is based on a calculated model and it uses the output current of the drive to determine the load on the motor.

The motor thermal protection can be adjusted with parameters. The thermal current I_T specifies the load current above which the motor is overloaded. This current limit is a function of the output frequency.

The thermal stage of the motor can be monitored on the control keypad display. See *9000X AF Drives User Manual, Chapter 5*.

 **CAUTION**

The calculated model does not protect the motor if the airflow to the motor is reduced by blocked air intake grill.

Parameters of Stall Protection

ID709 to ID712

General

The motor stall protection protects the motor from short time overload situations such as one caused by a stalled shaft. The reaction time of the stall protection can be set shorter than that of motor thermal protection. The stall state is defined with two parameters, ID710 (Stall current) and ID712 (Stall frequency limit). If the current is higher than the set limit and output frequency is lower than the set limit, the stall state is true. There is actually no real indication of the shaft rotation. Stall protection is a type of overcurrent protection.

Appendix A

Parameters of Underload Protection

ID713 to ID716

General

The purpose of the motor underload protection is to ensure that there is load on the motor when the drive is running. If the motor loses its load there might be a problem in the process, e.g. a broken belt or a dry pump.

Motor underload protection can be adjusted by setting the underload curve with parameters ID714 (Field weakening area load) and ID715 (Zero frequency load), see below. The underload curve is a squared curve set between the zero frequency and the field weakening point. The protection is not active below 5 Hz (the underload time counter is stopped).

The torque values for setting the underload curve are set in percentage which refers to the nominal torque of the motor. The motor's name plate data, parameter motor nominal current and the drive's nominal current I_H are used to find the scaling ratio for the internal torque value. If other than nominal motor is used with the drive, the accuracy of the torque calculation decreases.

Fieldbus Control Parameters

ID850 to ID859

The Fieldbus control parameters are used when the frequency or the speed reference comes from the fieldbus (Modbus, Profibus, DeviceNet, etc.). With the Fieldbus Data Out Selection 1 – 8, you can monitor values from the fieldbus.

Eaton's Electrical Sector is a global leader in power distribution, power quality, control and automation, and monitoring products. When combined with Eaton's full-scale engineering services, these products provide customer-driven PowerChain Management® solutions to serve the power system needs of the data center, industrial, institutional, public sector, utility, commercial, residential, IT, mission critical, alternative energy and OEM markets worldwide.

PowerChain Management solutions help enterprises achieve sustainable and competitive advantages through proactive management of the power system as a strategic, integrated asset throughout its life cycle, resulting in enhanced safety, greater reliability and energy efficiency. For more information, visit www.eaton.com/electrical.

Eaton Corporation
Electrical Sector
1111 Superior Ave.
Cleveland, OH 44114
United States
877-ETN-CARE (877-386-2273)
Eaton.com

© 2010 Eaton Corporation
All Rights Reserved
Printed in USA
Publication No. MN04004001E / Z10157
August 2010



**PowerChain
Management®**

PowerChain Management is a registered trademark of Eaton Corporation.

All other trademarks are property of their respective owners.



Powering Business Worldwide