



Description

Standard GuardShield

The Allen-Bradley Guardmaster GuardShield safety light curtain is an economical, fully featured, Type 4 safety light curtain in a uniquely styled housing. GuardShield safety light curtains are general-purpose presence sensing devices designed for use on hazardous machinery providing point of operation, as well as perimeter and access guarding. This self-contained, two-box, safety light curtain has DIP-switch selectable operating modes and is available in both 14 mm and 30 mm resolutions.

Modes of operation such as fixed and floating blanking, beam coding, start/restart interlock, external device monitoring (EDM), and machine test signal, are selected by DIP-switch settings. These DIP-switches are located beneath a security door, which are conveniently located on both the transmitter and receiver end caps.

The GuardShield's torsionally rigid, extruded aluminium, polyurethane powder-coated housing, combined with an environmental rating of IP65, allows the GuardShield to be used in guarding applications across a broad range of industries.



Remote Teach GuardShield

The GuardShield Remote Teach system provides a remote means of changing a fixed blanking configuration within the GuardShield safety light curtain. This keyswitch box eliminates the need to open the GuardShield receiver door and perform the Teach function.

The three-position key switch simulates the opening of the GuardShield receiver door, teaching the GuardShield light curtain the new fixed blanking area, closing the door and returning to the run mode of operation.

The IP65 rated key switch box is provided with a steel mounting back plate to facilitate mounting of the box in proximity to the GuardShield receiver. It is necessary to see the receiver LEDs when performing the teach function.

Cascadable GuardShield System

A cascadable GuardShield safety light curtain is a standard GuardShield safety light curtain in 14 and 30 mm resolutions with additional M12 connectors located on top of each safety light curtain. The connector on the top of the safety light curtains allow the interconnection of up to a total of three pair of GuardShield safety light curtains with a common pair of OSSDs. The ability to interconnect GuardShield pairs reduces overall system wiring and simplifies the safety circuit resulting in a lower overall cost of a multiple safety light curtain system. This product configurability also allows a GuardShield safety light curtain system to protect multiple sides of a machine or simply adds flexibility when positioning GuardShield in various applications.

The complete cascading GuardShield system has the full functionality of a standard GuardShield (beam coding, EDM, start/restart interlock, fixed and floating blanking). There are a couple of operating modes which can not be configured in the middle and end segments (EDM and Start/Restart Interlock) and must only be configured in the host (first) pair. The system will still have these operating modes active if configured in the host or first GuardShield pair. This host or first pair is the pair of cascading GuardShield light curtains, which have the output cordsets connected and wired to the safety relay, safety PLC or FSDs. Configuring of the EDM operating mode in the end and middle segments will cause the system to go to a lock-out condition after the first interruption of the sensing field. Configuration of the start/restart interlock operating mode in the end and middle segments will cause the system to stay in a red condition awaiting reset after the interruption of the sensing field.

The cascading GuardShield safety light curtains are ordered as pairs (transmitter and receiver) and are shipped under one cat. no. After selecting the appropriate pair of cat. nos. for a cascading GuardShield system, select the interconnecting transmitter and receiver patchcord cat. nos. to connect the GuardShield pairs. The transmitter patchcord is a 4-pin M12 patchcord offered in lengths of 1/3 meter, 1 meter and 2 meters. The receiver patchcord is an 8-pin M12 patchcord offered in lengths of 1/3 meter, 1 meter, and 2 meters.

If the end pair of a cascading system is a cascading pair of GuardShield light curtains, it is necessary to attach a termination adaptor to the top M12 connector located on the receiver. Be sure to order all other required interfaces and accessories.

2-Opto-electronics

Presence Sensing Safety Devices

POC Type 4 Safety Light Curtains

GuardShield

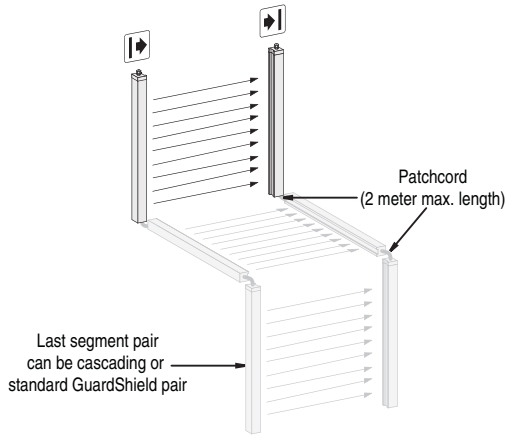

GuardShield with Integrated Laser Alignment System

The GuardShield POC and GuardShield POC cascading light curtains are offered with an integrated laser alignment system consisting of a Class 1, eye safe, constantly powered laser located in the top of the GuardShield transmitter and at the bottom of the GuardShield receiver. There are targets located across from each laser that help facilitate alignment of the light curtain when the laser is emitting visible light.

Each laser emits a low level of visible light. Simply placing a finger or opaque object in front of the laser reflects the laser light back to a photo sensor. This photo sensor causes the laser to switch state from a barely visible low level of emission to a higher level of emission of visible light. Interrupting the visible light below the finger symbol will cause the laser to change state back to a low level of light emission. The visible light will also change to a low level after five minutes.

The Integrated Laser Alignment system also quickly helps with the re-alignment of pairs when units are knocked out of alignment during the course of the work process or when corner mirrors are used.

The GuardShield and Cascadable GuardShield are offered in 14 and 30 mm resolutions in protective heights from 320 to 1600 mm. The 160 and 1760 mm protective heights are not offered with the integrated laser alignment systems.

ArmorBlock Guard I/O Connectivity

The GuardShield POC and GuardShield Cascadable light curtains are also offered with the Class 1, eye safe, integrated laser alignment system and connectivity to ArmorBlock Guard I/O. The receiver of these light curtains has a five-pin M12 quick-disconnect connector wired to connect to the 1732DS ArmorBlock I/O module, allowing the GuardShield's OSSDs to operate over a DeviceNet safe network.

This version of the GuardShield has limited configurability, i.e., only beam coding, fixed and floating blanking can be configured by setting the appropriate DIP switches and performing the teach function. EDM, Start/Restart interlock, and the auxiliary output are not available in these models.

You can use the ArmorBlock Guard I/O with any safety controller that communicates on DeviceNet using CIP Safety for the control and monitoring of safety circuits. ArmorBlock Guard I/O detects circuit failures at each I/O point while providing detailed diagnostics directly to the controller. With CIP Safety, you can easily integrate safety and standard control systems by using safety and standard messages on the same wire.

The 1732DS ArmorBlock Guard I/O family consists of 24V DC digital I/O modules that communicate on DeviceNet networks.

Up to three GuardShield POC segments can be interconnected.

The upper and lower limit of the protective field is shown by markings on the housings.

The width of the protective field is derived from the length of the light path between transmitter and receiver and must not exceed the maximum rated width of the protective field: 7 m for 14 mm (22.9 ft for 0.55 in.), 18 m for 30 mm (59.0 ft for 1.18 in.).

Cascading segments are offered in protective heights from 320...1760 mm in both 14 mm and 30 mm resolutions. Cascading segments of 160 mm are not offered, however; a 160 mm GuardShield can be used as the last segment in a cascading system.

A maximum of three GuardShield light curtains can be interconnected with a common pair of OSSDs. The maximum number of beams allowed in a cascading system is 528 beams, which equates to three 1760 mm cascading GuardShields in 14 mm resolution. The individual segments can have mixed resolutions, e.g., 14 mm and 30 mm as long as the pairs have the same protective heights and resolutions.

The response time of a cascading GuardShield system is the longest response time of any pair in the cascading system. For example, if the response time of each pair in the cascading system is 20 ms, then the cascading system's response time is 20 ms.

Cascading segments can be used as standalone light curtain pairs or can have up to three segments interconnected. These cascading segments all function as independent light curtains.

IMPORTANT

When cascading segments are used as standalone pairs or as the last segment in a cascading system, it is necessary to use a termination plug on the top connector of the GuardShield cascading receiver. It is also possible to use a standard GuardShield Type 4 POC pair as the last segment in a cascading system.

Features

Standard GuardShield

- Fixed blanking—teachable
- Floating blanking
 - One-beam floating blanking on 30 mm resolution
 - Two-beam floating blanking on 14 mm resolution
- Beam coding
- External Device Monitoring (EDM)
- Start/restart interlock
- M12 quick-disconnect connectors
- 160 to 1760 mm in 160 mm increments
- Standard GuardShield can be used as last segment pair in a cascading system

Standard GuardShield with Integrated Laser Alignment

- Fixed blanking—teachable
- Floating blanking
- Beam coding
- M12 quick-disconnect connectors
- Ease of alignment at installation with visible laser alignment
- 320...1600 mm in 160 mm increments
- 14 and 30 mm resolutions

Remote Teach GuardShield

- Three-position momentary key switch
- IP65 rated key switch box
- Y connector for quick-disconnect connections
- Standard GuardShield cables
- Allows quick and efficient reteaching of fixed blanked areas
- 160 to 1760 mm in 160 mm increments

Cascadable GuardShield System

- Easy to interconnect light curtains up to three 1760 mm segment pairs
- No increase in system response time

ArmorBlock Guard I/O GuardShield

- Fixed blanking—teachable
- Floating blanking
- Up to three cascading pairs can connect to ArmorBlock Guard I/O
- Beam coding
- M12 quick-disconnect connectors
- DeviceNet safe network connectivity
- 320...1600 mm in 160 mm increments

Specifications

Safety Ratings	
Standards	IEC/EN 61496 Parts 1 & 2, UL 61496 Parts 1 & 2, UL 1998
Safety Classification	Type 4 per IEC/EN61496. Category 4 device per EN 954-1, SIL 3 per IEC 61508, PLe per EN/ISO 13849
Certifications	cULus, UL 61496, UL 1998, TÜV, and CE Marked for all applicable directives
Power Supply	
Input Power, Max.	24V DC ±20%
Maximum Residual Ripple	0.05 Vss
Power Consumption	0.4 A max (no load)
Outputs	
Safety Outputs	2 OSSD, 0.5 A, short-circuit protected
Non-Safety Outputs	Auxiliary output, 0.5 A max.
Output Voltage, Min.	(Uv) - 2V
Switching Current @ Voltage, Min.	500 mA @ 24V DC
Operating Characteristics	
Response Time	14 mm; 160 mm...1440 mm 20 ms, 1600 mm and 1760 mm, 25 ms. 30 mm; 20 ms. Add 10 ms when beam coding activated.
Status Indicators	ON State, OFF State, Blanking, Alignment, Interlock
Protected Height [mm (in.)]	See Product Selection tables.
Resolution [mm (in.)]	14 (0.55) or 30 (1.18)
Scanning Range/Resolution	0.3...7 m / 14 mm (0.98...22.9 ft / 0.55 in.) 0.3...16 m / 30 mm (0.98...52 ft / 1.18 in.)
Synchronization	Optical, first beam adjacent to LEDs.
Wavelength	870 nm
Environmental	
Enclosure Type Rating	IP65
Relative Humidity	15...95% (noncondensing)
Operating Temperature [C (F)]	-10...55° (14...131°)
Vibration	IEC60068-2-6: Frequency 10...55 Hz; Amplitude: 0.35 mm (0.01 in.)
Shock	IEC60068-2-29: Acceleration 10 g, pulse duration 16 ms 10...55 Hz
Physical Characteristics	
Mounting	End-cap brackets supplied
Weight	Varies by protective height
Housing Cross Section	40 mm x 50 mm (1.57 in. x 1.96 in.)
Connection Type	Transmitter: 4-pin M12 micro QD; Receiver: 8-pin M12 micro QD
Cable Length	30 m (100 ft) max.

Presence Sensing Safety Devices
POC Type 4 Safety Light Curtains
 GuardShield

Product Selection

Standard System

The Allen-Bradley Guardmaster GuardShield safety light curtains are ordered as pairs—transmitter and receiver—and shipped under one cat. no. After selecting the appropriate light curtain pair, ensure that required interfaces and accessories are ordered.

Protected Height [mm (in.)]	Resolution [mm (in.)]	Number of Beams	Cat. No.	Protected Height [mm (in.)]	Resolution [mm (in.)]	Number of Beams	Cat. No.
160 (6.3)	14 (0.55)	16	440L-P4J0160YD	160 (6.3)	30 (1.18)	8	440L-P4K0160YD
320 (12.6)	14 (0.55)	32	440L-P4J0320YD	320 (12.6)	30 (1.18)	16	440L-P4K0320YD
480 (18.9)	14 (0.55)	48	440L-P4J0480YD	480 (18.9)	30 (1.18)	24	440L-P4K0480YD
640 (25.2)	14 (0.55)	64	440L-P4J0640YD	640 (25.2)	30 (1.18)	32	440L-P4K0640YD
800 (31.5)	14 (0.55)	80	440L-P4J0800YD	800 (31.5)	30 (1.18)	40	440L-P4K0800YD
960 (37.8)	14 (0.55)	96	440L-P4J0960YD	960 (37.8)	30 (1.18)	48	440L-P4K0960YD
1120 (44.1)	14 (0.55)	112	440L-P4J1120YD	1120 (44.1)	30 (1.18)	56	440L-P4K1120YD
1280 (50.4)	14 (0.55)	128	440L-P4J1280YD	1280 (50.4)	30 (1.18)	64	440L-P4K1280YD
1440 (56.7)	14 (0.55)	144	440L-P4J1440YD	1440 (56.7)	30 (1.18)	72	440L-P4K1440YD
1600 (63.0)	14 (0.55)	160	440L-P4J1600YD	1600 (63.0)	30 (1.18)	80	440L-P4K1600YD
1760 (69.1)	14 (0.55)	176	440L-P4J1760YD	1760 (69.1)	30 (1.18)	88	440L-P4K1760YD

Note: The GuardShield transmitter requires a 4-pin cable and the receiver requires an 8-pin cable.

Note: To select just a transmitter or receiver, replace the "P" in the above cat. nos. with a "T" for transmitter and an "R" for receiver.

Remote Teach System

The Allen-Bradley Guardmaster GuardShield remote teach system is ordered as a system. The system consists of a standard GuardShield transmitter in either 14 mm or 30 mm resolutions with mounting hardware, a GuardShield receiver with a 10 inch Y-connector cable, a metal key switch box, and a 4-pin 2 meter patchcord which connects between the key switch box and the Y-connector.

Protected Height [mm (in.)]	Resolution [mm (in.)]	Number of Beams	Cat. No.	Protected Height [mm (in.)]	Resolution [mm (in.)]	Number of Beams	Cat. No.
160 (6.3)	14 (0.55)	16	440L-S4J0160YR	160 (6.3)	30 (1.18)	8	440L-S4K0160YR
320 (12.6)	14 (0.55)	32	440L-S4J0320YR	320 (12.6)	30 (1.18)	16	440L-S4K0320YR
480 (18.9)	14 (0.55)	48	440L-S4J0480YR	480 (18.9)	30 (1.18)	24	440L-S4K0480YR
640 (25.2)	14 (0.55)	64	440L-S4J0640YR	640 (25.2)	30 (1.18)	32	440L-S4K0640YR
800 (31.5)	14 (0.55)	80	440L-S4J0800YR	800 (31.5)	30 (1.18)	40	440L-S4K0800YR
960 (37.8)	14 (0.55)	96	440L-S4J0960YR	960 (37.8)	30 (1.18)	48	440L-S4K0960YR
1120 (44.1)	14 (0.55)	112	440L-S4J1120YR	1120 (44.1)	30 (1.18)	56	440L-S4K1120YR
1280 (50.4)	14 (0.55)	128	440L-S4J1280YR	1280 (50.4)	30 (1.18)	64	440L-S4K1280YR
1440 (56.7)	14 (0.55)	144	440L-S4J1440YR	1440 (56.7)	30 (1.18)	72	440L-S4K1440YR
1600 (63.0)	14 (0.55)	160	440L-S4J1600YR	1600 (63.0)	30 (1.18)	80	440L-S4K1600YR
1760 (69.1)	14 (0.55)	176	440L-S4J1760YR	1760 (69.1)	30 (1.18)	88	440L-S4K1760YR
Remote Teach Keyswitch Box Assembly*			440L-M8600	DC Micro Style Quick-Disconnect Patchcord, 4-Pin*			889D-F4ACDM-2

Note: The GuardShield transmitter requires a 4-pin cable and the receiver requires an 8-pin cable.

Note: The GuardShield remote teach system light curtains can be ordered as pairs by replacing the "S" in the cat. no. a with "P."

* Included with each system cat. no.; can be ordered as a replacement part.

Cascadable Standard System

Protected Height [mm (in.)]	Resolution [mm (in.)]	Number of Beams	Cat. No.	Protected Height [mm (in.)]	Resolution [mm (in.)]	Number of Beams	Cat. No.
320 (12.6)	14 (0.55)	32	440L-C4J0320YD	320 (12.6)	30 (1.18)	16	440L-C4K0320YD
480 (18.9)	14 (0.55)	48	440L-C4J0480YD	480 (18.9)	30 (1.18)	24	440L-C4K0480YD
640 (25.2)	14 (0.55)	64	440L-C4J0640YD	640 (25.2)	30 (1.18)	32	440L-C4K0640YD
800 (31.5)	14 (0.55)	80	440L-C4J0800YD	800 (31.5)	30 (1.18)	40	440L-C4K0800YD
960 (37.8)	14 (0.55)	96	440L-C4J0960YD	960 (37.8)	30 (1.18)	48	440L-C4K0960YD
1120 (44.1)	14 (0.55)	112	440L-C4J1120YD	1120 (44.1)	30 (1.18)	56	440L-C4K1120YD
1280 (50.4)	14 (0.55)	128	440L-C4J1280YD	1280 (50.4)	30 (1.18)	64	440L-C4K1280YD
1440 (56.7)	14 (0.55)	144	440L-C4J1440YD	1440 (56.7)	30 (1.18)	72	440L-C4K1440YD
1660 (63.0)	14 (0.55)	160	440L-C4J1600YD	1600 (63.0)	30 (1.18)	80	440L-C4K1600YD
1760 (69.3)	14 (0.55)	176	440L-C4J1760YD	1760 (69.3)	30 (1.18)	88	440L-C4K1760YD

Note: Cascadable systems are sold in pairs represented by the "C" in the cat. no. To order the cascadable transmitter or receiver, replace the "C" with a "G" for the transmitter or "F" for the receiver.

GuardShield with Integrated Laser Alignment

Protected Height [mm (in.)]	Resolution [mm (in.)]	Number of Beams	Cat. No.	Protected Height [mm (in.)]	Resolution [mm (in.)]	Number of Beams	Cat. No.
320 (12.6)	14 (0.55)	32	440L-P4JL0320YD	320 (12.6)	30 (1.18)	16	440L-P4KL0320YD
480 (18.9)	14 (0.55)	48	440L-P4JL0480YD	480 (18.9)	30 (1.18)	24	440L-P4KL0480YD
640 (25.2)	14 (0.55)	64	440L-P4JL0640YD	640 (25.2)	30 (1.18)	32	440L-P4KL0640YD
800 (31.5)	14 (0.55)	80	440L-P4JL0800YD	800 (31.5)	30 (1.18)	40	440L-P4KL0800YD
960 (37.8)	14 (0.55)	96	440L-P4JL0960YD	960 (37.8)	30 (1.18)	48	440L-P4KL0960YD
1120 (44.1)	14 (0.55)	112	440L-P4JL1120YD	1120 (44.1)	30 (1.18)	56	440L-P4KL1120YD
1280 (50.4)	14 (0.55)	128	440L-P4JL1280YD	1280 (50.4)	30 (1.18)	64	440L-P4KL1280YD
1440 (56.7)	14 (0.55)	144	440L-P4JL1440YD	1440 (56.7)	30 (1.18)	72	440L-P4KL1440YD
1600 (63.0)	14 (0.55)	160	440L-P4JL1600YD	1600 (63.0)	30 (1.18)	80	440L-P4KL1600YD

Note: GuardShields are sold in pairs. To select a transmitter or receiver, replace the "P" in the cat. no. with a "T" for transmitter and an "R" for receiver.

Cascadable GuardShield with Integrated Laser Alignment

Protected Height [mm (in.)]	Resolution [mm (in.)]	Number of Beams	Cat. No.	Protected Height [mm (in.)]	Resolution [mm (in.)]	Number of Beams	Cat. No.
320 (12.6)	14 (0.55)	32	440L-C4JL0320YD	320 (12.6)	30 (1.18)	16	440L-C4KL0320YD
480 (18.9)	14 (0.55)	48	440L-C4JL0480YD	480 (18.9)	30 (1.18)	24	440L-C4KL0480YD
640 (25.2)	14 (0.55)	64	440L-C4JL0640YD	640 (25.2)	30 (1.18)	32	440L-C4KL0640YD
800 (31.5)	14 (0.55)	80	440L-C4JL0800YD	800 (31.5)	30 (1.18)	40	440L-C4KL0800YD
960 (37.8)	14 (0.55)	96	440L-C4JL0960YD	960 (37.8)	30 (1.18)	48	440L-C4KL0960YD
1120 (44.1)	14 (0.55)	112	440L-C4JL1120YD	1120 (44.1)	30 (1.18)	56	440L-C4KL1120YD
1280 (50.4)	14 (0.55)	128	440L-C4JL1280YD	1280 (50.4)	30 (1.18)	64	440L-C4KL1280YD
1440 (56.7)	14 (0.55)	144	440L-C4JL1440YD	1440 (56.7)	30 (1.18)	72	440L-C4KL1440YD
1600 (63.0)	14 (0.55)	160	440L-C4JL1600YD	1600 (63.0)	30 (1.18)	80	440L-C4KL1600YD

Note: Cascadable GuardShields are sold in pairs. To select a transmitter or receiver, replace the "C" with a "G" for cascadable transmitter and an "F" for a cascadable receiver.

2-Opto-electronics

Presence Sensing Safety Devices
POC Type 4 Safety Light Curtains
 GuardShield

GuardShield with Integrated Laser Alignment and ArmorBlock Guard I/O Connectivity

Protected Height [mm (in.)]	Resolution [mm (in.)]	Number of Beams	Cat. No.	Protected Height [mm (in.)]	Resolution [mm (in.)]	Number of Beams	Cat. No.
320 (12.6)	14 (0.55)	32	440L-P4JL0320YA	320 (12.6)	30 (1.18)	16	440L-P4KL0320YA
480 (18.9)	14 (0.55)	48	440L-P4JL0480YA	480 (18.9)	30 (1.18)	24	440L-P4KL0480YA
640 (25.2)	14 (0.55)	64	440L-P4JL0640YA	640 (25.2)	30 (1.18)	32	440L-P4KL0640YA
800 (31.5)	14 (0.55)	80	440L-P4JL0800YA	800 (31.5)	30 (1.18)	40	440L-P4KL0800YA
960 (37.8)	14 (0.55)	96	440L-P4JL0960YA	960 (37.8)	30 (1.18)	48	440L-P4KL0960YA
1120 (44.1)	14 (0.55)	112	440L-P4JL1120YA	1120 (44.1)	30 (1.18)	56	440L-P4KL1120YA
1280 (50.4)	14 (0.55)	128	440L-P4JL1280YA	1280 (50.4)	30 (1.18)	64	440L-P4KL1280YA
1440 (56.7)	14 (0.55)	144	440L-P4JL1440YA	1440 (56.7)	30 (1.18)	72	440L-P4KL1440YA
1600 (63.0)	14 (0.55)	160	440L-P4JL1600YA	1600 (63.0)	30 (1.18)	80	440L-P4KL1600YA

Note: GuardShields are sold in pairs. To select a transmitter or receiver, replace the "P" in the cat. no. with an "R" for a receiver. The GuardShield standard transmitter is used in the pair. To order a transmitter, replace the "P" with a "T" and the "A" with a "D."

Cascadable GuardShield with Integrated Laser Alignment and ArmorBlock Guard I/O Connectivity

Protected Height [mm (in.)]	Resolution [mm (in.)]	Number of Beams	Cat. No.	Protected Height [mm (in.)]	Resolution [mm (in.)]	Number of Beams	Cat. No.
320 (12.6)	14 (0.55)	32	440L-C4JL0320YA	320 (12.6)	30 (1.18)	16	440L-C4KL0320YA
480 (18.9)	14 (0.55)	48	440L-C4JL0480YA	480 (18.9)	30 (1.18)	24	440L-C4KL0480YA
640 (25.2)	14 (0.55)	64	440L-C4JL0640YA	640 (25.2)	30 (1.18)	32	440L-C4KL0640YA
800 (31.5)	14 (0.55)	80	440L-C4JL0800YA	800 (31.5)	30 (1.18)	40	440L-C4KL0800YA
960 (37.8)	14 (0.55)	96	440L-C4JL0960YA	960 (37.8)	30 (1.18)	48	440L-C4KL0960YA
1120 (44.1)	14 (0.55)	112	440L-C4JL1120YA	1120 (44.1)	30 (1.18)	56	440L-C4KL1120YA
1280 (50.4)	14 (0.55)	128	440L-C4JL1280YA	1280 (50.4)	30 (1.18)	64	440L-C4KL1280YA
1440 (56.7)	14 (0.55)	144	440L-C4JL1440YA	1440 (56.7)	30 (1.18)	72	440L-C4KL1440YA
1600 (63.0)	14 (0.55)	160	440L-C4JL1600YA	1600 (63.0)	30 (1.18)	80	440L-C4KL1600YA

Note: Cascadable GuardShields are sold in pairs. To select a transmitter or receiver replace the "C" with an "F" for a cascadable receiver. The cascadable GuardShield standard transmitter is used in these pairs. To order a cascadable transmitter, replace the "C" with a "G" and the "A" with a "D" to specify the appropriate transmitter cat. no.

Recommended Logic Interfaces

Description	Safety Outputs	Auxiliary Outputs	Terminals	Reset Type	Power Supply	Cat. Page No.	Cat. No.
Single-Function Safety Relays for 2 N.C. Contact Switch							
MSR127RP	3 N.O.	1 N.C.	Removable (Screw)	Monitored Manual	24V AC/DC	5-26	440R-N23135
MSR127TP	3 N.O.	1 N.C.	Removable (Screw)	Auto./Manual	24V AC/DC	5-26	440R-N23132
MSR126	2 N.O.	None	Fixed	Auto./Manual	24V AC/DC	5-24	440R-N23117
Modular Safety Relays							
MSR210P Base 2 N.C. only	2 N.O.	1 N.C. and 2 PNP Solid State	Removable	Auto./Manual or Monitored Manual	24V DC from the base unit	5-82	440R-H23176
MSR211	2 N.O.	1 N.C.	Removable	Auto./Manual or Monitored Manual	24V DC from the base unit	5-84	440R-H23177
MSR310P Base	MSR300 Series Output Modules	3 PNP Solid State	Removable	Auto./Manual Monitored Manual	24V DC	5-102	440R-W23219
MSR320P Input Module	—	2 PNP Solid State	Removable	—	24V DC from the base unit	5-106	440R-W23218
Muting Modules							
MSR22LM	2 N.O.	1 N.C.	Removable	Auto./Manual	24V DC	5-48	440R-P23071
MSR42 (requires optical interface to configure 445L-AF6150)	2 PNP	2 PNP, configurable	Removable	Auto./manual or manual monitored	24V DC	5-52	440R-P226AGS-NNR

Standard and Remote Teach Cordsets—Two Required (one for transmitter and one for receiver)

Female Connector (Sensor End)		Cable			Cat. No.
Face View of Female	Connector Style	Pin/Wire Color	Wire Rating	Length [m (ft)]	
Transmitter					
	Straight Female	1 Brown 2 White 3 Blue 4 Black	22 AWG 300V 4 A	2 (6.56)	889D-F4AC-2
				5 (16.4)	889D-F4AC-5
				10 (32.8)	889D-F4AC-10
				15 (49.2)	889D-F4AC-15
				20 (65.6)	889D-F4AC-20
				30 (98.4)	889D-F4AC-30
Receiver					
	Straight Female	1 White 2 Brown 3 Green 4 Yellow 5 Grey 6 Pink 7 Blue 8 Red	24 AWG 30V AC/36V DC 1.5 A	2 (6.56)	889D-F8AB-2
				5 (16.4)	889D-F8AB-5
				10 (32.8)	889D-F8AB-10
				15 (49.2)	889D-F8AB-15
				20 (65.6)	889D-F8AB-20
				30 (98.4)	889D-F8AB-30

Cascadable System Patchcords—to connect cascadable GuardShield system

The GuardShield transmitter host patchcord has 4-pin DC micro over-molded quick-disconnect connectors offered in lengths of 1/3 m, 1 m, and 2 m. The GuardShield receiver host patchcord has 8-pin DC micro over-molded quick-disconnect connectors offered in lengths of 1/3 m, 1 m, and 2 m.

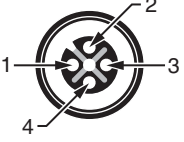
Face View of Female	Description	Cat. No.
Transmitter Patchcord		
	4-pin M12 patchcord, 0.3 m (12 in.)	889D-F4ACDM-0M3
	4-pin M12 patchcord, 1 m (39.37 in.)	889D-F4ACDM-1
	4-pin M12 patchcord, 2 m (78.74 in.)	889D-F4ACDM-2

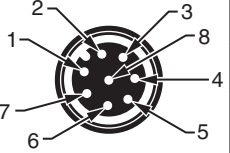
Face View of Female	Description	Cat. No.
Receiver Patchcord		
	8-pin M12 patchcord, 0.3 m (12 in.)	889D-F8ABDM-0M3
	8-pin M12 patchcord, 1 m (39.37 in.)	889D-F8ABDM-1
	8-pin M12 patchcord, 2 m (78.74 in.)	889D-F8ABDM-2

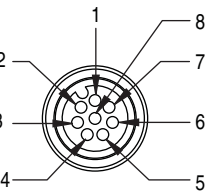
Face View of Female	Description	Cat. No.
Receiver Termination Plug		
 	Termination plug 8-pin M12 quick disconnect Required for connection to top connector of cascadable receiver if cascade light curtain is used as a standalone system or as the last segment pair in a cascaded system.	898D-81CU-DM

Note: A termination plug is not necessary for the cascadable transmitter.

Cordsets Approximate Dimensions [mm (in.)]

Dimensions are not intended to be used for installation purposes.

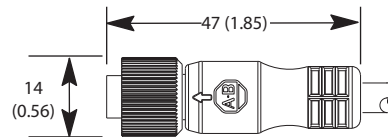

Straight Female M12 Quick Disconnect

ArmorBlock Guard I/O

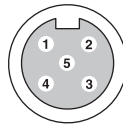
Top View	Color	No. of Pins	Signal
			Receiver
	Brown	1	+24V
	White	2	OSSD 2
	Blue	3	0V
	Black	4	OSSD 1
	Grey	5	NC

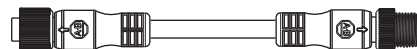

Interconnecting Patchcords—ArmorBlock I/O Connection

Cat. No.	Description
889D-F5ACDM-0M3	Five-pin M12 patchcord, 0.3 m (12 in.)
889D-F5ACDM-1	Five-pin M12 patchcord, 1 m (39.37 in.)
889D-F5ACDM-2	Five-pin M12 patchcord, 2 m (78.74 in.)
889D-F5ACDM-5	Five-pin M12 patchcord, 5 m (196.85 in.)
889D-F5ACDM-10	Five-pin M12 patchcord, 10 m (393.7 in.)

Note: The GuardShield pairs with ArmorBlock Guard I/O Connectivity have a 5-pin M12 quick-disconnect connector on the receiver wired to allow connection to the ArmorBlock 5-pin connector. The transmitter in that GuardShield pair is a standard GuardShield transmitter with integrated laser alignment system offered with a 4-pin M12 quick-disconnect connector. It is possible to connect either a standard 4-pin M12 cordset or the 5-pin M12 quick-disconnect connector cordset or patchcord to this transmitter.

2-Opto-electronics





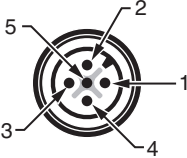







Presence Sensing Safety Devices
POC Type 4 Safety Light Curtains
 GuardShield

Termination Connector for Cascadable GuardShield Receiver (if it's a standalone pair) with ArmorBlock Guard I/O Connectivity

Face View of Female	Description	Cat. No.
	5-pin M12 Termination Adaptor	898D-418U-DM

Note: The cascadable GuardShield with ArmorBlock Guard I/O connectivity can be used as a standalone pair if the top connector on the receiver has a termination adaptor connected. The cascadable transmitter does not require a termination adaptor.

Optional Accessories

	Description	Cat. No.
	Steel L-shaped end cap mounting bracket (4 per package) Note: 4 brackets supplied with each GuardShield pair.	440L-AF6101
	Aluminum middle mounting bracket for vibratory applications	440L-AF6108
	Power supply: Output—24V DC, 3 Amps, 72 W	1606-XLP72E
	Laser alignment tool	440L-ALAT
	GuardShield laser alignment tool bracket	440L-AF6109
	Mounting stand	440L-AMSTD
	Vertical shock mount kit	440L-AF6120
	Horizontal shock mount kit	440L-AF6121
	Middle vertical mount kit	440L-AF6122
	Middle horizontal mount kit	440L-AF6123
	GuardShield weld shield (cat. no. is for a pair of light curtains)	440L-AGWS0160
		440L-AGWS0320
		440L-AGWS0480
		440L-AGWS0640
		440L-AGWS0800
		440L-AGWS0960
		440L-AGWS1120
		440L-AGWS1280
		440L-AGWS1440
		440L-AGWS1600
	GuardShield Washdown Enclosure Kit Note: Only for use with standard GuardShield light curtain.	440L-AGWS1760
		440L-AGST320
		440L-AGST480
		440L-AGST640
		440L-AGST800
	8-pin M12 Receiver Termination Plug (Required for top receiver connector if a cascaded pair is used as a standalone or if it is the last pair in a cascaded system.)	440L-AGST960
		898D-81CU-DM

2-Opto-electronics

Presence Sensing Safety Devices
POC Type 4 Safety Light Curtains
 GuardShield

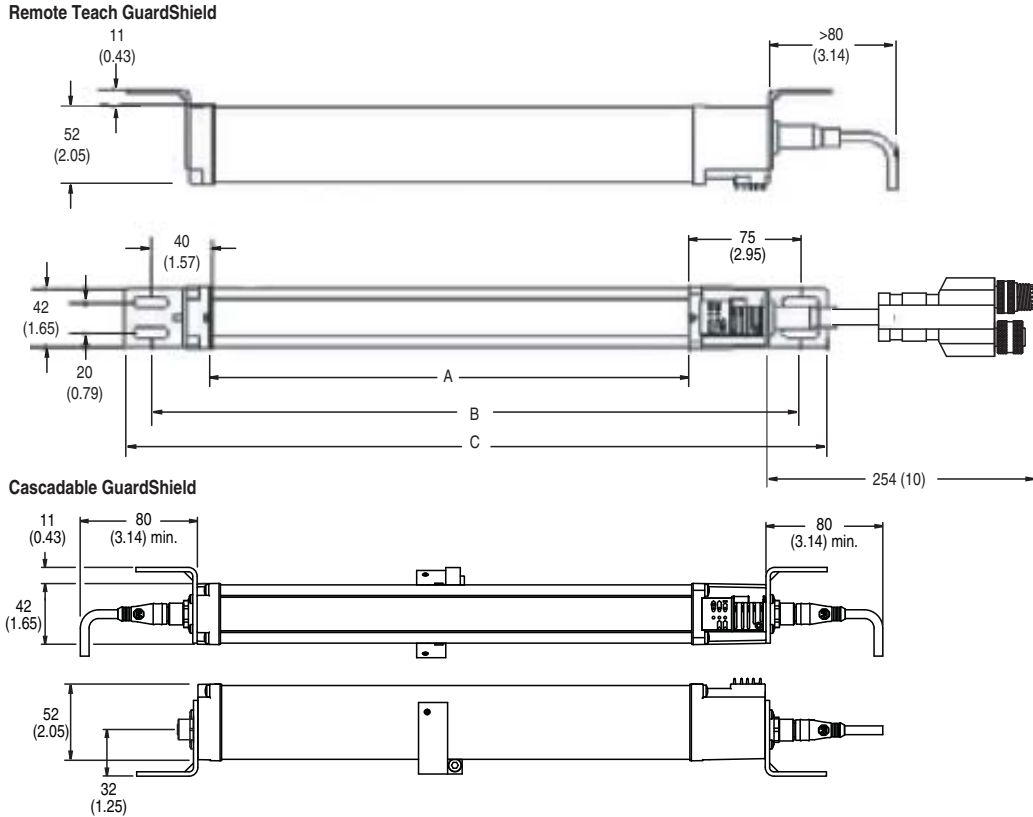

Note: Middle mounting bracket should be used in vibration applications on GuardShield light curtain protective heights of 1120 mm and larger.

Type	A Protective Height [mm]	B Mounting Value [mm]	C Total Length [mm]
440L-4‡0160YD	160 ±0.5§	276	312 ±1.5
440L-4‡0320YD	320 ±0.5	436	472 ±1.5
440L-4‡0480YD	480 ±0.5	596	632 ±1.5
440L-4‡0640YD	640 ±0.5	756	792 ±1.5
440L-4‡0800YD	800 ±0.6	916	952 ±1.5
440L-4‡0960YD	960 ±0.6	1076	1112 ±1.5
440L-4‡1120YD	1120 ±0.6	1236	1272 ±1.8
440L-4‡1280YD	1280 ±0.7	1396	1432 ±1.8
440L-4‡1440YD	1440 ±0.7	1556	1592 ±1.8
440L-4‡1600YD	1600 ±0.8	1716	1752 ±2.0
440L-4‡1760YD	1760 ±0.8	1876	1912 ±2.0

* P = Pair, T = Transmitter, R = Receiver
 † P = Pair, T = Transmitter, R = Receiver, C = Host Pair, G = Host Transmitter, F = Host Receiver
 ‡ J = 14 mm resolution or K = 30 mm resolution
 § 160 mm is not available for cascading GuardShield light curtains.