

### Applications

- Boxes are installed in ceilings or walls for lighting fixtures, switches or receptacles
- Square boxes are used where multiple conductor runs are split into two or more directions to bring power to a number of electrical devices
- Drawn boxes are ideal for exposed work applications

### Product Features

- Combination screw heads provide for faster installation
- Thru-the-wall box is designed for shallow wall applications and allows for attachment of wall plate to both faces of box
- TKO® knockouts offer greater flexibility with RACO® patented combination 1/2" and 3/4" knockout
- TKO® knockouts allow for design and installation flexibility

### Compliances

-  - File E195978

All RACO® single gang, two gang, 4" square, and single gang gangable U.L. listed steel boxes are acceptable for use in 2-hour fire rated walls. For additional information, consult U.L. "Fire Resistance Directory" or the U.L. website at [www.ul.com](http://www.ul.com)

**250V** Per U.L. 514-A, suitable for use without a bonding jumper in circuits above or below 250 volts

### 4" SQUARE BOXES

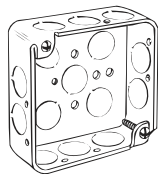
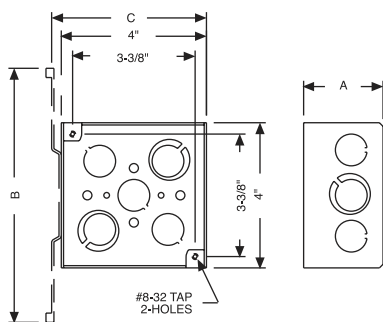

185

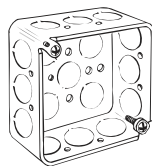

190, 8190

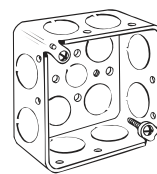

191, 8191

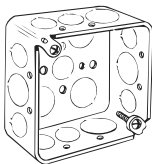

192, 8192

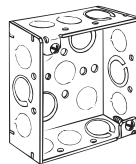

189, 8189

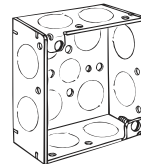

181

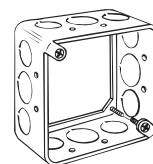

204

### ORDERING INFORMATION - DIMENSIONS

4" SQUARE - 1-1/4" DEEP - DRAWN WITH CONDUIT KO'S - 18.0 CUBIC INCHES					
CATALOG NUMBER	DESCRIPTION BRACKET & SETBACK	KNOCKOUTS		STD. PKG.	UPC BAR CODE
		SIDES COND.	BOTTOM COND.		
185	—	10-1/2"	5-1/2"	50	

4" SQUARE - 1-1/2" DEEP - DRAWN WITH CONDUIT KO'S - 21.0 CUBIC INCHES					
CATALOG NUMBER	DESCRIPTION BRACKET & SETBACK	KNOCKOUTS		STD. PKG.	UPC BAR CODE
		SIDES COND.	BOTTOM COND.		
190	—	12-1/2"	5-1/2"	50	—
8190	—	12-1/2"	5-1/2"	50	
191	—	8-3/4"	1-1/2", 4-3/4"	50	—
8191	—	—	—	25	
192	—	8-1/2", 4-3/4"	3-1/2", 2-3/4"	50	—
8192	—	—	—	50	

4" SQUARE - 1-1/2" DEEP - WELDED WITH CONDUIT KO'S - 21.0 CUBIC INCHES					
CATALOG NUMBER	DESCRIPTION BRACKET & SETBACK	KNOCKOUTS		STD. PKG.	UPC BAR CODE
		SIDES COND.	BOTTOM COND.		
<b>250V</b> 189	—	8-1/2", 4-TKO®	3-1/2", 2-TKO®	50	—
<b>250V</b> 8189	—	—	—	50	
181	—	8-3/4"	1-1/2", 4-3/4"	50	—

4" SQUARE - THRU-THE-WALL BOX - 1-1/2" DEEP - DRAWN WITH CONDUIT KO'S - 22.5 CUBIC INCHES						
CATALOG NUMBER	DESCRIPTION BRACKET & SETBACK	KNOCKOUTS		CU. IN.	STD. PKG.	UPC BAR CODE
		SIDES COND.	BOTTOM COND.			
204	—	8-1/2", 4-3/4"	—	21	50	—

DIMENSIONS			
CATALOG NUMBER	A	B	C
185	1-1/2"	—	—
190, 8190	1-1/2"	—	—
191, 8191	1-1/2"	—	—
192, 8192	1-1/2"	—	—
189, 8189	1-1/2"	—	—
181	1-1/2"	—	—
204	1-1/2"	—	—