

FEATURES & SPECIFICATIONS

INTENDED USE

Intended for low to medium mounting heights where dust, dirt, humidity, moisture, or corrosive elements are present. Ideal for canopies, dock areas, wastewater treatment, refrigerated areas, food processing and other non-hazardous environments.

CONSTRUCTION

Housing formed from impact resistant, UV stabilized, fiberglass reinforced polyester with cold-rolled steel enclosed wireway. Poured in gasketing provides a seal between housing and diffuser. Captive, corrosion-resistant cam-action latches secure the diffuser; six on 4' units, and ten on 8' units. Stainless steel latches available.

FINISH

Painted parts pretreated with a five-stage iron-phosphate process to ensure superior paint adhesion and corrosion resistance, then finished with a high-gloss, baked white enamel.

OPTICAL SYSTEM

Acrylic diffuser with a stippled interior surface to spread lamp image. High-impact diffuser optional.

ELECTRICAL SYSTEM

Thermally protected, resetting, Class P, HPF, non-PCB, UL Listed and CSA Certified ballast is standard. Sound rating depends on lamp/ballast combination.

AWM, TFN, THHN wire throughout, rated for required temperatures.

INSTALLATION

For unit or row installations, surface (ceiling or wall) or suspended mounting.

LISTING

120V, 277V and MVOLT are UL Listed and CSA Certified (standard). 347V is CSA Certified (see Options). NOM Certified (see Options). Suitable for wet (DMW) or damp (DM) locations. Compliance to FDA/USDA requirements and/or NSF splash-zone certification (DMW).

WARRANTY

Guaranteed for one year against mechanical defects in manufacture.

Catalog Number	
Notes	Type

Enclosed and Gasketed Industrial

DM/DMW

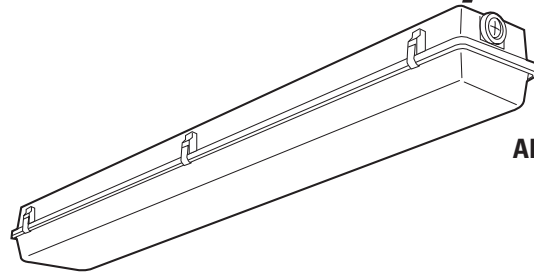

**PROGRAMMED
AND RAPID START**
4' or 8' length
1, 2 or 3 lamps

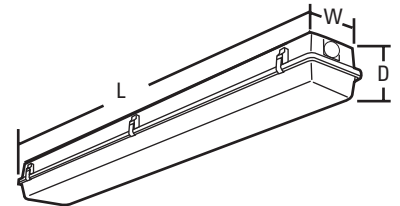

Specifications

Length:	50" (1270)
	98" (2489)
Width:	8-1/8" (206)
Fixture Depth:	5-5/8" (143)

All dimensions are inches (millimeters). Specifications subject to change without notice.

ORDERING INFORMATION

For shortest lead times, configure product using **standard options (shown in bold)**.

Example: DMW 2 32 MVOLT GEB10IS

Series	Number of lamps	Lamp type	Diffuser	Voltage	Options
DM Damp location	1	32 32W T8 (48")	(blank) Acrylic(15% DR)	120	ELDW Emergency battery pack (nominal 300 lumens)
DMW Wet location	2	54 54W T5HO (48") ²	AR High-impact acrylic (50% DR)	277	EL5DW Emergency battery pack (nominal 500 lumens)
	3'		DP Deep acrylic ³	347	EL6DW Emergency battery pack (nominal 600 lumens)
	Not included		ARDP Deep high-impact acrylic ³	MVOLT⁴	EL14DW Emergency battery pack (nominal 1400 lumens)
				Others available	GEB Electronic ballasts, ≤20% THD
					GEB10IS Electronic ballasts, ≤10% THD, Instant Start¹
					GEB10RS Electronic ballasts, ≤10% THD, Rapid Start⁶
					GLR Internal fast-blow fuse
					GMF Internal slow-blow fuse
					RIF1 Radio interference filter, 1 per fixture
					STSL Stainless steel latches
					WLF Wet location fittings (1 pair, installed in fixture top; DM still will be damp)
					CSA CSA Certified (Only required for 347V)
					NOM NOM Certified
					BDP In-fixture ballast disconnect plug

NOTES:

- 32W T8 lamps only.
- Must use ACNS90 ballast.
- Deep lens is standard on 8' fixtures.
- MVOLT available with GEB10IS only.
- Available with only 32 watt lamp types.

Accessories

Order as separate catalog numbers.

- BCD Bracket for hanger chain mounting. Two per package.
- HC36 Chain hangers (1 pair, 36" long). Requires BCD.
- WLF Wet location fittings (1 pair, not installed).

DM/DMW Rapid Start

MOUNTING DATA

For unit or row installation, surface (ceiling or wall) or suspended mounting.

DM/DMW — Drill holes through housing and channel at appropriate locations.

DMW — Includes gasketed wet location fittings on ends for power feeding/mounting. Fitting is threaded for 1/2" rigid conduit (optional WLF for top mounting). Attach to surface using fasteners and sealing washers (by others) appropriate to ceiling materials.

Unit installation — Minimum of two hangers required.

Row installation — Minimum of two hangers required.
Recommend 1/2" nipple with union (by others) for DMW.

See ACCESSORIES below for hanging devices.

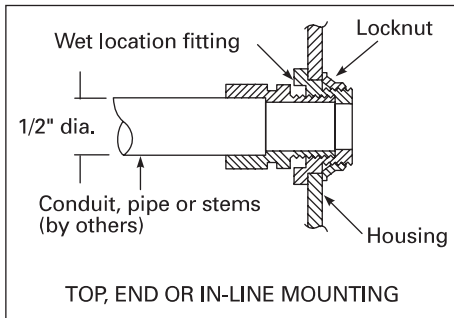

DIMENSIONS

Inches (millimeters). Subject to change without notice.

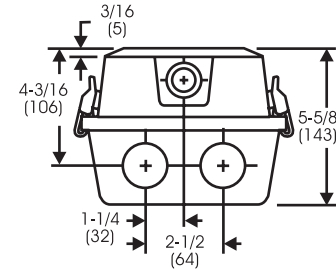
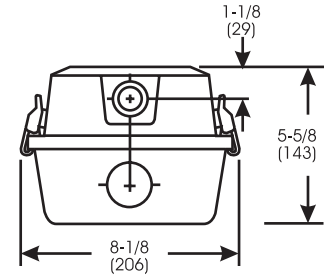

A = 11/16 (17) Dia.
B = 1-1/8 (29) Dia.
Recommended mounting locations
(field drilling required)
*8' fixtures are 5-5/8" deep
4' fixtures are 4-5/8" deep

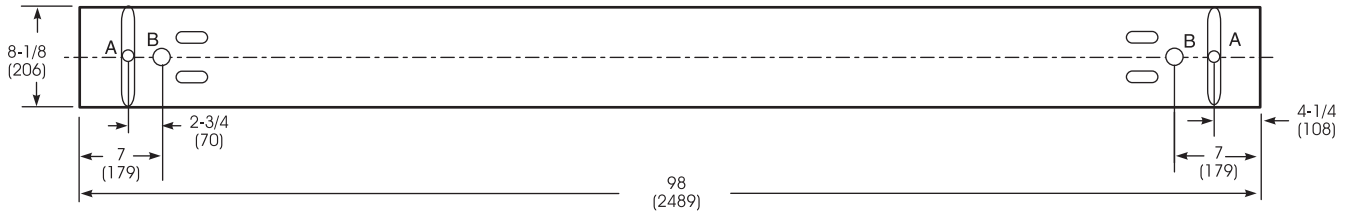
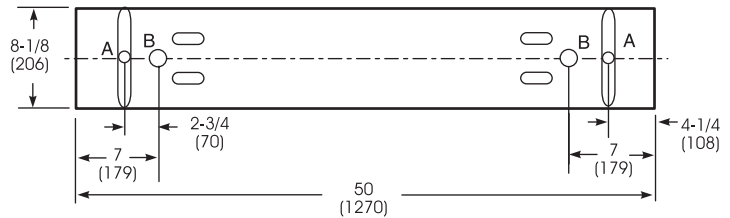

PHOTOMETRICS

Calculated using the zonal cavity method in accordance with IESNA LM41 procedure. Floor reflectances are 20%. Lamp configurations shown are typical. Full photometric data on these and other configurations available upon request.

DM/DMW 232

Report LTL 5583

S/MH (along) 1.3 (across) 1.6

Coefficient of Utilization

Ceiling	80%			70%			50%		
	70%	50%	30%	70%	50%	30%	50%	30%	10%
1	82	78	74	80	76	72	71	69	66
2	74	67	61	72	65	60	61	57	53
3	67	58	52	65	57	51	54	48	44
4	61	51	44	59	50	43	47	42	37
5	56	45	38	54	44	37	42	36	31
10	37	26	19	36	25	19	24	19	15

Zonal Lumens Summary

Zone	Lumens	%Lamp	%Fixture
0-30	884	15.2	19.5
0-40	1511	26.0	33.4
0-60	2883	49.7	63.7
0-90	4260	73.4	94.1
90-180	268	4.6	5.9
0-180	4528	78.1	100.0