

MAESTRO® Fan/Light

English

Quiet Fan Speed Control and Incandescent/Halogen Dimmer Single-Location System (MA-LFQHW)

Canopy Module

CM-L300FQ1: 120 V~ 60 Hz (300 W light / 1 A fan)

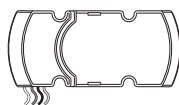

Wall Control

MA-LFQ35: 120 V~ 60 Hz 3.5 A (one CM-L300FQ1)

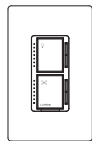

Warning: For use with one ceiling paddle fan and light only. Do not use with an exhaust fan or more than one fan.

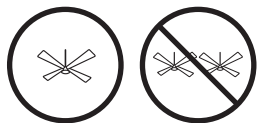

One ceiling fan only



No exhaust fans

Important Notes

Please read before installing.

- Caution:** To avoid overheating and possible damage to other equipment, do not use to control receptacles, fluorescent or neon lighting fixtures, transformer-supplied appliances, solid state fan motors, or exhaust fans. For exhaust fans use Lutron fully variable fan speed controls.
- Install in accordance with all national and local electrical codes.
- When no "grounding means" exist within the wallbox then the NEC® 2005, Article 404-9 allows a wall control without a grounding connection to be installed as a replacement, as long as a plastic, noncombustible wallplate is used. For this type of installation, cap or remove the green ground wire on the wall control and use an appropriate wallplate such as Lutron's *Claro*® series wallplates.
- The *Maestro*® dual fan/light control system consists of a Wall Control and a Canopy Module. Both must be installed correctly before attempting to control the fan/light fixture. Do not attempt to mix Lutron controls with those from other manufacturers, or mix Lutron controls not labeled for use together.
- This system is not compatible with fans having a control system built into the motor.
- Do not paint Wall Control or Canopy Module.
- Do not use where total lamp wattage is less than 40 W or greater than 300 W.
- Operate between 32 °F (0 °C) and 104 °F (40 °C) room temperature. For indoor use only.
- Wall Control may feel warm to the touch during normal operation.
- Recommended wallbox depth is 2.5" (64 mm) minimum.
- Clean Wall Control with a soft damp cloth only.** Do not use any chemical cleaners.
- This system cannot be used to change the direction of the fan. To change the fan direction, stop the fan, and then change the position of the switch located on the body of the fan.
- To maximize light bulb life, use bulbs recommended for fan or "rough service" use.
- Do not use pull chains to operate fan/light after installing this system.
- Canopy Module must be installed within a fan canopy enclosure.
- This device complies with Part 15 of the FCC Rules. Operation is subject to the following two conditions: (1) this device may not cause harmful interference, and (2) this device must accept any interference received, including interference that may cause undesired operation.

NOTE: This equipment has been tested and found to comply with the limits for a Class B digital device, pursuant to Part 15 of the FCC Rules. These limits are designed to provide reasonable protection against harmful interference in a residential installation. This equipment generates, uses and can radiate radio frequency energy and, if not installed and used in accordance with the instructions, may cause harmful interference to radio communications. However, there is no guarantee that interference will not occur in a particular installation. If this equipment does cause harmful interference to radio or television reception, which can be determined by turning the equipment off and on, the user is encouraged to try to correct the interference by one or more of the following measures:

- Reorient or relocate the receiving antenna.
- Increase the separation between the equipment and receiver.
- Connect the equipment into an outlet on a circuit different from that to which the receiver is connected.
- Consult the dealer or an experienced radio/TV technician for help.

Multigang Installations

When installing more than one control in the same wallbox, it may be necessary to remove all inner side sections prior to wiring (see below). Using pliers, bend side sections up and down until they break off. Repeat for each side section to be removed. **Note: Product does not require derating when side sections are removed.**

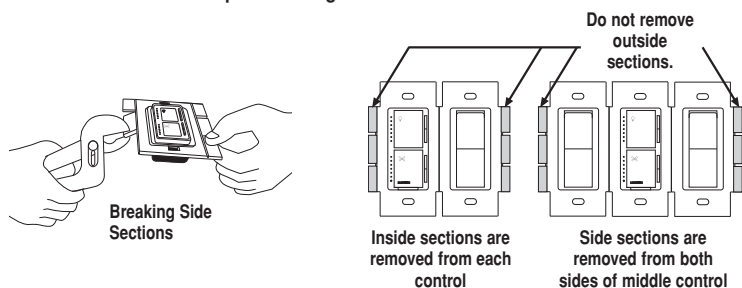

Technical Assistance

If you have questions concerning the installation or operation of this product, call the **Lutron Technical Support Center**. Please provide exact model number when calling.

U.S.A. and Canada (24 hrs/7days): +1-800-523-9466
Other countries 8am – 8pm ET: +1-610-282-3800

Fax +1-610-282-6311

<http://www.lutron.com>

Reference Wiring Diagram

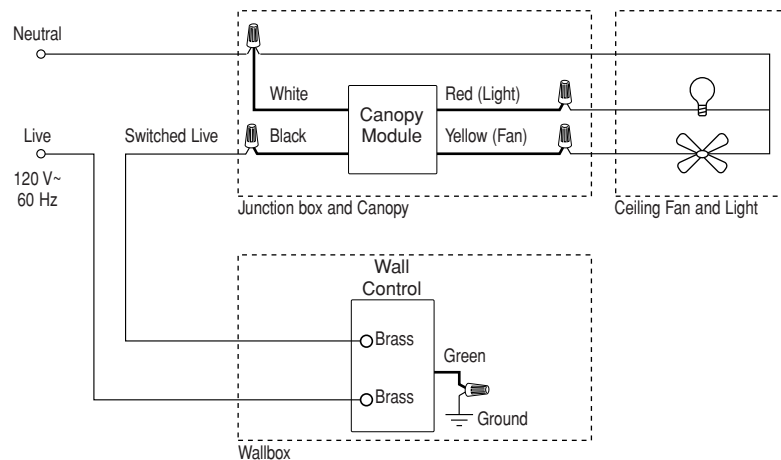

Operation

Light Level Tap Button

- **Tap once when lights are off** - Lights brighten smoothly to preset intensity.
- **Tap once when lights are on** - Lights dim smoothly to off.
- **Tap twice quickly** - Lights brighten rapidly to full intensity.
- **Press and hold when lights are on** - Activates delayed fade to off mode. As the tap button is held, the LEDs will begin to flash. The first flashing LED represents a 10 second fade to OFF. Each additional flashing LED represents an additional 10 seconds of delay before lights fade to OFF (up to 60 seconds of delay).

Fan Speed Tap Button

- **Tap once when fan is off** - Fan speed increases to preset level.
- **Tap once when fan is on** - Fan speed slows to off.
- **Tap twice quickly** - Fan speed increases to full speed.

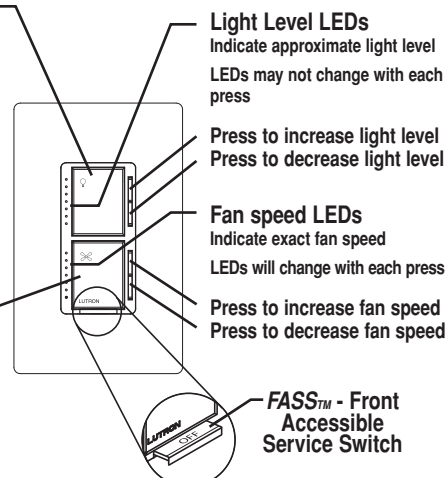

Light Level LEDs

Indicate approximate light level
LEDs may not change with each press

Press to increase light level
Press to decrease light level

Fan speed LEDs

Indicate exact fan speed
LEDs will change with each press

Press to increase fan speed
Press to decrease fan speed

FASS™ - Front Accessible Service Switch

IMPORTANT NOTICE:

To replace bulb, remove power by pulling the FASS switch out on the Wall Control.
For any procedure other than routine bulb replacement, power must be disconnected at the main electrical panel.

Troubleshooting

Symptom	Possible Cause
Light or fan does not turn ON or no LEDs turn ON.	<ul style="list-style-type: none"> • Front Accessible Service Switch (FASS) on Wall Control is pulled out to the OFF position. • Manual switch on fan is off (ex: pull chain). • Light bulb(s) burned out. • Breaker is OFF or tripped (or fuse blown). • Fan direction switch is between forward and reverse. • Wiring error, call Lutron Technical Support Center at +1-800-523-9466.
Upper LEDs on Wall Control cycle rapidly and bottom LED is ON.	<ul style="list-style-type: none"> • Unit is not activated properly. Activate system as described in Step 14. • Wiring error, call Lutron Technical Support Center at +1-800-523-9466.
Upper LEDs on Wall Control cycle rapidly and second lowest LED is ON.	<ul style="list-style-type: none"> • Communication error. Check wiring; if error continues, call Lutron Technical Support Center at +1-800-523-9466.
Fan vibrates or wobbles.	<ul style="list-style-type: none"> • Fan blades not properly balanced. See fan manufacturer's instructions.
Light dims in large steps and fan is noisy or does not spin at correct speed.	<ul style="list-style-type: none"> • Fan and light control wires on Canopy Module are reversed.
Light button controls fan and vice-versa.	<ul style="list-style-type: none"> • Fan and light control wires on Canopy Module are reversed.
Fan speeds too slow.	<ul style="list-style-type: none"> • Fan pull chain not set to high.
Wall Control LEDs respond as expected but fan and/or light does not respond properly.	<ul style="list-style-type: none"> • Fan and/or light pull chains not set to high/on. • Wiring error, call Lutron Technical Support Center at +1-800-523-9466.

Limited Warranty

(Valid only in U.S.A., Canada, Puerto Rico, and the Caribbean.)

Lutron will, at its option, repair or replace any unit that is defective in materials or manufacture within one year after purchase. For warranty service, return unit to place of purchase or mail to Lutron at 7200 Suter Rd., Coopersburg, PA 18036-1299, postage pre-paid.
THIS WARRANTY IS IN LIEU OF ALL OTHER EXPRESS WARRANTIES, AND THE IMPLIED WARRANTY OF MERCHANTABILITY IS LIMITED TO ONE YEAR FROM PURCHASE. THIS WARRANTY DOES NOT COVER THE COST OF INSTALLATION, REMOVAL OR REINSTALLATION, OR DAMAGE RESULTING FROM MISUSE, ABUSE, OR DAMAGE FROM IMPROPER WIRING OR INSTALLATION. THIS WARRANTY DOES NOT COVER INCIDENTAL OR CONSEQUENTIAL DAMAGES. LUTRON'S LIABILITY ON ANY CLAIM FOR DAMAGES ARISING OUT OF OR IN CONNECTION WITH THE MANUFACTURE, SALE, INSTALLATION, DELIVERY, OR USE OF THE UNIT SHALL NEVER EXCEED THE PURCHASE PRICE OF THE UNIT.

This warranty gives you specific legal rights, and you may have other rights which vary from state to state. Some states do not allow the exclusion or limitation of incidental or consequential damages, or limitation on how long an implied warranty may last, so the above limitations may not apply to you. This product may be covered under the following U.S. patent: 4,992,709; and corresponding foreign patents. U.S. and foreign patents pending. Lutron, Claro, and Maestro are registered trademarks and FASS is a trademark of Lutron Electronics Co., Inc. NEC is a registered trademark of the National Fire Protection Association, Quincy, Massachusetts.

© 2006 Lutron Electronics Co., Inc.



033-100



033-100

LUTRON®

Lutron Electronics Co., Inc.
7200 Suter Road
Coopersburg, PA 18036-1299, U.S.A.
Made and printed in the U.S.A. 4/06 P/N 033-100 Rev. B

Canopy Module Installation

1 Install fan.

- Install fan according to manufacturer's instructions and check for proper operation.

2 Set fan speed and lights.

- Set fan to highest speed and turn lights on using pull chains.
- If two switches control the fan and light separately, note which controls the light.

3 Turn OFF power.

- Turn power OFF at circuit breaker (or remove fuse).

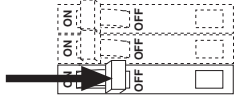

4 Disconnect fan.

- Remove canopy enclosure from ceiling fan mounting bracket.
- If separate wires from the junction box power the fan and light, tag the wire connected to the light wire. In Step 5, connect this wire to the black Canopy Module wire.
- Leave any green ground wires connected as directed in fan manufacturer's instructions.
- Disconnect fan from remaining wiring in the ceiling.

Typical Wire Colors	
Fan	Black
Light	Black with White stripe or Blue
Neutral	White

If the fan and light do not have separate wires, the fixture may have a control system built into the motor and cannot be used with this product.

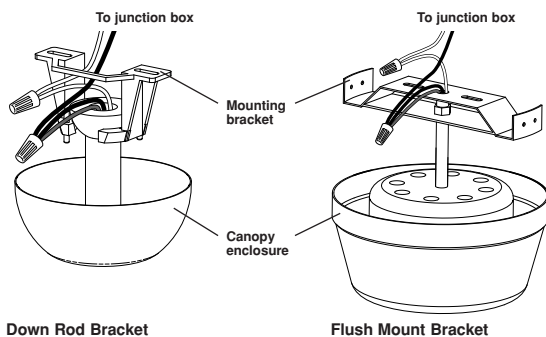

Important Wiring Information

When making wire connections, follow the recommended strip lengths and combinations for the supplied wire connector (see wire connector bag). **Note:** All wire connectors provided are suitable for **copper wire only**. For aluminum wire, consult an electrician.

Wire Connectors:

Use to join 14 AWG or 12 AWG ground wire to 18 AWG Wall Control ground wire, and to join 18 AWG Canopy Module wire to 12, 14, 16 or 18 AWG wire.

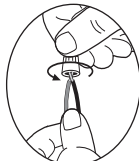

Twist wire connector tight.

5 Connect Canopy Module.

- If you have questions about wiring, call the **Lutron Technical Support Center** at +1-800-523-9466.

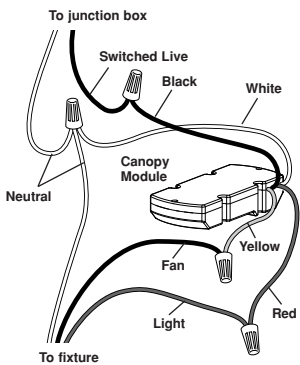

Wiring the Canopy Module (CM-L300FQ1): Use wire connectors to join wires as indicated below and in the wiring diagram (on reverse), and to **cap any unused wires**.

Canopy Module Wire:	Connects to:
White	Neutral wires in the junction box and to fan
Black	Switched Live wire from Wall Control
Yellow	Fan
Red	Light

6 Insert Canopy Module.

6a - Down Rod Bracket

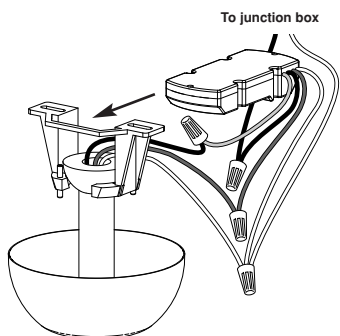

- Do not install Canopy Module in ceiling.
- Slide Canopy Module into the ceiling fan mounting bracket.

6b - Flush Mount Bracket

- Do not install Canopy Module in ceiling.
- Attach Canopy Module to bracket with a cable tie.
- Ensure cable tie does not come in contact with moving motor parts.
- Install cable tie through notches on Canopy Module. Pull tight and clip excess.

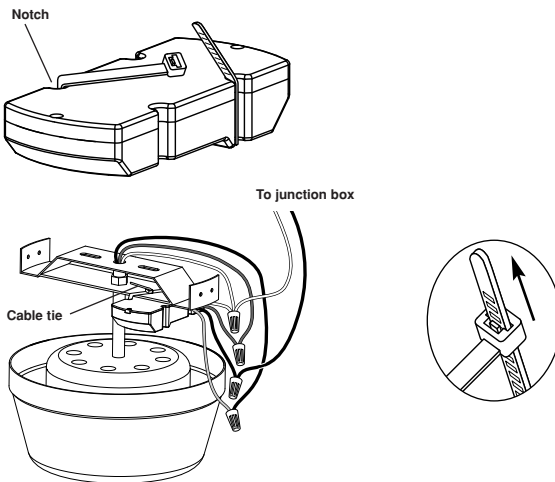

7 Attach canopy.

7a - Down Rod Bracket

- Check all wire connections.
- Tuck the wires into the junction box and/or canopy enclosure.
- Attach the canopy enclosure to the fan mounting bracket, taking care not to pinch any wires.

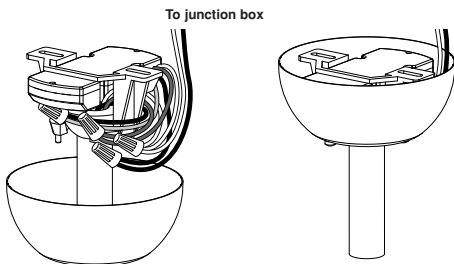

7b - Flush Mount Bracket

- Check all wire connections.
- Tuck the wires into the junction box and/or bracket.
- Ensure wires and/or wire connectors do not come in contact with moving motor parts.
- Attach the canopy enclosure to the fan mounting bracket, taking care not to pinch any wires.

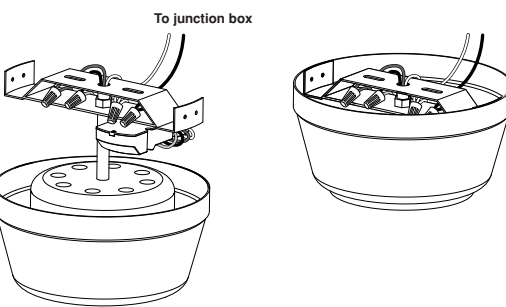

Wall Control Installation

8 Remove original wallplate and switch.

- Remove the wallplate and switch mounting screws.
- Carefully remove switch from wall (**do not remove wires**).



Danger: Verify power to switch is OFF before proceeding.

9 Identify switch wires.

- If two switches control the fan and light separately, tag the wires connected to the light switch. In Step 11, connect these wires to the Wall Control.

Important Note:

Your wall switch may have two wires attached to the same screw (see illustrations below for examples). Tape these two wires together before disconnecting. When wiring, connect wires to the Wall Control the same way they were connected to the switch.

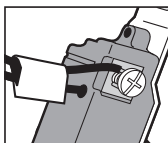

One wire in the push-in terminal and one to the screw.

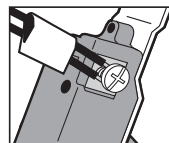

One continuous wire to the screw.

10 Disconnect switch wires.

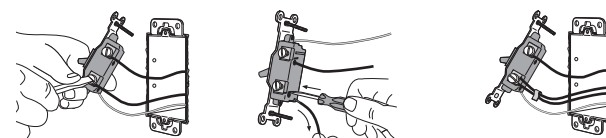

Screw Terminals: Turn screws to loosen.

Push-in Terminals: Insert screwdriver. Pull wire out.

Looped Wire: Turn screw to loosen.

Important Wiring Information

Trim or strip wallbox wires to the length indicated by the strip gauge on the back of the dimmer

Push-in Terminals: Insert wires fully. **NOTE:** Push-in terminals are for use with 14 AWG **solid copper wire only**. DO NOT use stranded or twisted wire.

OR

Screw Terminals: Tighten securely. Screw terminals are for use with 12 or 14 AWG **solid copper wire only**. DO NOT use stranded or twisted wire.

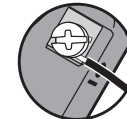
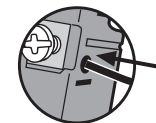

11 Connect Wall Control.

- For installations involving more than one control in a wallbox, refer to Multigang Installations before beginning.
- Remove the wallplate before proceeding with installation. This will expose Wall Control mounting holes and prevent wallplate damage while installing. Grasp *Claro* wallplate at top and pull forward to remove.

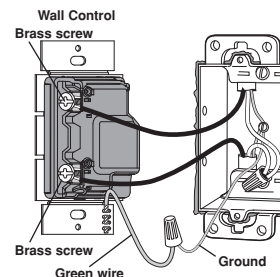

Wiring the Wall Control (MA-LFQ35): See reference wiring diagram (on reverse).

- Connect either of the wires removed from the switch to one of the **brass screw** terminals on the Wall Control, or insert fully into the push-in terminal.
- Connect the remaining wire removed from the switch to the other **brass screw** terminal on the Wall Control, or insert fully into the push-in terminal.
- Use wire connectors to connect the **green** ground wire on the Wall Control to the **bare copper** or **green** ground wire in the wallbox (See Important Note 3), and to **cap any unused wires**.

12 Mount Wall Control to wallbox.

- Form wires carefully into the wallbox, mount and align the Wall Control.
- Replace the wallplate.

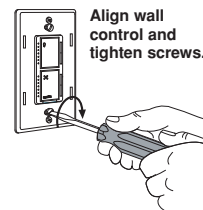

Caution: Do not overtighten mounting screws.

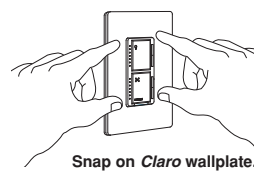

Snap on *Claro* wallplate.

13 Turn ON power.

- Do not turn on power until Wall Control and Canopy Module have been installed and wired.
- Turn power ON at circuit breaker (or replace fuse).

Warning: Fan will return to full speed when power is restored. Clean up any tools or ladders near the fan first.

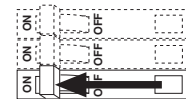

14 Activate system.

- Pull out the Front Accessible Service Switch (FASS) at the bottom of the Wall Control, wait 10 seconds, then push it back in.
- The LEDs will cycle for up to 30 seconds.
- If installing more than one Wall Control/Canopy Module system, activate one at a time with FASS pushed in on all other systems.

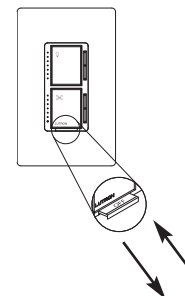

15 Recommended - Disconnect pull chains.

- Disconnect pull chain extensions to prevent light and fan speeds from being adjusted at the fan.