

RadioRA 2 RF Plug-In Modules

RadioRA 2 RF Plug-in Modules are simple to install and easy to use. RF Plug-in Modules allow floor and table lamps (RR-3PD-1) as well as general purpose switching loads (RR-15APS-1) to be added to a system quickly and easily using Clear Connect™ RF Technology. They can be hidden behind furniture or appliances.

The RadioRA 2 Dimming Module (RR-3PD-1) functions much like standard lamp dimmers, but also incorporates advanced features such as fade on/fade off, delayed long fade off, and rapid full on.

The RadioRA 2 Appliance Module (RR-15APS-1) switches up to 15 A of general purpose loads. It features Lutron's patented Softswitch® technology to prevent the relay contacts from arcing, extending the average life of the switch.



RR-3PD-1



RR-15APS-1

Model Numbers

- RR-3PD-1-XX* 300 W/300 VA Dimming Module (1 receptacle)
- RR-15APS-1-XX* 1/2 HP or 15 A General Purpose Plug-In Appliance Module (1 receptacle)

*See **Colors and Finishes** below.

Colors and Finishes

RadioRA 2 RF Plug-In Modules are available in 2 colors.



Snow
SW



Midnight
MN

RadioRA 2 RF Plug-In Modules

Specifications

Model Numbers	RR-3PD-1-XX, RR-15APS-1-XX
Power	120 V~ 50/60 Hz
Typical Power Consumption	0.3 W Test conditions: load is off.
Regulatory Approvals	cUL, UL, FCC, IC, SCT, NOM (-3PD only; -15APS pending)
Environment	Ambient operating temperature: 32 °F to 104 °F (0 °C to 40 °C), 0% to 90% humidity, non-condensing. Indoor use only.
Communications	Plug-In Modules communicate with the system through Radio Frequency (RF) and must be located within 30 ft (9 m) of a repeater. System devices operate on frequencies between 431.0 MHz and 437.0 MHz.
ESD Protection	Tested to withstand electrostatic discharge without damage or memory loss, in accordance with IEC 61000-4-2.
Surge Protection	Tested to withstand surge voltages without damage or loss of operation, in accordance with IEEE C62.41-1991 Recommended Practice on Surge Voltages in Low-Voltage AC Power Circuits.
Power Failure	Power failure memory: should power be interrupted, the RF Plug-In Module will return to its previous state when power is restored.
Warranty	1 Year Limited Warranty. http://www.lutron.com/resiinfo

Design Features

Dimming Module (RR-3PD-1)

- On a single-tap of the toggle button, lights fade ON or OFF.
- On a double-tap of the toggle button, lights go to full ON.
- When ON, press and hold the toggle button to engage the delayed long fade to OFF.
- Light levels can be fine-tuned by pressing and holding the raise/lower buttons until the desired light level is reached.
- Control non-dimmable lighting loads in switching mode.

Appliance Module (RR-15APS-1)

- On a single-tap of the toggle button, load toggles ON or OFF.
- The appliance module may be used with, but is not limited to, the following:
 - Task lighting
 - Monitors
 - Fans
 - Humidifiers
 - Printers
 Note: Refer to the manufacturer's guidelines for acceptable switching methods.
- The appliance module may NOT be suitable for use with devices that require any of the following:
 - Shut-down process before power is interrupted, such as computers.
 - Cool-down process before power is interrupted, such as projectors.
 - Programming, such as clocks or DVRs.
 - Long warm-up cycle.
- If an over-temperature condition is detected, the LED on the unit will flash a unique sequence (double-blink, then pause) and turn the load off. Proper installation and conformance to all specifications should be ensured before proceeding. To return the device to normal operation, cycle power to the device.

RadioRA 2 RF Plug-In Modules

Dimensions

All dimensions are shown as $\frac{\text{in}}$ (mm) unless otherwise noted. Images below are for reference only.

Front View

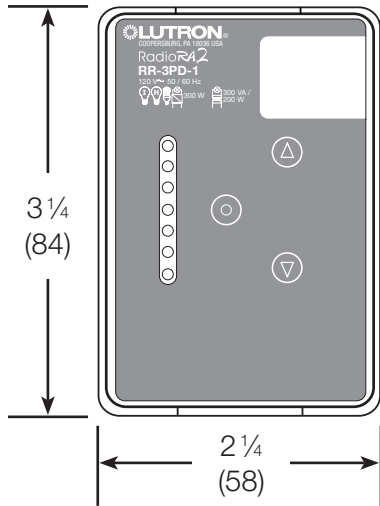

Side View

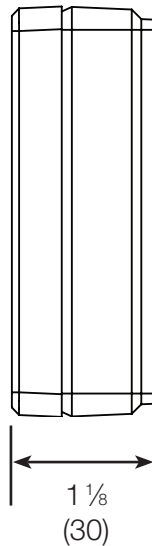

Cord Length

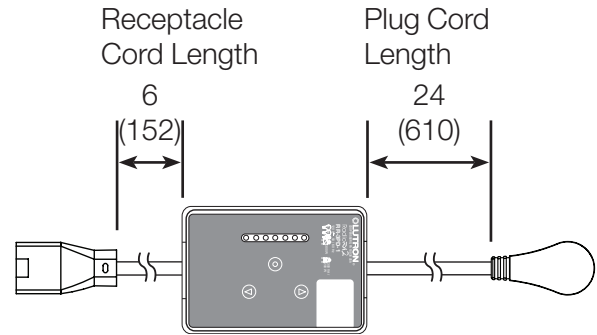

Dimming Module (RR-3PD-1)

Plug

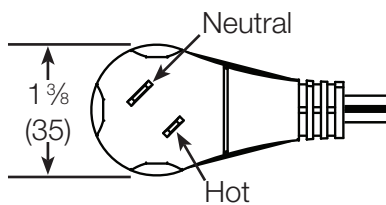
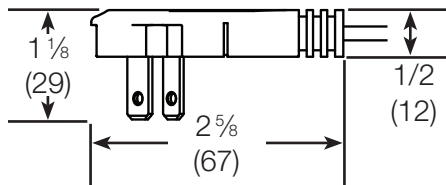

Appliance Module (RR-15APS-1)

Plug

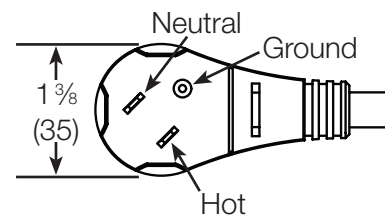
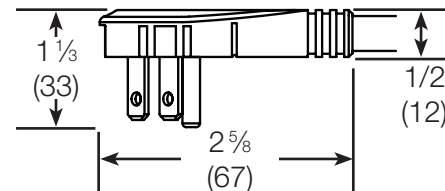

Receptacle

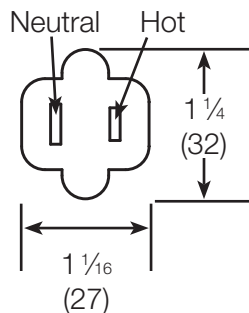
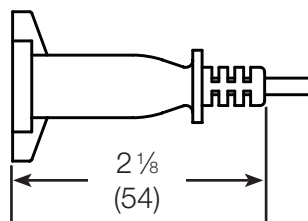

Receptacle

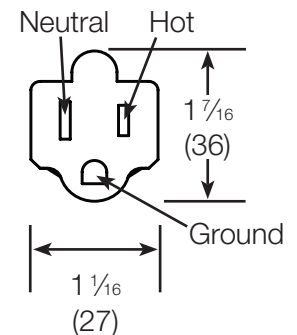
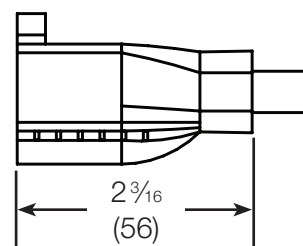

RadioRA 2 RF Plug-In Modules

Installation

Plug the load cord into a Plug-In Module receptacle.

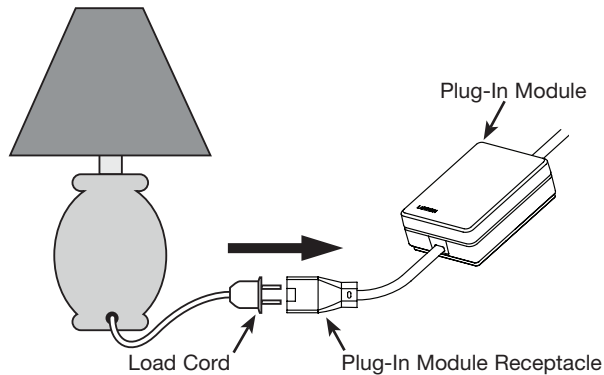

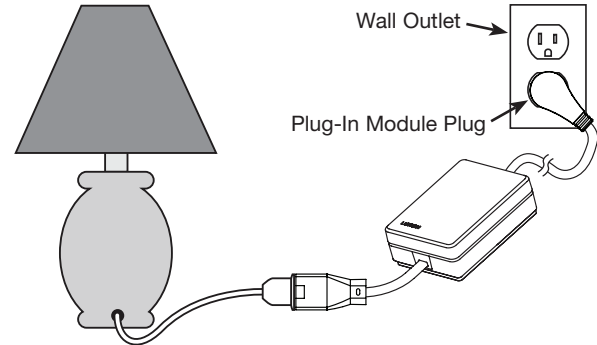

Insert the plug of the Plug-In Module into the wall outlet.



NOTE: The Plug-In Dimming Module contains a **POLARIZED** cord set. It has a polarized plug (one blade is wider than the other) and outlet (one slot is wider than the other). The polarized plug is not intended to be mated with non-polarized outlets (having both slots the same size). The polarized outlet is intended to mate with a polarized plug in only one way (the longer slot with the wider blade).

Load Type and Capacity

Control	Load Type	Min. Load	Max. Load
3PD-1 ¹	 Incandescent, Halogen	10 W	300 W
	 MLV ²	10 W/VA	200 W / 300 VA
	 CFL, Fluorescent, ELV (Switching Mode Only)	10 W	300 W
15APS-1 ³	General purpose	None ⁴	1/2 HP 15 A

¹ The RR-3PD-1 is designed to dim one incandescent, magnetic low-voltage, or tungsten halogen table or floor lamp. The RR-3PD-1 can be configured to switch a CFL, fluorescent, or electronic low-voltage load. Use with lighting loads only. Do not use to control a lamp that contains an integral dimmer or a touch lamp. For a lamp with an integral 3-way switch, the switch should be set to full on position. The RR-3PD-1 may not work with dioded light bulbs. Always use a load that complies with the **Load Type and Capacity** table above. Always use a light bulb that remains within the wattage rating of the light fixture.

² Low-Voltage Applications: The RR-3PD-1 can be used with magnetic (core and coil) low-voltage transformers in both dimming and switching modes. Use with electronic (solid-state) low-voltage transformers in switching mode only. Operation of a low-voltage circuit with light bulbs inoperative or removed may result in transformer overheating and premature failure. Lutron strongly recommends the following:

- Do not operate low-voltage circuits without operative light bulbs in place.
- Replace burned-out light bulbs as soon as possible.
- Use transformers that incorporate thermal protection or fused transformer primary windings to prevent transformer failure due to overcurrent.

³ The RR-15APS-1 is designed to switch general purpose loads (lighting, non-lighting, motor-operated, or transformer supplied appliances). Total connected load can not exceed 1/2 HP, or 15 A. Peak horsepower is not reflective of the UL appliance horsepower rating. Consult appliance manufacturer for UL horsepower rating.

⁴ Some low wattage loads may try to start when the Appliance Module is OFF due to 0.5 mA leakage current through the module, similar to a night lighted toggle switch. Consult the load manufacturer for compatibility.

RadioRA 2 RF Plug-In Modules

Operation

Dimming Module (RR-3PD-1)

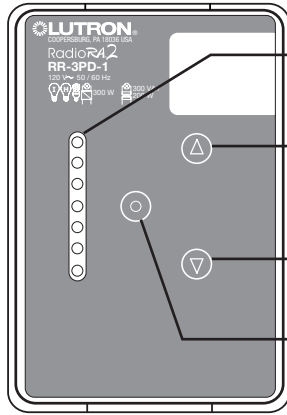

Status LEDs

Indicate light level; glow softly as night light when load is off

Raise Button

Press to brighten

Lower Button

Press to dim

Toggle Button

Press to toggle ON/OFF; double-tap for full ON; press and hold while ON for delayed long fade to OFF.

Appliance Module (RR-15APS-1)

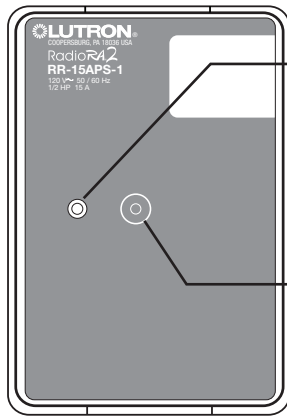

Status LED

Indicates load status; glows softly as night light when load is off

Toggle Button

Press to toggle ON/OFF.