

# WS-301/WS-301-347

## Passive Infrared Wall Switch Occupancy Sensor

# Installation Instructions

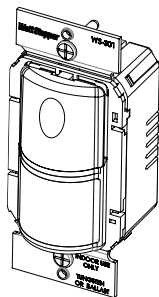

WS-301

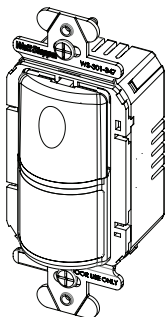

WS-301-347

### SPECIFICATIONS

**WS-301 Voltages** ..... 120 or 277VAC, 50/60Hz

Load Requirements

@ 120VAC.....0~1000W ballast, E-ballast, LED, tungsten, 1/4 hp

@ 277VAC .....0~1200W ballast, E- ballast & LED, 1/4 hp

**WS-301-347 Voltage** ..... 347VAC, 50/60Hz

Load Requirements.....0~1500W ballast & LED, 1/4 hp

### Common Features

Time Delay Adjustment .....30 seconds - 30 minutes

Sensitivity Adjustment ..... Minimum-Maximum

Light Level Adjustment..... 0-200fc (@4000K)

Operating Temperature .....40°C (104°F)

Storage Temperature .....70°C (158°F)

Terminal screw torque ..... 16 lbf-in (18 kgf-cm)

Optional Neutral Connection

**WattStopper®**

## UNIT DESCRIPTION AND OPERATION

The WS-301 and WS-301-347 PIR Wall Switch Occupancy Sensors turn lighting or fan loads ON and OFF based on occupancy and ambient light level. They are designed to replace a standard light switch. The WS-301 operates with 120 or 277VAC line voltage and the WS-301-347 operates with 347VAC line voltage. All other features are the same in both models. (Throughout this manual, "WS" is used to indicate either sensor.)

The sensor uses passive infrared technology to sense human motion, and defines it as occupancy. A red LED on the sensor blinks upon occupancy and then resets. It will blink again when it detects motion after the 2-second reset.

The sensor turns ON the load automatically when it detects occupancy. Once the space is vacant and the time delay elapses, it turns OFF the load automatically.

If adequate ambient light is already present in the area, the sensor will hold OFF the load it controls. When the light drops below a field selectable level and the sensor detects occupancy, the sensor turns ON the load. Once turned ON, the load remains ON until the space is vacant or the light level rises above the setpoint and the time delay expires.

**Manual Operation:** The occupant can press the ON/OFF button to turn the load ON and OFF. When the load is turned ON manually, the sensor will keep the load ON until no motion is detected for the length of the time delay. If the load is turned OFF manually, the sensor holds the load OFF until no motion has been detected for the duration of 5 minutes. The next time the sensor detects occupancy and the ambient light is lower than the set level, the sensor automatically turns ON the load.

### Walk-test feature:

When the Time Delay trimpot is in the fully counterclockwise position, the sensor has a 30 second time delay. This allows you to quickly check the sensor coverage area.

### Service function:

In the event of unit failure or if it is necessary to leave the load ON, remove the Service Jumper plug. This disables all automatic ON and OFF functions and the load can only be operated using the ON/OFF button.

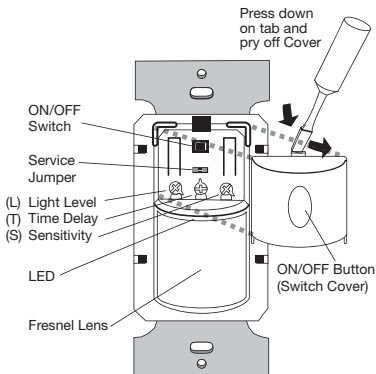

Maximum = clockwise

Minimum = counterclockwise

**Call 800.879.8585 for Technical Support**

## COVERAGE PATTERNS

The WS detects motion in areas up to 900 sq. ft. and up to 35 feet from the sensor. Ideally, the sensor is designed for small amounts of motion in spaces up to 300 sq. ft. The Fresnel lens on the sensor is a multiple segment viewing lens with a field of view of 180°.

The sensor must have a clear view of the people in the space in order to detect occupancy. Obstructions, such as furniture blocking the sensor's lens, may prevent occupancy detection.

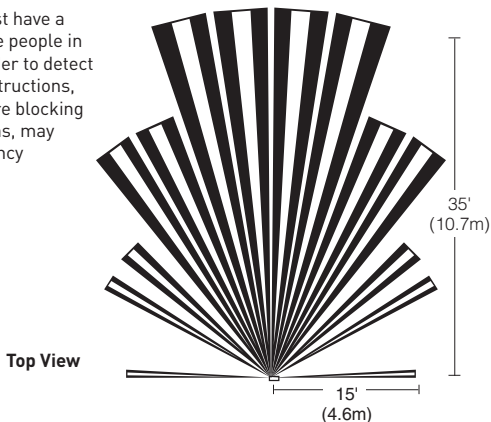

Top View



Side View

### Masking the lens

Opaque adhesive tape is supplied so that sections of the sensor's view can be masked. This allows you to eliminate coverage in unwanted areas.

Since masking removes bands of coverage, remember to take this into account when troubleshooting coverage problems.

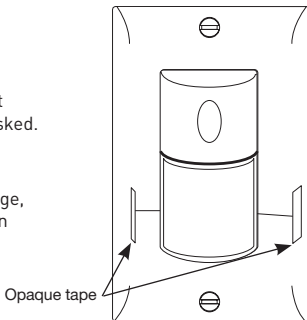

Visit our website for FAQs: [www.wattstopper.com](http://www.wattstopper.com)

## INSTALLATION



CAUTION



Turn the power **OFF** at the circuit breaker before installing the sensor.

1. Connect the existing wires in the wall box to the sensor flying leads. (See Wiring Directions).
  - Do not allow bare wire to show below connector.
  - The ground wire must be **tightly grounded** for the unit to operate properly.
2. Attach the sensor to the wall by mounting it in the wall box with the two mounting screws provided.
3. Turn ON power at the circuit breaker.
4. Test the sensor using the procedure in the Sensor Adjustments section.

**There is an initial warm-up period after installation.** It may take up to a minute before the load turns ON due to a sensor warm-up period during initial power-up (this occurs during installation only). The load turns ON after the warm-up period ends if the sensor detects motion.

**Rapid successive pressing of the ON/OFF button causes a delay in function.** A single press of the button causes an immediate response. If the button is pressed again within 2 seconds, the switch ignores it if there is not enough power. Wait at least two seconds between button presses.

5. Install industry standard decorator wall switch cover plate (not included).

### Optional Neutral Wiring

For applications requiring neutral wiring, remove tab as shown to expose terminals for wiring.

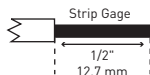
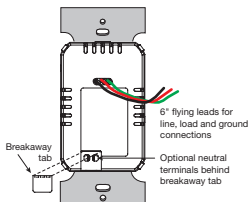

Cu Wire Only  
#12-#14 AWG

Call 800.879.8585 for Technical Support

## WIRING DIRECTIONS

For normal installation of the WS-301 and WS-301-347, connect:

1. LOAD to Red flying lead.
2. LINE to Black flying lead.
3. GROUND to Green .

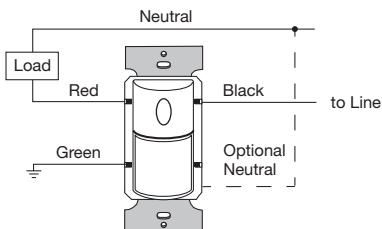

Single-level wiring

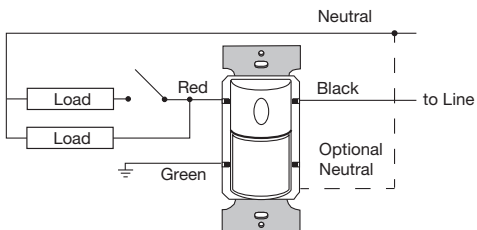

Manual bi-level lighting wiring

## SENSOR ADJUSTMENT



**DO NOT OVERTURN TRIMPOTS WHEN ADJUSTING THE SENSOR!**

1. To test unit operation, press the ON/OFF button to turn the load ON.
2. Remove the button cover to access the adjustment controls. Use a small, flat blade screwdriver to press down the locking tab at the top of the button, then gently pry it off.
  - a) Set the time delay to the "walk test" position (fully counterclockwise).
  - b) Leave the room. The load should go OFF after 30 seconds.
3. To test sensitivity:
  - a) Make no motion for 3 seconds.
  - b) Wave your hand sideways in front of the sensor at a distance of approximately 12". The LED blinks when movement is detected. Typically, the sensitivity should be at maximum (fully clockwise).
4. If desired, set the light level using the steps below. The light level values referenced are approximate and reference 4000K CCT. Variations in color temperature may affect the actual levels the sensor sees. It is recommended that light level hold off be set up in the morning for best results. [If this feature is not needed, leave the light level at maximum (fully clockwise)].
  - a) Set the Time Delay to the "walk test" position (fully counterclockwise).
  - b) Set the Light level to 50% (12 o'clock position) which is approximately 100fc. Let the sensor time out so lights are OFF. Enter the space and lights should remain OFF.
  - c) Make sure your body does not cast a shadow on the sensor, and adjust the light level trimpot clockwise in small increments.
  - d) After each adjustment, wait 5-10 seconds to see if the lights turn ON. Repeat until the lights turn ON. At this setting the load connected to the sensor will not turn ON if light levels are above the current illumination. If you are unable to find the ON position, your space may be below 100fc. In this case, start your set point below 50%. Typically, most applications would require 100 or more foot candles.

**Note:** Users can override this function by placing their hand in front of the sensor to block incoming light. The load will then remain ON until the space is unoccupied or the light level rises above the setpoint and the time delay expires.
5. Reset the time delay to the desired setting. The time delay can be set from 30 seconds to 30 minutes in 5-minute increments.

Visit our website for FAQs: [www.wattstopper.com](http://www.wattstopper.com)

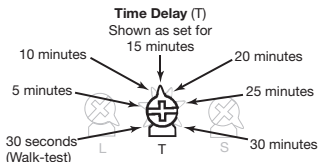

## TROUBLESHOOTING

### Load will not turn ON:

- LED does not flash:
  - Check the sensitivity for proper configuration.
  - Check all wire connections. Verify the ground wire is tightly secured.
- LED does flash:
  - Press the ON/OFF button. If load does not turn ON, check all wire connections and verify the load wire is tightly secured.
  - Check the light level trimpot.
    - If light level feature is desired, follow the steps from the Sensor Adjustment.
    - If light level feature is not desired, turn trimpot fully clockwise to disable.
- If load still does not turn ON, call 800.879.8585 for technical support.

### Load will not turn OFF:

- The time delay can be set for 30 seconds (Walk Test), 5, 10, 15, 20, 25, or 30 minutes. Ensure that the time delay is set to the desired delay and that there is no movement within the sensor's view for that time period.
- To quickly test the unit for proper operation, turn the time delay to minimum (fully counterclockwise) and move out of the sensor's view. Load should turn OFF after 30 seconds.
- If load still does not turn OFF, call 800. 879.8585 for technical support.

### Sensing motion outside desired area:

- Opaque adhesive tape is included with the sensor and can be used to limit the detection areas. See Masking the Lens.
- Adjust sensitivity counterclockwise to reduce excessive sensitivity.

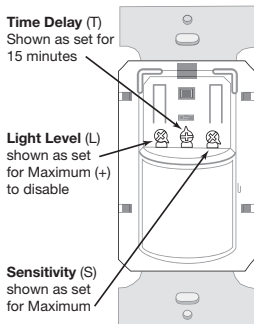

**Call 800.879.8585 for Technical Support**

## COVER PLATES

WattStopper WS wall switches fit behind industry standard decorator style switch cover plates.

## WARRANTY INFORMATION

WattStopper warrants its products to be free of defects in materials and workmanship for a period of five (5) years. There are no obligations or liabilities on the part of WattStopper for consequential damages arising out of, or in connection with, the use or performance of this product or other indirect damages with respect to loss of property, revenue or profit, or cost of removal, installation or reinstallation.

**WattStopper®**

2800 De La Cruz Boulevard, Santa Clara, CA 95050  
800.879.8585 • [www.wattstopper.com](http://www.wattstopper.com)

Please  
Recycle

