

PANELITE ENCLOSURE LIGHTS



INDUSTRY STANDARDS

PANELITE LED and Fluorescent Enclosure Lights

UL 508A Component Recognized; File No. E61997
 cUL Component Recognized per CSA C22.2 No 14; File No. E61997

CSA File No. 42186
 Maintains UL/CSA Type 4, 4X and 12 enclosure rating when properly installed in a Hoffman enclosure.

230 VAC Fluorescent Enclosure Light

UL 508A Component Recognized; File No. E234324
 cUL Component Recognized per CSA C22.2 No 14; File No. E61997

CE

LED Light

UL 508A Component Recognized; File No. E234324
 cUL Component Recognized per CSA C22.2 No 14; File No. E234324

CE

Ingress protection : IP 20

Maintains enclosure type rating up to 4X when installed per instructions

APPLICATION

Versatile, slim-profile LED and fluorescent lights provide mounting flexibility and are easy to install in any enclosure. Terminal blocks allow for easy wiring. Accessories include ganging cables, power cords and door switches, all provided with plug-and-play connectors for easy connection to the terminal blocks with an innovative terminal connection system. LED version provides superior lighting performance with minimal power consumption.

FEATURES

- Slim profile allows light to be tucked out of the way for easy panel installation
- Versatile mounting allows the light to be positioned horizontally or vertically; two-way mounting provides for ideal orientation
- Includes mounting hardware for the following enclosure installations: PROLINE Frame, Enclosure Top, Panel Mount and Unistrut
- On/off switch incorporated in light; optional remote door switch accessory available to activate light when enclosure door is opened (230 VAC Fluorescent Enclosure Light has switch or door-activated sensor)

PANELITE Only:

- Mounting tabs provide easy access point for attachment hardware; light does not need to be disassembled for installation
- Up to five lights can be daisy-chained together
- Plug-and-play terminal connection system:
 - Pre-wired connection sockets on both ends of light allow use of Hoffman cable accessories
 - Optional terminal blocks snap into the connection sockets, allowing customers to use their own wiring methods; two terminal blocks provided with each light kit
 - Power supply can be wired manually with Hoffman PANELITE Power Cable with Leads or with Hoffman optional PANELITE Power Cord
 - Ganging cables are available in 2-, 4- and 6-ft. lengths to easily join up to five lights together using one power supply
 - Remote door switch for easy door activation eliminates need to mount light in the exact location required to activate the light

LED Light Only:

- Mechanical screw- or magnetic mount (non-slip rubberized)
- Protection Class II (double insulated)
- Operating temperature -22 F to 140 F (-30 C to 60 C)
- On / Off or motion-sensor activation
- LED lights with 400 LM illumination; 120° angle of illumination
- Low, 5-watt power requirement
- Light-weight, all-composite construction
- Input and output connectors included with light (16 AWG)

SPECIFICATIONS

PANELITE:

- Extruded aluminum center support
- Black composite end caps
- Black composite mounting tabs
- Each light fixture includes two mounting tabs, two pre-wired connection sockets, two optional terminal blocks that snap into the connection sockets and enclosure attachment hardware (bulb not included with fluorescent light)

230 VAC Fluorescent Enclosure Light:

- Light gray composite construction – UL 94V-0 material
- Hardware kit provides fasteners to mount to PROLINE, NEMA [4, 4X, 12, and 13], CONCEPT, FUSION and other cabinets
- Easy-access terminal block that accommodates up to 16 AWG wires
- Fluorescent light bulb included (2G7 Base)

LED Light:

- LED (Light Emitting Diode) low-power light kit
- Screw mounting using included hardware kit (maintains enclosure rating up to UL Type 4X)
- No user-serviceable parts
- Life expectancy of 60,000 hours at 68 F (20 C) under specifications
- Operating temperature: -22 to +140 F (-30 to +60 C) under specifications
- 5-watt power consumption
- Transparent, composite construction

PANELITE LED ENCLOSURE LIGHT



- 24 VDC operation for superior lighting performance with minimal power consumption
- 140-degree cone angle casts a broad covering of neutral light between 3500 and 4500K color temperature
- Center section rotates 120 degrees to redirect light where needed
- Long life; 70 percent of initial luminance at 50,000 hours (at 25 C)
- High power LED emitters produce 470 Lumens for superior lighting performance
- Can be wired using optional PANELITE Cable Accessories or can be hard-wired with terminal blocks included in hardware kit
- Up to five lights can be daisy-chained together using hard-wired connection to power supply or catalog number LPC72 power cable with leads

BULLETIN: A80LT

Catalog Number	Description	VDC	Amps	W in./mm	X in./mm
LED24V15	LED Light, 15 in.	24	.5	15.00 381	8.00 203

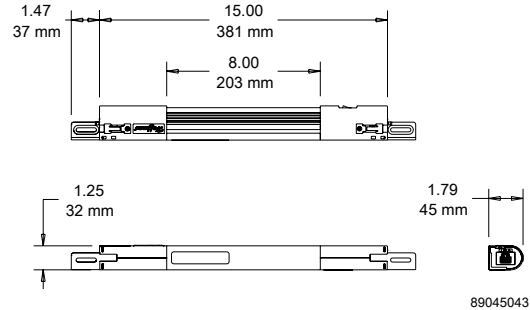

REPLACEMENT HARDWARE KIT FOR PANELITE LED AND FLUORESCENT ENCLOSURE LIGHT

Relacement hardware kit is available for the replacement of lost or damaged hardware supplied with the PANELITE LED or Fluorescent Lights. Kit includes mounting brackets and all mounting hardware.

BULLETIN: A80LT

Catalog Number	Description
LED24VHDWK	Replacement hardware kit for PANELITE Enclosure Lights

PANELITE FLUORESCENT ENCLOSURE LIGHT



- 120 VAC, 50/60 Hz operation
- Can be wired using optional PANELITE Cable Accessories or can be hard-wired with terminal blocks included in hardware kit
- Available in 15-, 18- and 28-in. lengths with ability to daisy chain up to five lights together using one power supply
- Fluorescent bulb not included

BULLETIN: A80LT

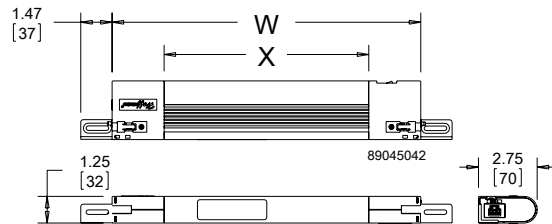

Catalog Number	Description	VAC	Hz	Amps	W in./mm	X in./mm	Bulb (purchase separately)	Replacement Lens Cover
LF120V15	Fluorescent Light, 15 in.	120	50/60	.13	14.50 368	9.63 245	F6T5	LFL15
LF120V18	Fluorescent Light, 18 in.	120	50/60	.13	17.50 445	12.63 321	F8T5	LFL18
LF120V28	Fluorescent Light, 28 in.	120	50/60	.26	27.75 705	22.88 581	F14T5	LFL28

PANELITE POWER CORDS



- Connects light to standard North American wall socket
 - LF120VCORD is for 120 VAC Fluorescent lights (up to five lights can be daisy chained together using one power cord)
 - LED24VCORD is for 24 VDC LED lights and includes a transformer to convert 100-240 VAC power supply (capable of powering only one LED light)
 - Plugs directly into a connection socket on switch end of the light
 - Includes one cable
- Power cord not required. Terminal blocks are provided with each light for wired connection to electric supply.*

BULLETIN: A80LT

Catalog Number	Description	Length
LF120VCORD	Fluorescent Light Power Cord	72 in.
LED24VCORD	LED Light Power Cord	60 in.

PANELITE POWER CABLE WITH LEADS



- 72-in. power cord provides convenient connection to an electrical supply
 - Eliminates need to run and tag individual wires into the light
 - Compatible with PANELITE LED and Fluorescent lights
 - Plugs directly into connection socket on switch end of the light
 - Includes one 16 AWG cable, black
- Power Cable not required. Terminal blocks are provided with each light for wired connection to electric supply.*

BULLETIN: A80LT

Catalog Number	Length
LPC72	72 in.

PANELITE GANGING CABLES



- Ganging Cables provide convenient method for joining up to five lights together while utilizing one power supply
 - Available in 24-, 48- and 72-in. lengths
 - Plugs directly into connection socket on either end of the light
 - Compatible with PANELITE LED and Fluorescent lights
 - Includes one 16 AWG cable, black
- Ganging Cables not required. Terminal blocks are provided with each light for hard-wired connections.*

BULLETIN: A80LT

Catalog Number	Length
LGCABLE24	24 in.
LGCABLE48	48 in.
LGCABLE72	72 in.

PANELITE DOOR SWITCH CABLE



- Easily connects PANELITE LED or Fluorescent Light to a Remote Door Switch
 - T-connector allows the Door Switch Cable to be connected with a ganging cable or power supply to the switch end of the light
 - Available in 18- and 72-in. lengths
 - Includes one 18 AWG cable, black
- Door Switch Cables not required. Terminal blocks are provided with each light for hard-wired connection to remote door switch.*

BULLETIN: A80LT

Catalog Number	Length
LDSWITCH18	18 in.
LDSWITCH72	72 in.

PANELITE WIRING OPTIONS

See the table on the drawing for cable clearance dimensions.

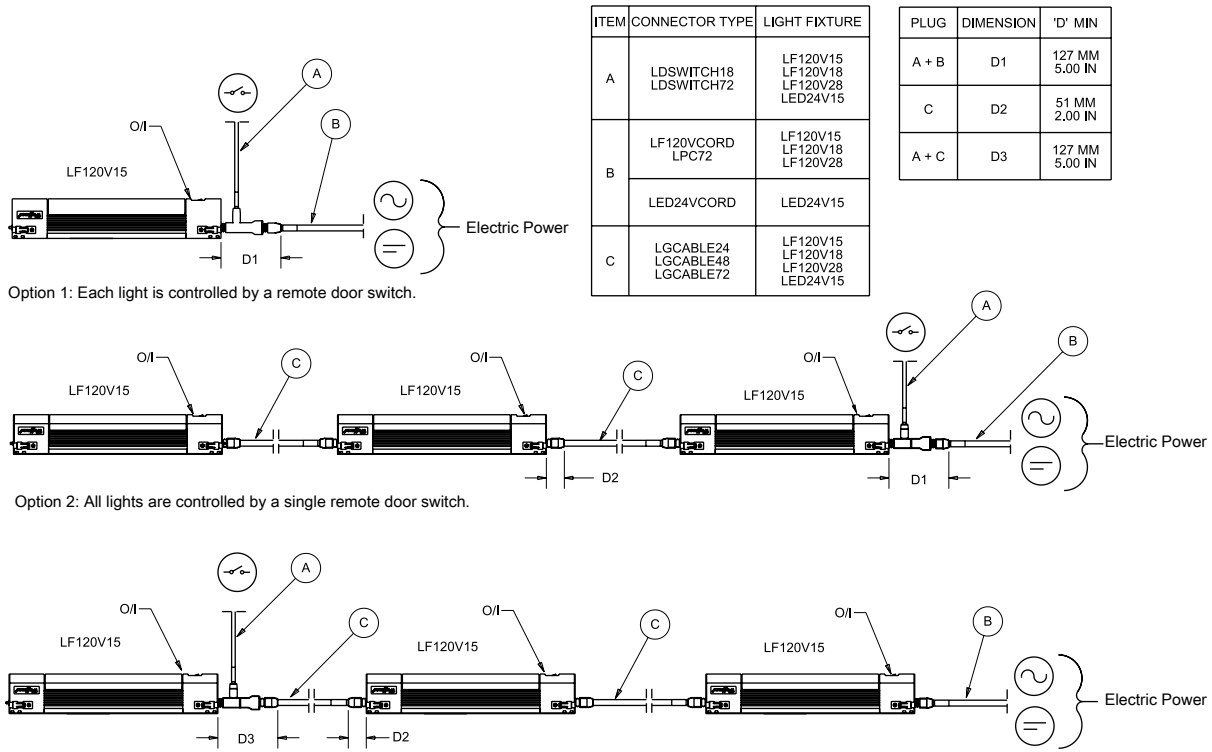

ITEM	CONNECTOR TYPE	LIGHT FIXTURE
A	LDSWITCH18 LDSWITCH72	LF120V15
		LF120V18
		LF120V28 LED24V15
B	LF120VCORD LPC72	LF120V15
		LF120V18 LF120V28
C	LGCABLE24 LGCABLE48 LGCABLE72	LF120V15
		LF120V18
		LF120V28
		LED24V15

PLUG	DIMENSION	'D' MIN
A + B	D1	127 MM 5.00 IN
C	D2	51 MM 2.00 IN
A + C	D3	127 MM 5.00 IN

Option 1: Each light is controlled by a remote door switch.

Option 2: All lights are controlled by a single remote door switch.

Option 3: The last light is controlled by a remote door switch. The first two lights are manually operated.

89046495

230 VAC FLUORESCENT ENCLOSURE LIGHT



- 230 VAC, 50/60 Hz operation with electronic ballast
- Compact light-gray plastic housing, UL 94V-0
- Easy access to wiring terminals, integral strain relief, 16 AWG max.
- Versatile mounting to many enclosure types
- Complete assembly, long-life fluorescent bulb included, Luminosity 900 LM
- Switch and Door motion sensor offering

BULLETIN: A80LT

Catalog Number	AxBxC in./mm	Description
LF230VM	1.57 x 13.58 x 3.58 40 x 345 x 91	Light Kit, 230VAC, Manual switch
LF230VD	1.57 x 13.58 x 3.58 40 x 345 x 91	Light Kit, 230VAC, IR Motion Sensor

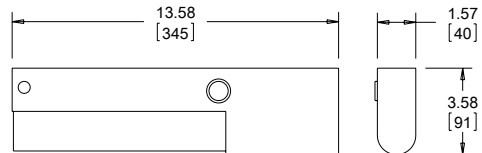

89077693

LED LIGHT KIT

LED light kits provide interior enclosure lighting. These light kits are ideal for remote and darkened enclosure applications. The light can be mechanically fastened with included hardware to maintain enclosure UL listing (up to Type 4X), or can be magnetically attached to flat steel surfaces. The lights have auto-sensing circuitry (AC voltage 90 VAC to 265 VAC and DC voltage 20 VDC to 60 VDC). LED lights are light-weight and in a small form factor while providing 400 LM of 6000-7000K light. Power consumption for all models is 5 watts.

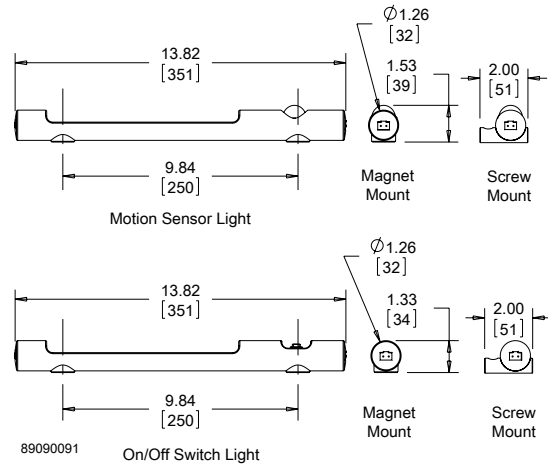
BULLETIN: A80LT

Catalog Number	AxBxC in./mm	Weight (oz)	Weight (gm)	Mounting Style	Power Source	Activation	Voltage
LEDA1M35	1.34 x 1.26 x 13.82 34 x 32 x 351	4.8	135	Magnetic	AC	On/off switch	90 VAC-265 VAC
LEDA2M35	1.54 x 1.26 x 13.82 39 x 32 x 351	5.0	140	Magnetic	AC	IR Motion Sensor	90 VAC-265 VAC
LEDA1S35	1.42 x 2.05 x 13.82 36 x 52 x 351	4.8	135	Screw	AC	On/off switch	90 VAC-265 VAC
LEDA2S35	1.63 x 2.05 x 13.82 41 x 52 x 351	5.0	140	Screw	AC	IR Motion Sensor	90 VAC-265 VAC
LEDD1M35	1.34 x 1.26 x 13.82 34 x 32 x 351	4.8	135	Magnetic	DC	On/off switch	20 VDC-60 VDC
LEDD2M35	1.54 x 1.26 x 13.82 39 x 32 x 351	5.0	140	Magnetic	DC	IR Motion Sensor	20 VDC-60 VDC
LEDD1S35	1.42 x 2.05 x 13.82 36 x 52 x 351	4.8	135	Screw	DC	On/off switch	20 VDC-60 VDC
LEDD2S35	1.63 x 2.05 x 13.82 41 x 52 x 351	5.0	140	Screw	DC	IR Motion Sensor	20 VDC-60 VDC

LED LIGHT INPUT CONNECTOR/CABLE ASSEMBLY

The input connector/cable assembly is used to provide supply power to the LED light. Preassembled connector/cable assembly

with 78.7-in. (2000 mm) long cable whip. Cables are constructed of 16 AWG copper wire.

BULLETIN: A80LT

Catalog Number	A in./mm	Power Source	Use with
LEDA20C	78.74 2000	AC	AC LED Lights
LEDD20C	78.74 2000	DC	DC LED Lights

LED LIGHT EXTENSION CONNECTOR/CABLE ASSEMBLY

The extension connector/cable assembly is used to connect adjacent LED lights (daisy chain). Up to 10 LED lights can be ganged or connected in series. Pre-assembled connector/cable assembly with 39.4-in. (1000 mm) long cable between input and output connectors. Cables are constructed of 16 AWG copper wire.

BULLETIN: A80LT

Catalog Number	A in./mm	Power Source	Use with
LEDA10E	39.37 1000	AC	AC LED Lights
LEDD10E	39.37 1000	DC	DC LED Lights

REMOTE DOOR SWITCHES

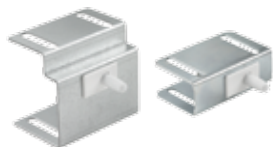

- The remote door switch can activate a light or other electrical component when the enclosure door is opened
- Mounts on enclosure frame and includes mounting hardware
- Mounting plate is 14 gauge steel with a plated finish
- Can be hard-wired to the PANELITE LED or Fluorescent light or connected via the PANELITE Door Switch Cable

BULLETIN: A80LT, P20

Catalog Number	Description
ALFSWD	Door switch assembly (order connection cable separately)
PLFSWD	Door switch assembly for PROLINE and PROLINE G2 (order connection cable separately)

TOUCH-SAFE UL LIGHT SWITCH

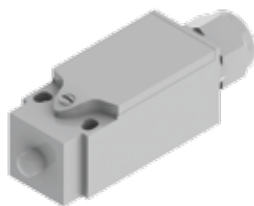

APPLICATION

The Touch-Safe light switch is designed to be used with Hoffman light kits (AC and DC). It provides a UL listed touch-safe switch that can be used on many enclosure types and includes hardware for most applications. The light switch maintains enclosure overall rating up to UL 508A Type 4X or 12.

FEATURES

- UL listed for a touch-safe wire connection
- Easily mounted to various enclosure types; common bracket and hardware included for many enclosure types (NEMA, CONCEPT/ FUSION G7, PROLINE, Free-Stand Type 12)
- Cable PG compression hub
- Wide operating temperature range: -49°F to +158°F [-45°C to 70°C]
- Rugged die-cast anodized zinc construction
- Connection 3 cage clamps for solid and stranded wire AWG 20-14 (0.5-2.5mm²)
- Protection class I (grounded)

BULLETIN: A80LT

Catalog Number	Max. Cable Dia.	Max. Voltage
LDSWITCH	.375 in.	250 AC / 48 DC

MOUNTING BRACKET KIT FOR LIGHT PACKAGE



Kit simplifies mounting light package in Hoffman PROLINE disconnect enclosures. Includes brackets, all mounting hardware and complete instructions.

BULLETIN: A80LT

Catalog Number	Description
PDLFBRKT	Mounting Bracket Kit

LED PUCK LIGHT



The LED Puck Light is ideal for remote and darkened applications. This versatile light provides mounting flexibility; it can be magnetically attached to flat steel surfaces or can be hung with a swivel hook. This small form factor, light-weight LED light provides superior lighting performance with minimal power consumption. It can be used as a three-LED flashlight or as a 24-LED work light with operating temperature of 40 F to 120 F (4 C to 48 C). An on/off switch is incorporated in the light and three AAA batteries are included.

BULLETIN: A80LT

Catalog Number	AxBxC in./mm	Product Weight
LEDPUCK	2.25 x 3.75 x 1.38 57 x 95 x 35	0.22 lbs.

