

# FITTINGS

Finish: Painted Green or Electro-galvanized Order By: No., Size and Finish

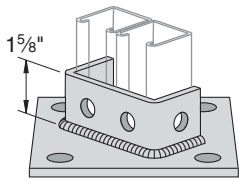

## PS 3029 – Double-Column Post Base



Use With: PS 100, PS 200 2T3, PS 210 2T3

Weight/100 pcs: 325 lbs.

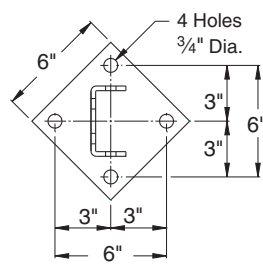

(PS 3029)

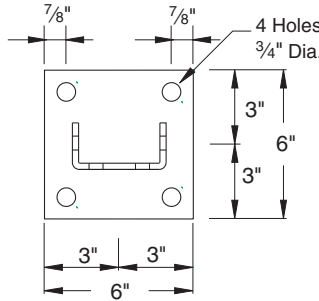

(PS 3029 SQ)

## PS 3064 – Double-Column Post Base

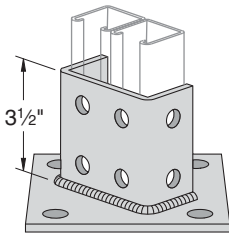

Use With: PS 100, PS 200 2T2, PS 200 2T3, PS 200 2T4 and PS 200 2T5

Weight/100 pcs: 408 lbs.

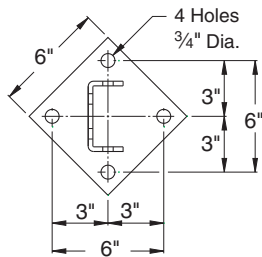

(PS 3064)

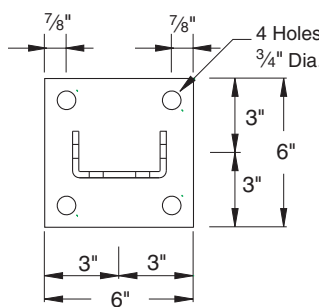

(PS 3064 SQ)

## PS 2521 – Two-Wheel Trolley

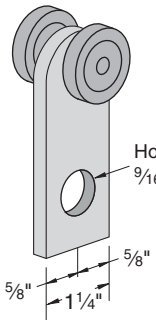

Hole  
9/16" Dia.

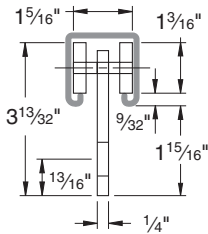

Weight/100 pcs: 46 lbs.

**Material:** Carbon Steel Wheels have stainless steel ball bearings

**Finish:** Electro-Galvanized

**Use With:** PS 200

**Load Rating:** 300 lbs.

FPM	RPM	Design Load In PS 200 Lbs
180	600	150
90	300	225
30	100	437

## PS 2528 – Trolley Beam Standard Support

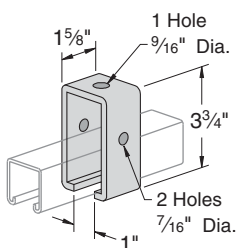

Use With: PS 200, PS 210

Load Rating: 600 lbs.

Weight/100 pcs: 102 lbs.

## PS 2528 1 – Trolley Beam Heavy Support and Track Joinder

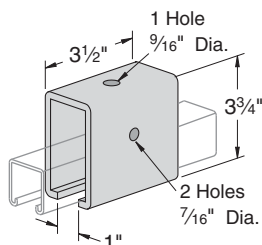

Use With: PS 200, PS 210

Load Rating: 2,500 lbs.

Weight/100 pcs: 220 lbs.

## PS 2524 – Two-Bearing Light Duty Trolley

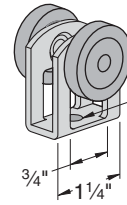

Load Rating: 50 lbs.

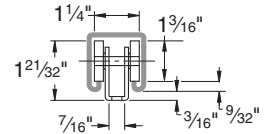

Weight/100 pcs: 21 lbs.

## PS 2525 – Four-Bearing Light Duty Trolley

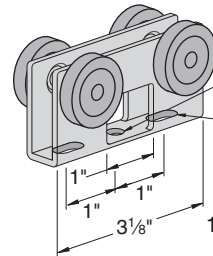

Load Rating: 100 lbs.

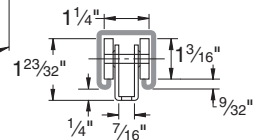

Weight/100 pcs: 55 lbs.

## PS 2522 – Four-Wheel Trolley

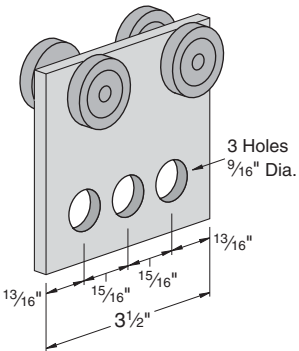

**Material:**

Carbon Steel Wheels have stainless steel ball bearings

**Finish:** Electro-Galvanized

**Use With:** PS 200

**Load Rating:** 600 lbs.

FPM	RPM	Design Load In PS 200 Lbs
180	600	300
90	300	450
30	100	600

Weight/100 pcs: 110 lbs.