

Installation Instructions

PHOTOSWITCH® Bulletin 45FSL General Purpose Fiber Optic Sensors

IMPORTANT: SAVE THESE INSTRUCTIONS FOR FUTURE USE.



Product Description

The 45FSL is a DIN rail mountable fiber optic photoelectric sensor with sophisticated part detection capabilities. Possible modes of sensing include transmitted beam, diffuse and retroreflective, allowing the 45FSL to be used in a variety of complex applications.

Summary of 45FSL Features

- **High-speed response**—30µs
- **High-intensity LEDs**—penetrate dusty environments for reliable detection of targets
- **Dual LED indicators**
- Output (orange), stability (green)
- **Red or white source LEDs**
- **Selectable 40ms off delay output timer**—“Pulse stretcher” useful in high speed applications when the output pulse must be lengthened to allow time for the machine logic to respond.
- **DIN rail mountable**—for installation convenience, a steel bracket is supplied for specific mounting requirements
- **“Power-Bus” option**—interface which allows user to jumper power on several DIN rail mounted units to reduce unnecessary wiring
- **Cross-talk protection**—prevents cross-talk between 4 or 8 sensors
- **Short circuit, reverse polarity, false pulse and transient noise protection**

45FSL photoelectric sensors are designed for use with glass or plastic fiber optic cables up to 2.2mm diameter. An adaptor is supplied with the sensor for use with 1.25mm diameter plastic fiber optic cables. No tools are required to attach or remove fiber optic cables.

Accessories

- Mounting bracket: Quantity 1
- Instruction manual: Quantity 1
- Fiber adaptor: Quantity 1

General Specifications

Model	NPN Type	45FSL-2LGE	45FSL-5LGE	45FSL-2LVE	45FSL-5LVE
	PNP Type	45FSL-2LHE	45FSL-5LHE	45FSL-2LWE	45FSL-5LWE
Light Source		Red LED	White LED	Red LED	White LED
(Wave Length)		(660nm)	—	(660nm)	—
Response Time		250µs or 500µs		30µs	
Current Consumption		NPN: 35ma/PNP: 40ma		35ma max	
Power Supply		12 to 24V DC ± 10% Ripple 10% or less			
Range		Depends on Fiber			
Output Mode		Open Collector NPN Rated: 100ma @ 30V DC Max, <1V Residual PNP Rated: 100ma @ 30V DC Max, <1V Residual			
Stability Output		Open Collector NPN Rated: 100ma @ 30V DC Max, <1V Residual PNP Rated: 100ma @ 30V DC Max, <1V Residual			
Operation Mode		Light on/dark on selectable			
Output Timer		Off delay/On delay selectable Delay time: 40ms fixed			
Indicators		Orange LED = Output, Green LED = Stability			
Interference Protection		Yes			
Short Circuit Protection		Yes			
Features		Power bus for easy wireless power distribution			
Material		Polycarbonate			
Wiring		Cable 2m (6.5ft) or pin pico QD connector or PB QD connector			
Operating Temperature		-25°C to +55°C (-13°F to 131°F)			
Operating Humidity		35% to 85% RH			
Operating Environment		NEMA 1, IP 40			
Vibration		10-55Hz, 1mm amplitude, meets or exceeds IEC 60947-5-2			
Shock		10g, 3 directions, 3 times			
Approvals		CE marked for all applicable directives			

User Interface

The user interface contains a light/dark operate switch, output timer selector switch, interference protection switch, 8-turn sensitivity adjustment knob with indication, and output LED indicators for configuring and viewing the sensor's operation and status. A more complete description of each item is described below.

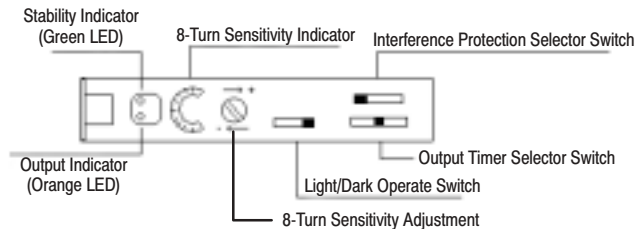

Sensor Selection

Operating Voltage	Current Consumption	Output Characteristics			Response Time	LED	Catalog Number			
		Type	Max Load Current	Max Leakage Current			Cable	Pico	Power Bus (QD required)	
12-24V DC +/- 10%	40ma or Less	PNP	Output: 100ma Stability: 50ma	0.5ma	Selectable 250µs or 500µs	Red	45FSL-2LHE-A2	45FSL-2LHE-P4	45FSL-2LHE-C4 ①	
		White				45FSL-5LHE-A2	45FSL-5LHE-P4	45FSL-5LHE-C4 ①		
	35ma or Less	NPN				Red	45FSL-2LGE-A2	45FSL-2LGE-P4	45FSL-2LGE-C4 ①	
		White				45FSL-5LGE-A2	45FSL-5LGE-P4	45FSL-5LGE-C4 ①		
	40ma or Less	PNP				30µs	Red	45FSL-2LWE-A2	45FSL-2LWE-P4	45FSL-2LWE-C4 ①
		White			45FSL-5LWE-A2		45FSL-5LWE-P4	45FSL-5LWE-C4 ①		
	35ma or Less	NPN			Red		45FSL-2LVE-A2	45FSL-2LVE-P4	45FSL-2LVE-C4 ①	
		White			45FSL-5LVE-A2		45FSL-5LVE-P4	45FSL-5LVE-C4 ①		

① PowerBus master/4 conductor QD = 45F-A4C-A2
PowerBus slave/2 conductor QD = 45F-A2C-A2

Output and Stability Indicators

Two LEDs (green and orange) indicate a variety of conditions to facilitate set-up and troubleshooting. The function of each is described in the table below. Relevant output and stability data are also shown.

LED	State	Condition
Green	OFF	Unstable light signal
	ON Flashing	Stable light signal 4 consecutive unstable light levels
Orange	OFF	Output OFF
	ON	Output ON

Stability Output is an output feature provided by the 45FSL sensor which monitors any changes or reduction of reflected light levels during operation. Reflected light levels must reach 120% of the threshold required for normal operation to achieve a "Stability Output." If the sensor detects light levels less than 120% of threshold 4 consecutive times then the green LED starts flashing and remains flashing until a stable light level is achieved (120%) (see illustration below).

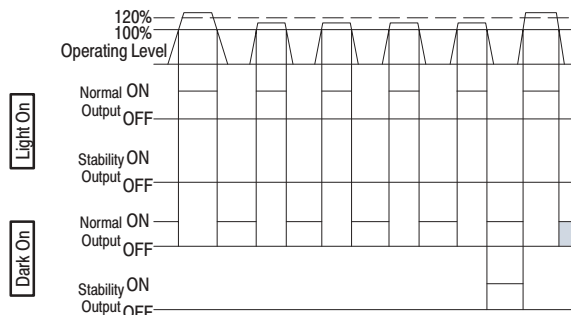

Output Timer Selector Switch

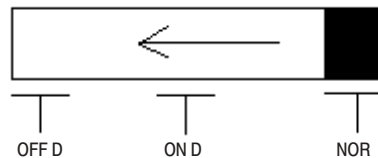

NOR: Provides normal on/off output switching

ON D: Provides output on delay (40ms)

OFF D: Provides output off delay (40ms)

8-Turn Sensitivity Adjustment

An 8-turn sensitivity adjustment (potentiometer) is built into the sensor's user interface for accuracy in detecting very small objects or differentiating between colors.

Diffuse Set Up—Light Operate Mode

With target in position, turn sensitivity adjustment clockwise until orange LED turns on (point A).

With no target in position the green and orange LEDs should be off. Otherwise turn the sensitivity adjustment clockwise to max or until orange LED turns on. If orange LED turns on, then turn sensitivity adjustment counterclockwise until orange LED turns off (point B).

Set sensitivity adjustment midway between points A and B. Confirm sensor operation.

Transmitted Beam Set Up—Dark Operate Mode

With no target present, turn the sensitivity adjustment clockwise to max until the orange and green LEDs turn on (point A).

Green/orange LEDs should turn off. Otherwise turn sensitivity adjustment counterclockwise until the green/orange LEDs turn off. Turn sensitivity adjustment counterclockwise additional one quarter turn and confirm sensor operation.

Light/Dark Operate Switch

LIGHT or DARK operation modes may be chosen by changing mode switch.

4/8 Channel Cross-Talk Protection

The 45FSL is equipped to prevent cross-talk to up to 4 ganged sensors providing a 250 μ s response time or up to 8 ganged sensors maintaining a 500 μ s response time. Each sensor communicates through 2 small optic windows that transmit and receive coded signals (see below).

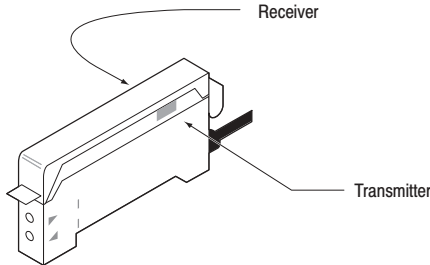

Ganging up to 4 Sensors on DIN Rail

- Mount and align up to 4 sensors on DIN rail
- Move cross-talk selector switch to "4" on all sensors. (Sensors will not function if cross-talk selector switch is set to "8" on any sensor.)
- Install fiber optic cables
- Power up sensor

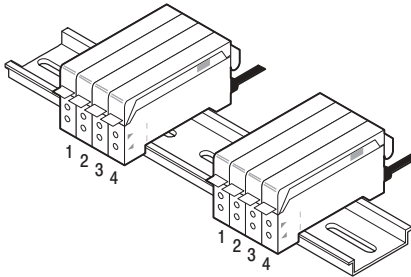

Ganging 4 to 8 Sensors on DIN Rail

- Mount and align up to 8 sensors on DIN rail.
- Move cross-talk selector switch to "8" on all sensors. (Sensors will not function if cross-talk selector switch is set to "4" on any sensor.)
- Install fiber optic cables
- Power up sensor

Mounting the Sensor

How to Attach Sensor to DIN Rail

Attach front hook of the photoelectric sensor onto rail (or mounting bracket) and press rear end of sensor down until unit snaps into place.

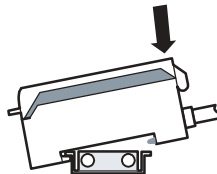

How to Detach Sensor from DIN Rail

Pushing the sensor unit forward, pull up on the front of the sensor until the front hook is detached. Remove sensor.

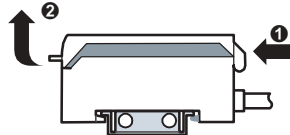

Side Mounting Sensor with Bracket

Fasten mounting bracket assembly using M3 screws. Tightening torque is 0.8Nm max. Attach front hook of the photoelectric sensor onto mounting bracket and press rear end of sensor down until unit snaps into place.

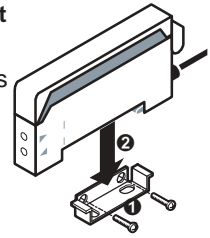

Wiring the Sensor

Choice of Power Bus, 2m (6.5ft) cable, or 4 pin QD connector are provided for wiring the 45FSL Series sensors. On the pico QD models Rockwell Automation/Allen-Bradley recommends the use of the 889 Series cordsets and patchcords (i.e., 889P-F4AB-2). Standard 2m (6.5ft) cable lengths are provided with flying leads for hard wiring. Hard wiring color coding and pin assignment for QD connectors are as specified below.

Designation	Lead Color 2m (6.5ft) Cable	Pin Assignment 4 Pin Pico QD
Termination		
V+	Brown	1
0V	Blue	3
Output	Black	4
Stability Output	Orange	2

The **Power Bus** option utilizes quick disconnect cordsets which are prewired with up to four conductors. When ganging sensors (up to 16 units maximum) using the Power Bus connection system, select either a 4-wire cable (plus/minus power output and stability output) or a 3-wire cable (plus/minus power output) for the first control. For the additional controls in a system, select either a 2-wire cable (output and stability output) or a 1-wire cable (output only) to complete the system.

Wiring Diagram/Power Bus Option

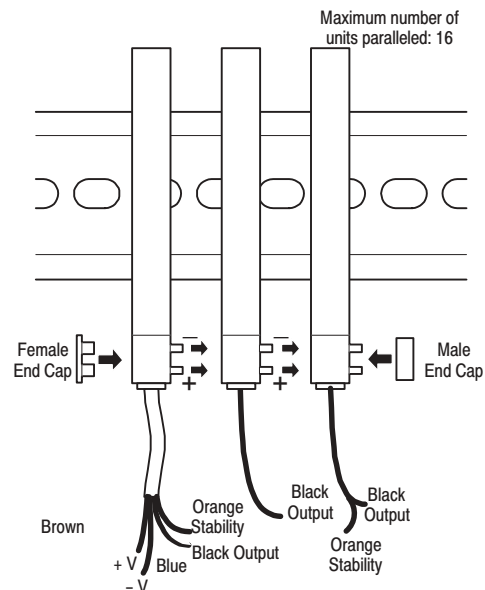

Wiring Diagrams

Cable

NPN Output

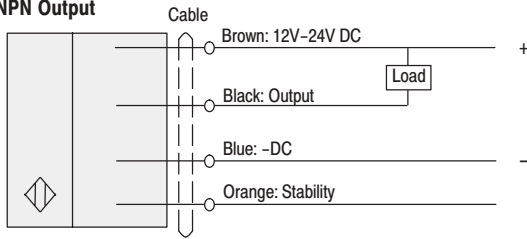

PNP Output

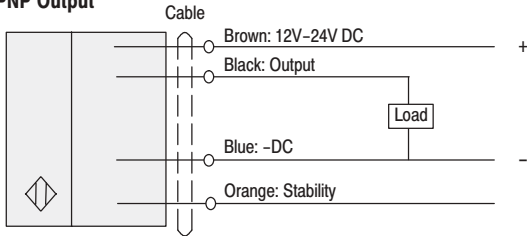

Quick-Disconnect

NPN Output

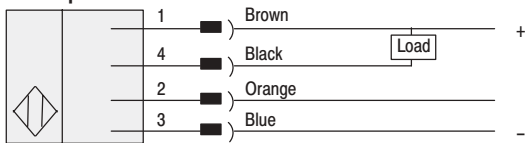

PNP Output

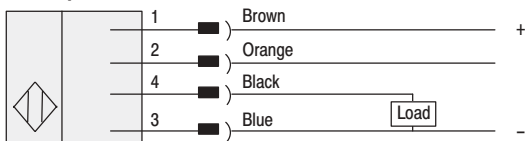

Dimensions

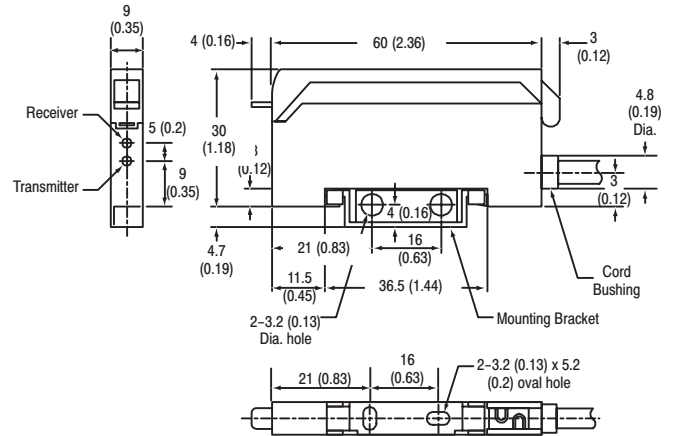

Replacement Parts

- Plastic Sensor Cover : PSC1
- Fiber Optic Cable (Diffuse) : 99-94
- Fiber Optic Cable (Transmitted Beam) : 99-90
- Pico QD Cordset : 889P-F4AB-2
- Power Bus QD Connectors:
 - 2 Conductor = 45F-A2C-A2
 - 4 Conductor = 45F-A4C-A2
- Power Bus End Caps:
 - Male Cap = 45F-AMC
 - Female Cap = 45F-AFC