

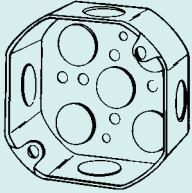

OB/SB-1

4" Octagon Boxes

With Conduit Knockouts



40-1/2
1-1/2" Deep

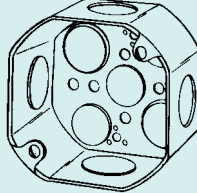

40-3/4
1-1/2" Deep

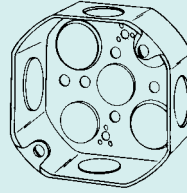

40-SPL
1-1/2" Deep

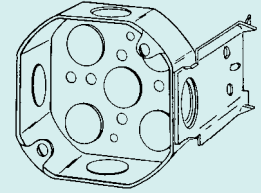

40JB-1/2
1-1/2" Deep
JB bracket set flush,
gauging notches 3/8" & 1/2"

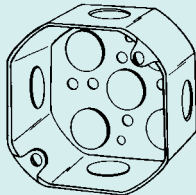

40D-1/2
2-1/8" Deep

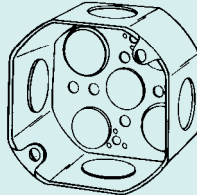

40D-3/4
2-1/8" Deep

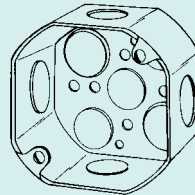

40D-SPL
2-1/8" Deep

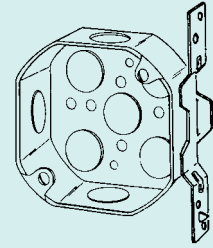

40VB-1/2
1-1/2" Deep
Vertical bracket set back 5/8"

OB/SB-1

Catalog Number (Universal No.)	Depth (inches)	Wiring Cubic Inch Capacity	Knockout Description			Wt. Lbs. Per 100	Std. Pkg.
			Sides	Ends	Bottom		
40-1/2 (54151-1/2)	1-1/2	15.5	(4)1/2"	--	(5)1/2"	52.0	25
40-3/4 (54151-3/4)	1-1/2	15.5	(4)3/4"	--	(3)1/2" (2)3/4"	52.0	25
40-SPL (54151SPL)	1-1/2	15.5	(2)1/2" (2)3/4"	--	(3)1/2" (2)3/4"	52.0	25
40JB-1/2 (54151J-1/2)	1-1/2	15.5	(4)1/2"	--	(5)1/2"	68.0	25
40D-1/2 (54171-1/2)	2-1/8	21.5	(4)1/2"	--	(5)1/2"	66.0	50
40D-3/4 (54171-3/4)	2-1/8	21.5	(4)3/4"	--	(3)1/2" (2)3/4"	66.0	25
40D-SPL (54171SPL)	2-1/8	21.5	(2)1/2" (2)3/4"	--	(3)1/2" (2)3/4"	68.0	25
40VB-1/2 (54151F-1/2)	1-1/2	15.5	(3)1/2"	--	(5)1/2"	62.0	25
SX115-40-1/2	1-1/2	15.5	(4)1/2"	--	(4)1/2"	92.0	25

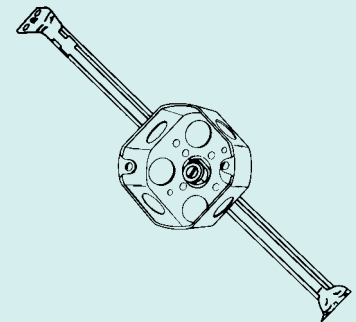

SX115-40-1/2
1-1/2" Deep
40-1/2 box on SX115 stud bar hanger
adjusts from 11-1/2" to 18-1/2"

3-1/2" Cover Hole Centerline.