

16 mm Push Buttons

Product Overview/Specifications



Bulletin 800B — 16 mm Push Buttons

- Designed to worldwide standards (UL, CSA, CE, and CCC)
- Durable materials
 - Operators are made of corrosion-proof plastic to ensure long push button life
 - Consistent coloring and illumination make these easy to identify for the life of the operator
- Ease of installation
- Ergonomic design
 - Contoured button surface
- Dependable sealing
 - IP66 and Type 4/13
 - Diaphragm seals: linear travel devices, pilot lights
 - V-seals: selector switches, high pressure sealing
 - K-seals: emergency stops, dual wiping action
- Reliable low voltage switching
 - Gold-plated snap action contacts
 - Reliable operation in applications below 24V DC, 5 mA down to 5V DC, 1 mA
- Enhanced E-stop functionality
 - Anti-tease feature standard (trigger-action)
 - EN13850 and EN 60947-5-5 compliant
 - Direct Drive mechanism (positive actuation)





Table of Contents

Product Selection this page
 Accessories..... 10-149
 Specifications..... 10-150
 Approximate
 Dimensions..... 10-151

Standards Compliance and Certifications

Certifications	UR, CSA, CCC, CE
Standards Compliance	UL 508, EN ISO 13850, EN 60947-1, EN 60947-5-1, EN 60947-5-5
Terminal Identification	EN/IEC 60947-1
RoHS Compliant	✓

Push Button & Pilot Light Operators*

Operator Type	Cat. No.			
				
	Round	Square	Rectangle	Large Square
Momentary, push button/pilot light	800B-EPA	800B-EPB	800B-EPC	800B-EPD
Maintained, push button	800B-EAA	800B-EAB	800B-EAC	800B-EAD

Note: Package Quantity = 1

* All operators are sold without a lens cap and diffuser.

Lens Cap with Diffuser§



Cat. No. 800B-ALA3



Cat. No. 800B-ALB4



Cat. No. 800B-ALC5



Cat. No. 800B-ALD6









Lens Color	Cat. No.			
	Round	Square	Rectangle	Large Square
Green	800B-ALA3	800B-ALB3	800B-ALC3	800B-ALD3
Red	800B-ALA4	800B-ALB4	800B-ALC4	800B-ALD4
Yellow	800B-ALA5	800B-ALB5	800B-ALC5	800B-ALD5
Blue	800B-ALA6	800B-ALB6	800B-ALC6	800B-ALD6
White	800B-ALA7	800B-ALB7	800B-ALC7	800B-ALD7

Note: Package Quantity = 1

§ For illuminated devices, LED bulbs are color specific. (Green LED bulb with green lens caps, red LED bulbs with red lens cap, white LED bulbs used with yellow, blue, and white lens cap.) Incandescent bulbs can be used with any lens cap color.







Selector Switch Operators*

Operator Type	2-Position Selector Switches		3-Position Selector Switches	
				
	Maintained	Return from Right	Maintained	Return from Both
Cat. No.	800B-SM2A	800B-SR2A	800B-SM3A	800B-SB3A
Operator Type	2-Position Selector Switches		3-Position Selector Switches	
				
	Keyed, Maintained	Keyed, Return from Right	Keyed, Maintained	Keyed, Return from Both
Cat. No.	800B-KM2A	800B-KR2A	800B-KM3A	800B-KB3A

Note: Package Quantity = 1

Target Table and Operator Position

Contact Block Cat. No.	Contact Block Location	Contact Type	2-Position Target Table		3-Position Target Table		
							
800B-PS11	Top	NA	—	—	—	—	—
	Bottom	N.C.	X	O	O	X	X
		N.O.	O	X	X	O	O
800B-PS22	Top	N.C.	X	O	X	X	O
		N.O.	O	X	O	O	X
	Bottom	N.C.	X	O	O	X	X
		N.O.	O	X	X	O	O
800B-PT01	Top	NA	—	—	—	—	—
	Bottom	N.C.	X	O	O	X	X
800B-PT02	Top	N.C.	X	O	X	X	O
	Bottom		X	O	O	X	X
800B-PT11	Top	N.O.	O	X	O	O	X
	Bottom	N.C.	X	O	O	X	X

Note: X = Closed/O = Open

* To illuminate a selector switch, add either an LED or incandescent bulb. All selector switches have a clear lens. Green and red LED bulbs can be used to change the selector switch color.

Emergency Stop Operators — Non-Illuminated, Twist-to-Release (Trigger Action)‡

	Description	Pkg. Quantity	Cat. No.
 Cat. No. 800B-MT	Emergency stop operator	1	800B-MT

‡ Operator is EN ISO 13850 compliant with standard N.C. contact blocks.

16 mm Push Buttons



Product Selection

Contact Block/Latch Module

	Description	Pkg. Quantity	Cat. No.
Push Button/Selector Switch			
 <i>Cat. No. 800B-PS11</i>	1 N.O./1 N.C. snap action	1	800B-PS11
 <i>Cat. No. 800B-PS22</i>	2 N.O./2 N.C. snap action	1	800B-PS22
Pilot Light			
 <i>Cat. No. 800B-PL</i>	Dummy block	1	800B-PL
Emergency Stop/Push Button/Selector Switch			
 <i>Cat. No. 800B-PT01</i>	1 N.C. slow make/break	1	800B-PT01
 <i>Cat. No. 800B-PT02</i>	2 N.C. slow make/break	1	800B-PT02
 <i>Cat. No. 800B-PT11</i>	1 N.O./1 N.C. slow make/break	1	800B-PT11

Replacement Bulbs

10

	Description	Lamp Color	Lamp Voltage	Pkg. Quantity	Cat. No.
	LED bulb*	Green	12...24V AC/DC	1	800B-N3G
			120V AC		800B-N5G
		Red	12...24V AC/DC		800B-N3R
			120V AC		800B-N5R
		White	12...24V AC/DC		800B-N3W
			120V AC		800B-N5W
	Incandescent bulb*	Clear	6V AC/DC	800B-N1C	
			12V AC/DC	800B-N2C	
			24V AC/DC	800B-N3C	

* Not available in 6V AC/DC.

⊛ Not available in 120V AC.



Accessories

	Description	Pkg. Quantity	Cat. No.
 Cat. No. 800B-ARP	Replacement mounting ring	10	800B-ARP
 Cat. No. 800B-AW2	Mounting ring wrench	1	800B-AW2
 Cat. No. 800B-ALR1	Bulb removal tool	1	800B-ALR1
 Cat. No. 800B-ALR2	Lens removal tool	1	800B-ALR2
 Cat. No. 800B-ALW1	Locking washer (anti-rotation)	10	800B-ALW1
 Cat. No. 800B-ATK	Stab connector (insulated)	10	800B-ATK
 Cat. No. 800B-N2	Hole plug	10	800B-N2
 Cat. No. 800B-AK1	Replacement key	1	800B-AK1
 Cat. No. 800B-APCB	Printed circuit board pin socket	10	800B-APCB
 Cat. No. 800B-15YE112	Emergency stop legend plate	1	800B-15YE112
 Cat. No. 800B-ABZB	Square bezel	10	800B-ABZB
 Cat. No. 800B-ABZC	Rectangle bezel	10	800B-ABZC
 Cat. No. 800B-ABZD	Large square bezel	10	800B-ABZD

10

Bulletin 800B
16 mm Push Buttons
Specifications

Specifications

Mechanical Ratings			
Vibration (assembled to panel)	Tested at 10...2000 Hz, 1.52 mm displacement (peak-to-peak) max./10 G max. for 6 hr duration, no damage		
Shock	Tested at 1/2 cycle sine wave for 11 ms; no damage at 100 G		
Degree of protection*	IP66, Type 4/4X/13		
Mechanical durability per EN 60947-5-1 (Annex C)	2 000 000 Cycles	Push buttons – momentary	
	1 000 000 Cycles	Push buttons – maintained	
	250 000 Cycles	Selector switch	
	200 000 Cycles	Key selector switch	
	200 000 Cycles	Twist-to-release E-stop	
Operating forces (typical with one contact block)	Extended = 5...8 N E-stop = 14...16 N		
Operating torque (typical application with one contact block)	Selector switch = 0.06 N•m (0.5 lb•in)		
Mounting torque	1.1 N•m (10 lb•in)		
Environmental			
Temperature range (operating)	-25...+55 °C (-13...+131 °F)		
Temperature range (short term storage)	-40...+70 °C (-40...+158 °F)		
Humidity	50...95% RH from 25...60 °C (77...140 °F)		
Mechanical Ratings — Contact Blocks			
Vibration (assembled to panel)	Tested at 10...2000 Hz, 1.52 mm displacement (peak-to-peak) max./10 G max. 6 hr		
Shock	Tested at 1/2 cycle sine wave for 11 ms and no damage at 100 G max.		
Contact durability	200 000 cycles (Cat. No. 800B-PS_)		
Contact operation	N.O. / N.C.	Snap action	
	N.C.	Slow make/break positive opening	
	N.O.	Slow make/break	
Push button travel to change electrical state	1.4 mm (0.06 in.)		
Operating forces (typical)	1 contact block = 3 N 2 contact blocks = 6 N		
Electrical Ratings			
Standard contact block ratings	AC 15, B300, 1.5 A/240V AC, 3 A/120V AC DC 13, R300, 0.1 A/250V DC, 0.22 A/125V DC		
LED Module ratings	Nominal Voltage	Current	Frequency
	12...24V AC	12 mA	50/60 Hz
	12...24V DC 120V AC	12 mA 9 mA	DC 50/60 Hz
Thermal current	$I_{th} = 5 \text{ A (AC)}, I_{th} = 1 \text{ A (DC)}$		
Insulation voltage (U_i)	300V		
Stab termination	2.8 X 0.5 mm		
Dielectric strength (minimum)	1500V 1 min.		
External short circuit protection – standard blocks	6 A type gL/gG cartridge fuse to EN 60269-2-1 or gN (Class J to UL 248-8 or Class C to UL 248-4)		
Electrical shock protection	Finger-safe conforming to IP2X		
Illumination			
LED Dominant wavelength	Green	525 nm	
	Red	624 nm	
	White	—	
LED Luminous intensity	Green	500 mcd	
	Red	400 mcd	
	White	1000 mcd	
Incandescent maximum wattage	1.2 W		
Materials			
Springs	Stainless steel and gold-plated, high-carbon steel		
Electrical contacts	Gold-plated silver		
Stab terminals	Phosphor bronze with gold or nickel plating		
Lenses	Polycarbonate		

Approximate Dimensions

Round

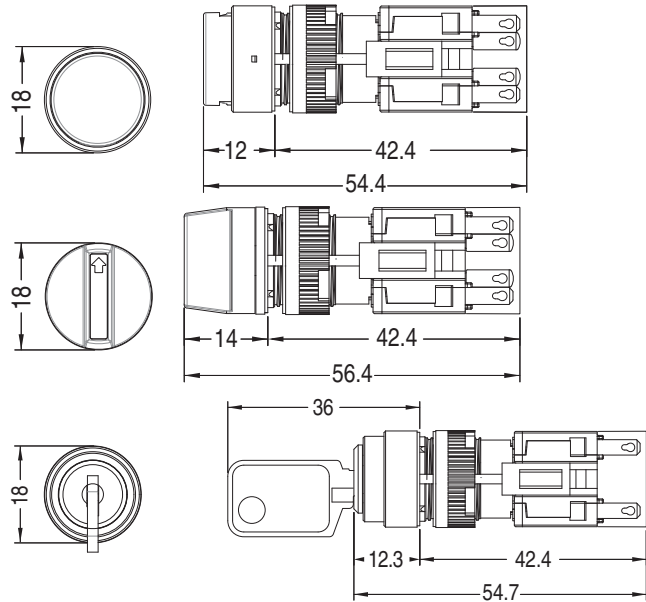

Hole Patterns

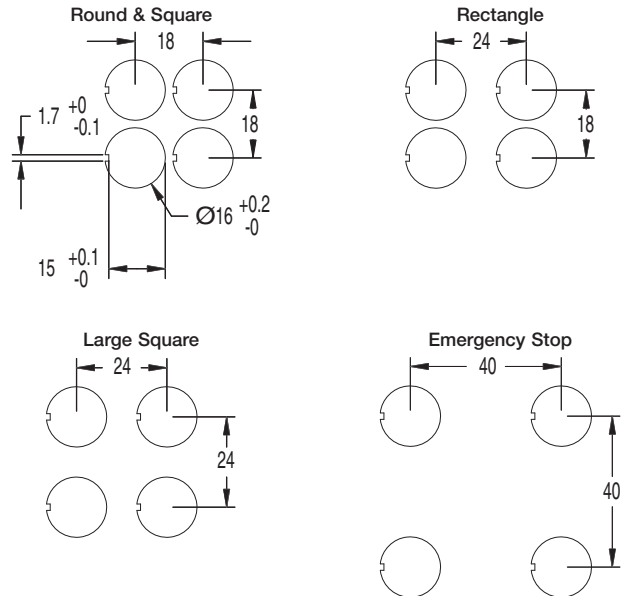

Square

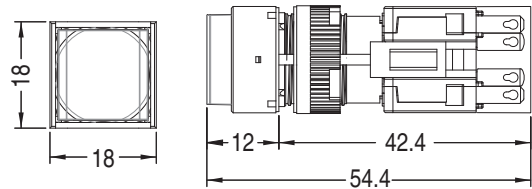

Printed Circuit Board Pin Socket

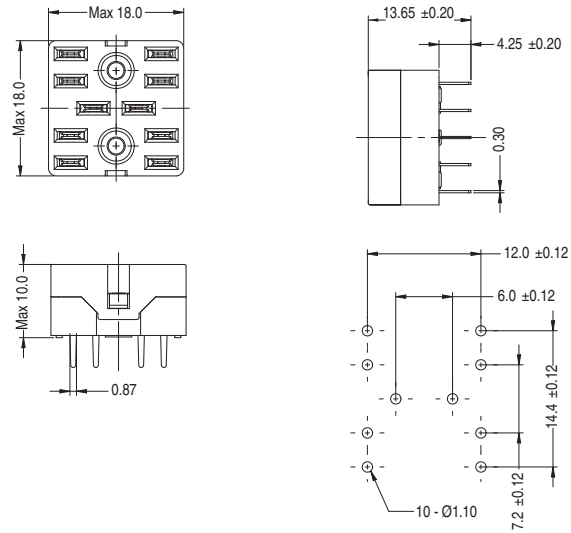

Rectangle

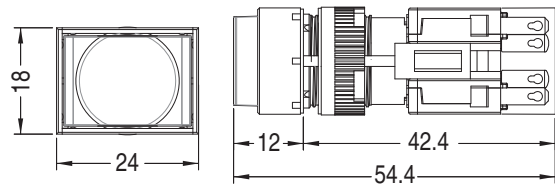

Large Square

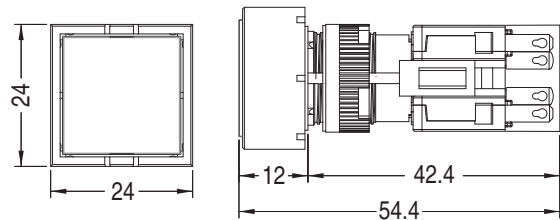

Emergency Stop

