

# B371C

## 6" Slope Double Wall IC Housing

LAMP WATTAGE: (1) MAXIMUM 75W R/PAR30, 60W A19, 65W BR30

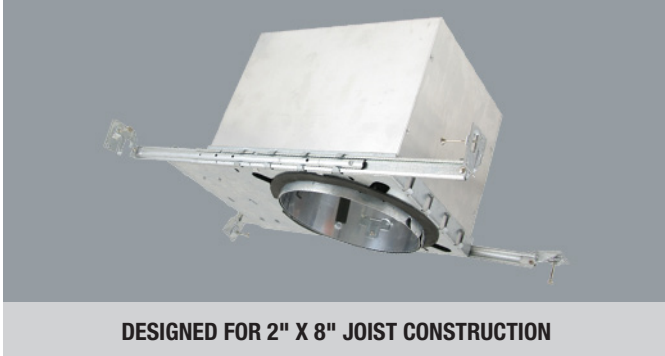

DESIGNED FOR 2" X 8" JOIST CONSTRUCTION

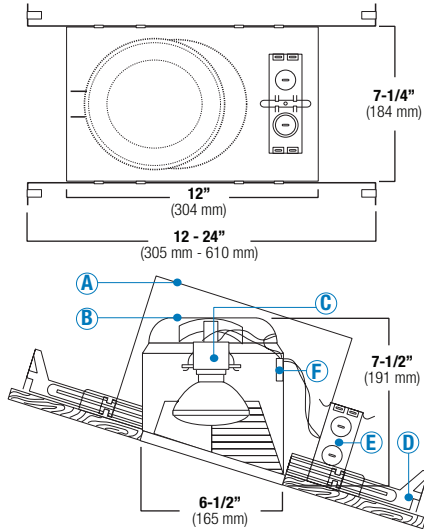

ITEM SELECTOR: (Please check the boxes below for the option desired)

TYPE	AIR-SHUT	TRIM TYPE	BAFFLE	REFLECTOR	TRIM/RING	
B371C	<input type="checkbox"/> AT	<input type="checkbox"/> B391 <input type="checkbox"/> B392 <input type="checkbox"/> B602 <input type="checkbox"/> B646 <input type="checkbox"/> B394 <input type="checkbox"/> B395 <input type="checkbox"/> B663 <input type="checkbox"/> B673	<input type="checkbox"/> B601 <input type="checkbox"/> B601L <input type="checkbox"/> B605 <input type="checkbox"/> B605L	<input type="checkbox"/> W <input type="checkbox"/> P <input type="checkbox"/> SN <input type="checkbox"/> CP <input type="checkbox"/> BZ	<input type="checkbox"/> CL <input type="checkbox"/> RG <input type="checkbox"/> W <input type="checkbox"/> MB <input type="checkbox"/> BZ <input type="checkbox"/> CP <input type="checkbox"/> SN <input type="checkbox"/> SHZ	<input type="checkbox"/> WH <input type="checkbox"/> BK <input type="checkbox"/> SN <input type="checkbox"/> CP <input type="checkbox"/> CH <input type="checkbox"/> PB <input type="checkbox"/> BZ

### Specifications:

B371C

AIR-SHUT	OPTION	TRIM TYPE	BAFFLE	REFLECTOR	TRIM/RING	GLASS
----------	--------	-----------	--------	-----------	-----------	-------

Sample of Catalog Number: B371C-AT-B391-W-WH

\*For custom baffle, reflector, trim ring, glass color and lens options, please consult factory.

Catalog Number:

Project Name:

Type:

Note:



### DESCRIPTION

New construction, thermally protected, IC rated specification grade recessed housing. Designed to meet restricted Air Flow requirements. Designed for sloped ceiling applications where the ceiling pitch ranges from 2/12 to 6/12. Accommodates up to 75W PAR30 or R30 lamps. Furnished with preinstalled adjustable bar hangers. Junction box is provided with four 1/2" KOs, one 3/4" KO and four Romex knockouts with strain relief.

### SPECIFICATION

**A. OUTER HOUSING** - Die formed aluminum construction for maximum heat dissipating air chamber on top of the housing. Junction box could be accessed from inside and outside housing.

**B. INNER HOUSING** - Die-formed all aluminum construction for maximum heat dissipation and rust protection. Adjusts vertically in plaster frame to accommodate 1/2" to 1" ceiling.

**C. SOCKET** - Medium base screw shell porcelain socket preinstalled on a mounting bracket is specially designed to swivel and rotate so the lamp could be aligned properly. The lamp will aim straight down regardless of the ceiling pitch.

**D. BAR HANGERS** - Preinstalled bar hangers allow housing to be positioned and locked at any point within a 24" joist span and can be shortened for 12" joists. Integral bar hanger nailers are designed to be hammered directly into the joist without additional nails or screws and makes installation fast and accurate. Bar hangers can fit onto T-Bar spline with additional slots and holes for special mounting methods if necessary.

**E. JUNCTION BOX** - ETL listed for through-branch circuit wiring and has four 1/2" KOs, one 3/4" KO and four Romex knockouts with true pry-out slots and strain clamps.

**F. THERMAL PROTECTION** - Standard thermal protection device guards against improper installation, overlampping and misuse of insulation material.

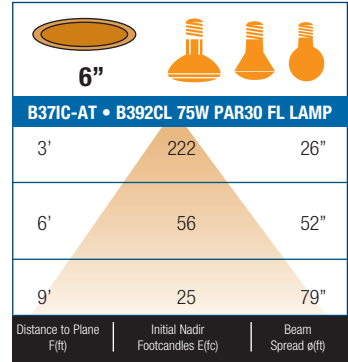

BEAM DIA. MEASURED AT 50% OF NADIR F.C.

### FEATURES

- Thermally Protected IC housing.
- The socket bracket is specially designed to swivel and rotate so the lamp could be aligned properly. The lamp will aim straight down regardless of the ceiling pitch.
- Adjustable socket bracket with a slope indicator provides consistent lamp alignment and setup.
- Wire through junction box.
- Preinstalled adjustable bar hanger.
- Dependable, favorable design and effortless installation.
- 7-1/2" height allows use in 2" x 8" joist construction.
- Preinstalled socket cap provides electrical contact protection against dust, paint and over spray.

### OPTIONS

#### AIR-SHUT

- Gasket to prevent air flow from heated or air conditioned spaces.
- Meets all national air flow requirements.

#### ETL AND C-ETL LISTED

- For Damp location
- For Feed-through wiring
- For Direct contact with insulation

BAFFLE	REFLECTOR	TRIM/RING
W White	CL Chrome	WH White
P Black	RG Gold	BK Black
SN Satin Nickel	W White	SN Satin Nickel
CP Copper	MB Black	CP Copper
BZ Bronze	BZ Bronze	CH Chrome
	CP Copper	PB Polish Brass
	SN Satin Nickel	BZ Bronze
	SHZ Satin Haze	



Submission form is available @ [www.iuseelite.com](http://www.iuseelite.com)  
Tel: 323-888-1973 • Fax: 323-888-1977

Specifications and Dimensions subject to change without notice.

REV: ELITE LIGHTING-SPEC-06-29-2011

# 6" Slope Ceiling Incandescent Trims

(LAMP WATTAGE: (1) MAXIMUM 75W R/PAR30, 60W A19, 65W BR30)

Catalog Number:

Project Name:

Type:

Note:



**B391CP-CP**  
METAL STEPPED BAFFLE R30/PAR30



**BAFFLE FINISH:**  
W, P, SN, CP, BZ

**TRIM/RING FINISH:**  
WH, BK, SN, CP, CH,  
PB, BZ

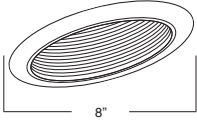

**B394P-WH**  
PAR38/R40 STEPPED BAFFLE

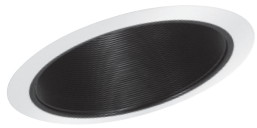

**BAFFLE FINISH:**  
W, P, SN, CP, BZ

**TRIM/RING FINISH:**  
WH, BK, SN, CP, CH,  
PB, BZ

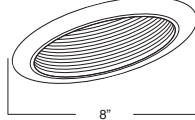

**B392RG-WH**  
R30/PAR30 REFLECTOR



**REFLECTOR FINISH:**  
CL, RG, W, MB, CP,  
SN, BZ

**TRIM/RING FINISH:**  
WH, BK, SN, CP, CH,  
PB, BZ

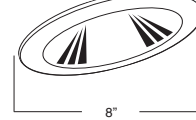

**B395CP-WH**  
R38/PAR40 REFLECTOR



**REFLECTOR FINISH:**  
CL, RG, W, MB, CP,  
SN, BZ

**TRIM/RING FINISH:**  
WH, BK, SN, CP, CH,  
PB, BZ

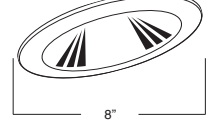

**B602SN**  
EYEBALL



**TRIM/RING FINISH:**  
WH, BK, SN, CP, CH,  
PB, BZ

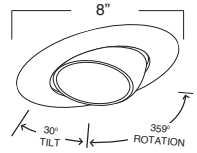

**B646P-WH**  
EYEBALL WITH BAFFLE



**BAFFLE FINISH:**  
W, P

**TRIM/RING FINISH:**  
WH

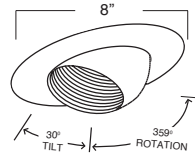

**B663PB**  
PAR30 GIMBAL RING



**TRIM/RING FINISH:**  
WH, BK, SN, CP, CH,  
PB, BZ

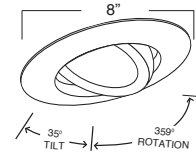

**B673P-OV**  
PAR30 BAFFLE W/ GIMBAL RING

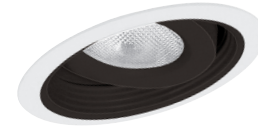

**BAFFLE FINISH:**  
W, P, SN, CP

**TRIM/RING FINISH:**  
WH

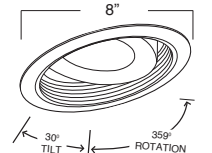

**B601CP**  
METAL ALBALITE LENS



**LENS:**  
ALBALITE

**TRIM/RING FINISH:**  
WH, BK, SN, CP, CH,  
PB, BZ

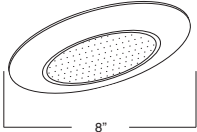

**B601L**  
PLASTIC ALBALITE LENS



**LENS:**  
ALBALITE

**TRIM/RING FINISH:**  
WHITE PLASTIC

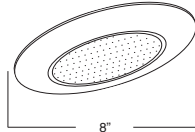

**B605PB**  
METAL FRESNEL LENS

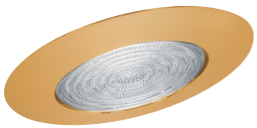

**LENS:**  
FRESNEL

**TRIM/RING FINISH:**  
WH, BK, SN, CP, CH,  
PB, BZ

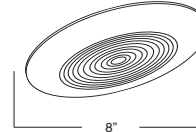

**B605L**  
PLASTIC FRESNEL LENS



**LENS:**  
FRESNEL

**TRIM/RING FINISH:**  
WHITE PLASTIC

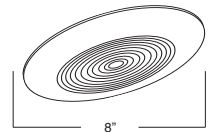

BAFFLE		REFLECTOR		TRIM RING	
<b>W</b>	White	<b>CL</b>	Chrome	<b>WH</b>	White
<b>P</b>	Black	<b>RG</b>	Gold	<b>BK</b>	Black
<b>SN</b>	Satin Nickel	<b>W</b>	White	<b>SN</b>	Satin Nickel
<b>CP</b>	Copper	<b>MB</b>	Black	<b>CP</b>	Copper
<b>BZ</b>	Bronze	<b>CP</b>	Copper	<b>CH</b>	Chrome
		<b>SN</b>	Satin Nickel	<b>PB</b>	Polish Brass
				<b>BZ</b>	Bronze

\*For custom baffle, reflector, trim ring, glass color and lens options, please consult factory.