

► Model 300GC

SelecTone® Amplified Speaker



Federal Signal's Model 300GC SelecTone® Amplified Speaker is designed to produce crisp tones, clear tones, digital voice messages and live public address in harsh environments with high ambient noise levels.

The internal circuitry, tone module, and gain control are contained in a housing constructed of die-cast aluminum. All surfaces are sealed with powder-coat paint. Dust- and moisture-proof gaskets provide protection from the elements.

SelecTone Amplified Speakers are used individually or as part of a plant-wide emergency notification system. The Model UTM Universal Tone Module, with 32 tones, or the TM33 Custom Tone Module is plugged into a single SelecTone Amplified Speaker for stand-alone use or into a SelecTone Command Unit for plant-wide signaling.

For plant-wide signaling, a Connector Kit is installed into each SelecTone Amplified Speaker and wired to a central controller. SelecTone Command Units and CommCenter® Digital Message Centers broadcast tones, voice messages, melodies and live public address to an unlimited number of SelecTone Amplified Speakers.

Typical applications for SelecTone include emergency warning, plant evacuation, start and dismissal, public address, and process control signaling.

FEATURES

- Available in 24VAC/DC, 120VAC and 240VAC
- Built-in gain control, adjustable between 0 dBa to 110 dBa @ 10' (0 dBa to 120 dBa @ 1m)
- Cast copper free aluminum housing, spun aluminum projector
- Indoor or outdoor use
- Type 3R, IP54 enclosure
- Digital signal amplification
- Fused input & output
- UL 1480 and CSFM Approved
- UL and cUL Listed

MODEL	VOLTAGE	OPERATING CURRENT	STANDBY CURRENT*	DECIBELS	
				10'	1M
300GC-024	24VDC	1.0 amps	50 mA	110	120
	24VAC 50/60Hz	1.0 amps	100 mA	110	120
300GC-120	120VAC 50/60Hz	0.25 amps	30 mA	110	120
300GC-240	240VAC 50/60Hz	0.15 amps	15 mA	110	120

*When used as a powered loud speaker

SelecTone® Amplified Speaker (300GC)

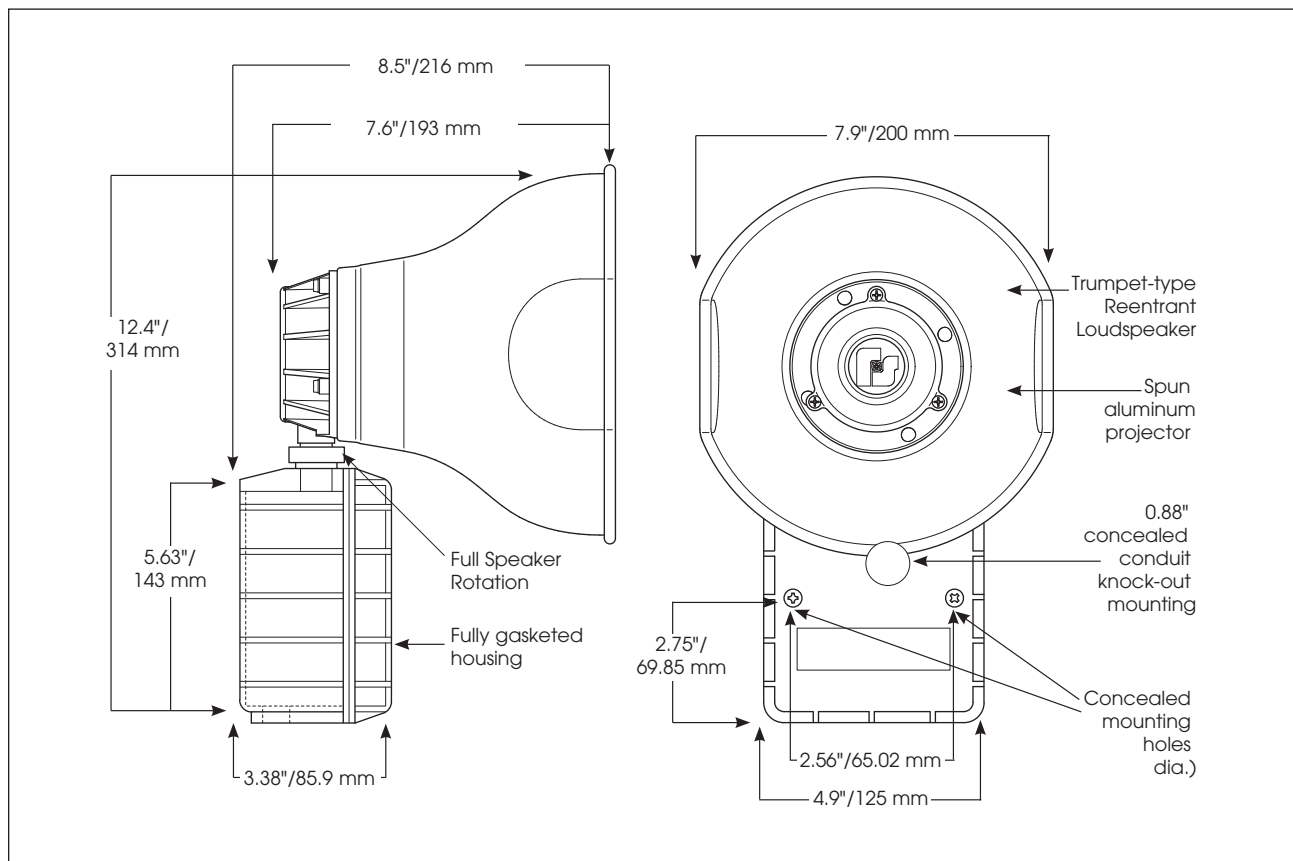

SPECIFICATIONS

Operating Temperature:	-67°F to 150°F	-55°C to 66°C
Rated Power		15 watt
Net Weight:		
24VAC/DC	5.5 lbs	2.5 kg
120/240VAC	5.5 lbs	2.5 kg
Shipping Weight:		
24VAC/DC	6.7 lbs	3.0 kg
120/240VAC	6.7 lbs	3.0 kg
Height:	12.4"	314.0 mm
Width:	7.9"	200.0 mm
Depth:	8.5"	216.0 mm

REPLACEMENT PARTS

Description	Part Number
Amplifier Assembly, 24VAC/DC	K2005502A-04
Transformer, 120VAC	K120857A
Transformer, 240VAC	K120858A
Voice Coil, Series C	K8593035A
Speaker Assembly	K8593082A

HOW TO ORDER

300CG	–	024
TYPE		VOLTAGE
300CG		024 (24VAC/DC)
		120 (120VAC)
		240 (240VAC)

Specify Tone Module:

- For stand alone operation
- UTM** – Universal Tone Module
(Reference page 199 for list of tones)
- TM33** – Custom Tone Module
(Reference page 201 for list of tones)

Specify Connector Kit:

(sold separately) for use in systems
Call factory for system design assistance.
(Reference page 202 for Connector Kits)

- AM25CK** – 25 Vrms, 1 Vrms
- AM70CK** – 70 Vrms, 1 Vrms
- 300CK** – 10 Vrms, 1 Vrms
- T-300CK** – 2.7 Vrms, 1 Vrms
- E-300CK** – 1 Vrms, 1 Vrms