

Eclipse Series Digital Panel Meters

Models: 5770X-40X - DC Volts
5770X-41X - AC Volts
5770X-42X - DC Amps
5770X-43X - AC Amps
5770X-44X - 5A AC
5770X-45X - Linear Process Signals

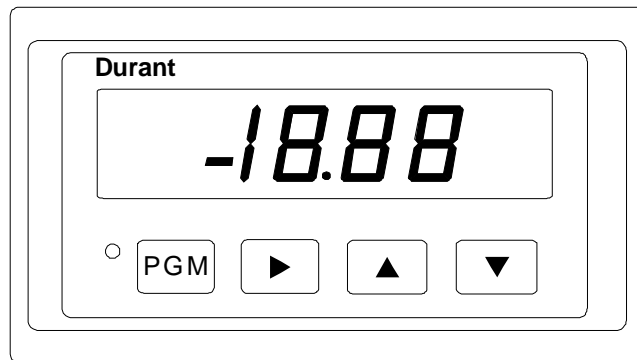

Table of Contents

1	Introduction
1	Description
3	Mounting
4	Wiring
9	Programming
14	Run Mode
14	Diagnostics
17	Specifications

Durant®

Visit our Web Site
at www.durant.com



INTRODUCTION/ DESCRIPTION

This manual describes the installation of Durant models 5770X-40X through 5770X-45X digital panel meters (DPM's). This manual steps through the installation of the DPM in a logical order. First is a brief description of the base unit and the plug-in option boards. Next comes mounting information, wiring diagrams (including DIP switch settings), and programming instructions. This is followed by run mode instructions that the operator may need. Finally, this manual contains diagnostic test and calibration information and specifications.

DESCRIPTION

Base Unit

The DPM converts a linear, analog voltage or current input signal into a digital read-out for the observer. The display can be scaled to read out in units other than volts or amps. For instance, a pressure sensor may put out a 4-20 mA signal over a range of 0-100 PSI. In this case, the DPM could be scaled to show 0 at 4 mA in, and 100 at 20 mA in. The range of the display is full four digits, with sign (-9999 to 9999). In addition to the present reading, the unit will also display the captured maximum and minimum readings. The base unit contains slots for mounting optional, plug-in circuit boards for relay output, analog retransmission, and serial communication capabilities.

Relay Output Option Board

The optional relay board contains two form C (normally open and normally closed contacts) relays, called relay 1 and relay 2. Each relay has an adjustable high and low setpoint. The relays act as alarms by turning on when the value on the display is greater than the high setpoint OR is less than the low setpoint. If the low setpoint is greater than the high setpoint, the relay turns on when the value on the display meets both conditions; less than the low setpoint AND greater than the high setpoint. If relay 1 is ON, the digital display will flash, visually indicating the alarm condition to the operator.

Once a relay turns ON, it stays ON until the displayed value returns back across the setpoint "and then some". The "and then some" is called hysteresis. Hysteresis is a programmable value that is common to both setpoints and both relays. This means that a relay turns OFF when the display is less than or equal to the high setpoint minus the hysteresis value, or when the display is greater than or equal to the low setpoint plus the hysteresis value. Should an overlap occur between ON and OFF conditions, the ON condition overrides the OFF condition.

DESCRIPTION cont.

Example: Relay Output Operation

High Setpoint = 4	Relay ON above 4
Low Setpoint = -3	Relay ON below -3
Hysteresis = 2	Relay OFF below 2 and above -1

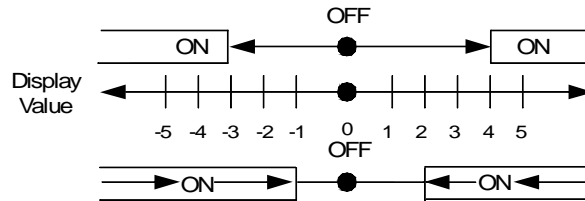

Analog Retransmission Option Board

The optional analog output board provides linear 0-10 V and 4-20 mA signals. When the displayed value is equal to the programmed output offset value, the output voltage is zero and the output current is 4 mA. When the displayed value is equal to the programmed output full scale value, the output voltage is 10 V and the output current is 20 mA.

When the displayed value is between the output offset and output full scale value:

1. The output voltage = $10 \times \frac{(\text{displayed value} - \text{output offset})}{(\text{output full scale} - \text{output offset})}$ V,
2. The output current = $16 \times \frac{(\text{displayed value} - \text{output offset})}{(\text{output full scale} - \text{output offset})}$ mA + 4 mA

RS 485 Serial Communications Option Board

The optional serial communication board allows a host device to download and read programming parameters and to read status information from the DPM, such as display value, relay status, etc.

This manual does not contain information on the serial communication protocol or the serial command list. That information is contained in the 57700 serial specification and is obtainable by contacting the Durant Literature Department at 800-540-9242 (U.S. and Canada), or 920-261-4070, or by FAX at 920-261-9097.

MOUNTING

Mounting

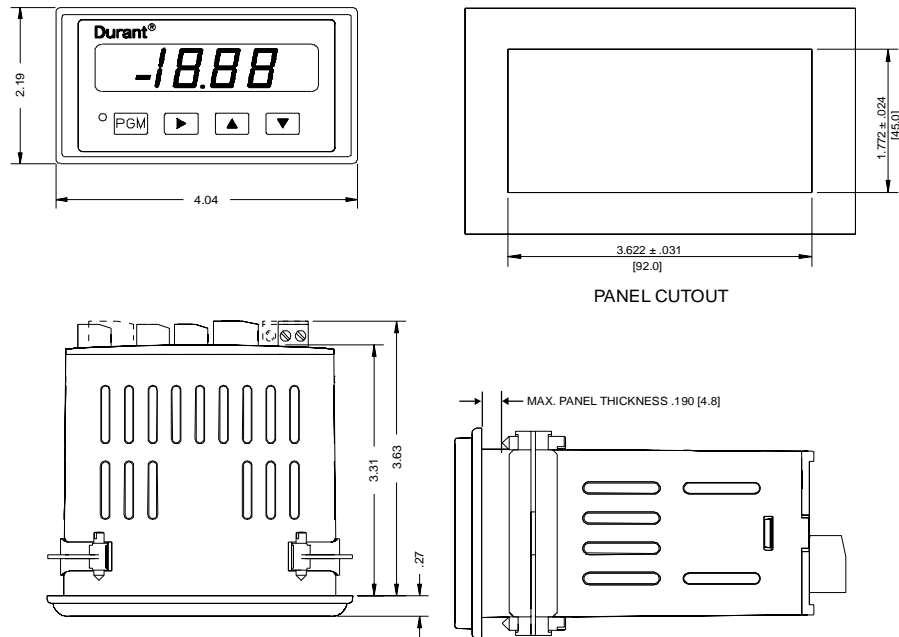

Mounting clips and screws shown in installed positions.

Mounting Instructions

1. Slide mounting gasket (not shown) over unit body until adhesive surface makes contact with the front bezel.
2. Slide unit into cutout in panel.
3. Attach mounting clips and screws.
4. Tighten screws until unit is firmly in place. **DO NOT OVERTIGHTEN** screws to the point of squeezing the gasket out from behind the bezel.

WIRING

WIRING AND DIP SWITCHES

All wiring to the DPM is done via rear terminal, de-pluggable connectors. Up to five headers accept the wired connectors on the DPM. All units have at least two headers, power input and signal input. Any combination of three additional circuit boards with headers may be installed. These option boards are relay output, RS 485 serial communications, and analog retransmission. The option boards occupy specific locations in the DPM and are not interchangeable. All boards are keyed to prevent installation in the wrong location.



Disconnect all power before wiring terminals. A safety hazard exists if this precaution is not observed. Treat all control and count inputs as hazardous since they may carry line voltage.

Rear Terminal Layout

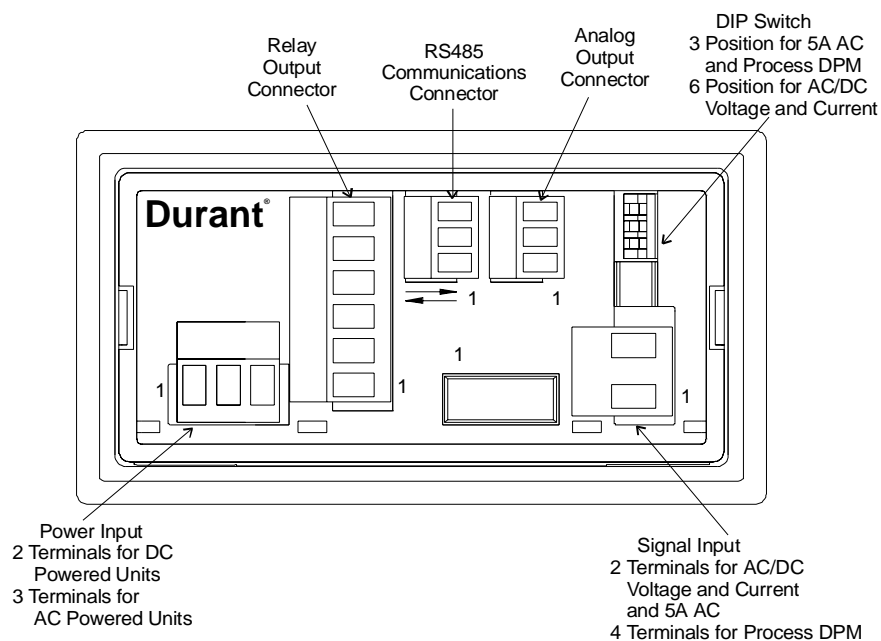

Terminal Connector Ratings:

AC or DC Power Input / Relay Output / Signal: 10A, 250VAC;
Wire size: 12-24AWG (3.1mm² - 0.24mm²), 600V.
RS485 / Analog Output / Signal: 8A, 125VAC;
Wire size: 16-28AWG (1.3mm² - 0.1mm²), 300V.

WIRING cont.

Wiring and DIP Switches

DC Power Input (for DC powered models 57700-4XX)

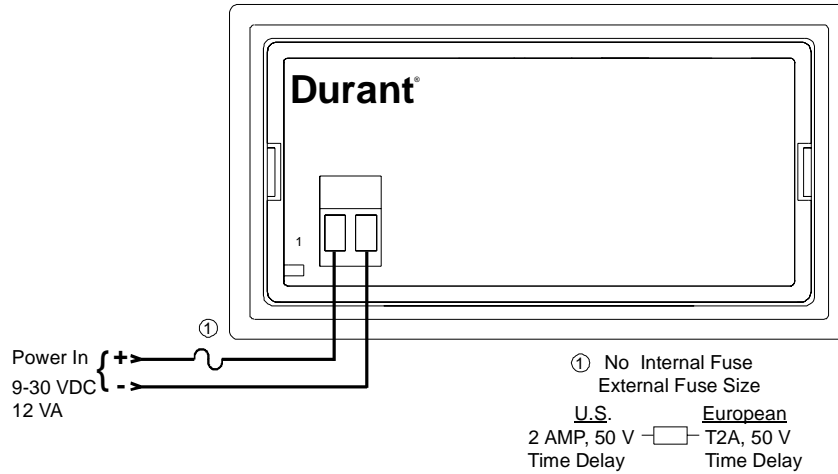

AC Power Input (for AC powered models 57701-4XX)

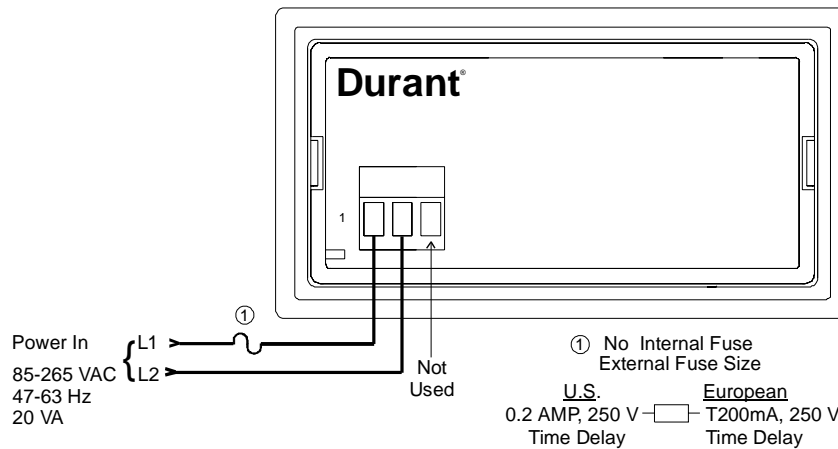

WIRING cont.

Signal Input for AC/DC Voltage and Current and 5AAC

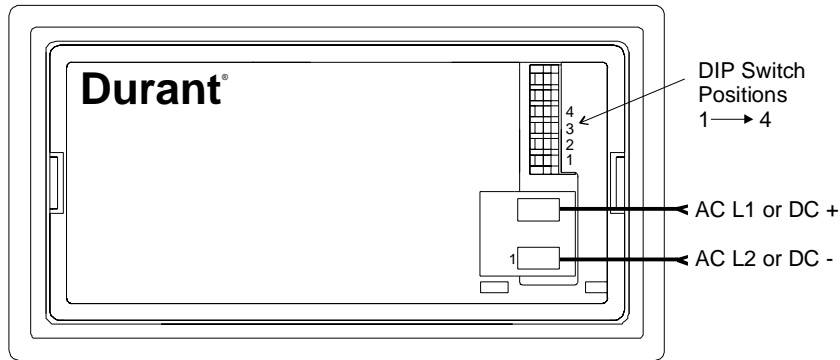

AC/DC Voltage and Current DIP switch selectable ranges:

Switch 4 ON - 200 V / 200 mA
Switch 3 ON - 20 V / 20 mA

Switch 2 ON - 2.0 V / 2.0 mA
Switch 1 ON - 0.2 V / 0.2 mA

See Specifications (pages 17-19) for Input Impedances and Overage

Signal Input for Process DPM Model 5770X-45X

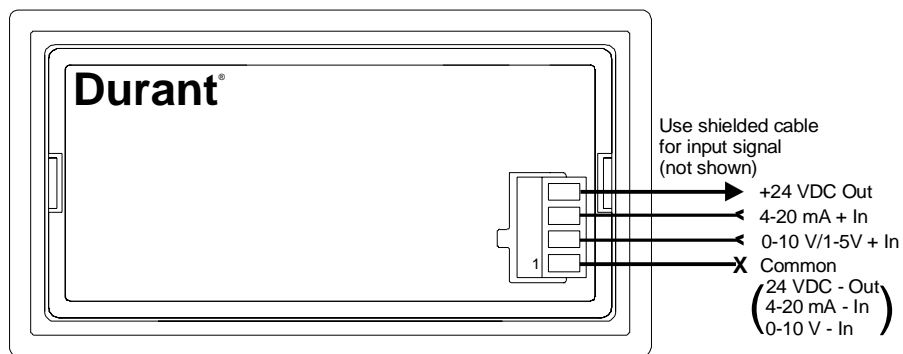

24 VDC Transducer Output Power Ratings:

24 VDC, 90 mA maximum, short circuit protected

See Specifications (pages 17-19) for Input Impedances and Overage

WIRING cont.

Relay Output Option Board
Typical Wiring

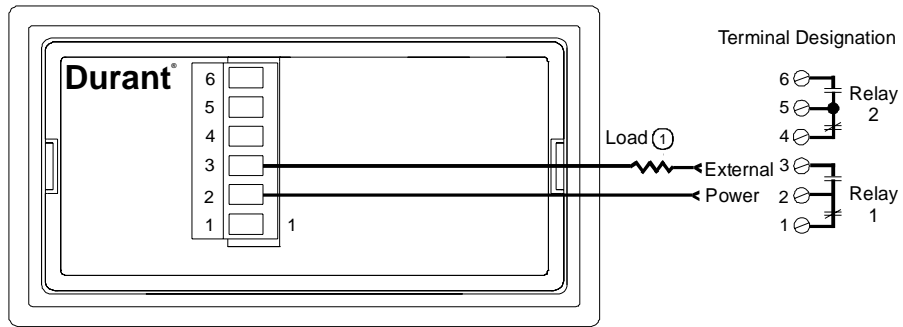

Contact Ratings
5 A @250 VAC or 30 VDC maximum

① An RC surge suppressor is recommended across all inductive loads.

RS 485 Communication Option Board

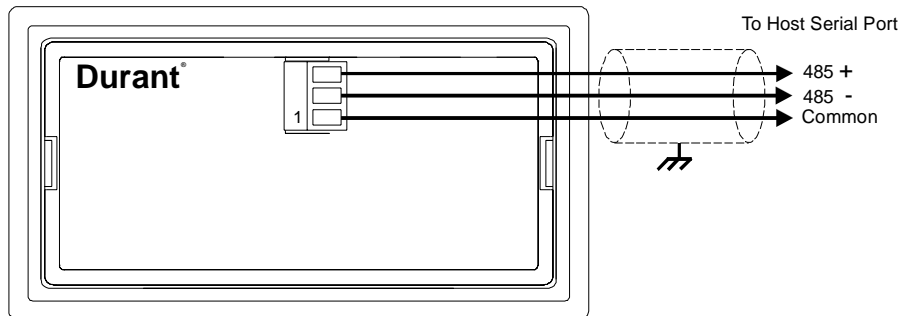

WIRING cont.

Analog Output Option Board

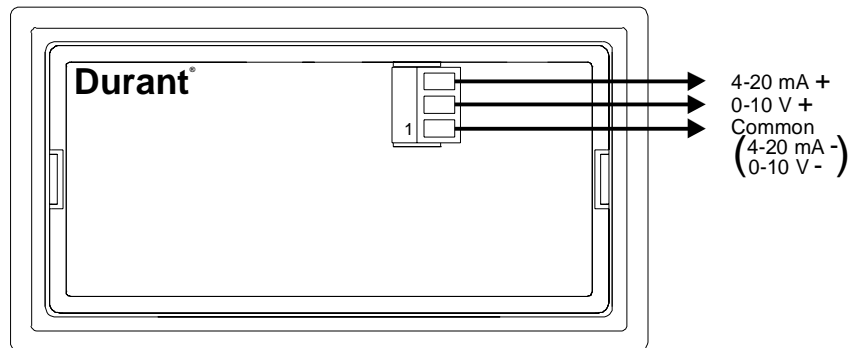

Output Ratings

- 4-20 mA into 750 Ω (Ohms) maximum
- 0-10 V into 2500 Ω (Ohms) minimum

General Wiring Practices

An emergency stop switch should be included in the installation:

- It shall be in close proximity to the equipment and within easy reach of the operator.
- It shall be marked as the disconnecting device for the equipment.
- Switches and circuit breakers in Europe must comply with IEC 947.

Other considerations:

- Use shielded cables for signal and control inputs.
- Keep all signal lines as short as possible (< 30 meters or 100 feet).
- Do not bundle or route signal lines with power or machine control wiring.
- Do not allow signal or control lines to leave the building.

PROGRAMMING

PROGRAMMING

Entering the Program Mode



Note: If the optional relay output and/or analog output board(s) are installed in the DPM, entering the program mode will cause both relays to turn off and the analog output to go to its minimum values (0V and 4 mA) regardless of the input signal value.

To enter the program mode:

1. Flip the rear terminal program enable DIP Switch ON.

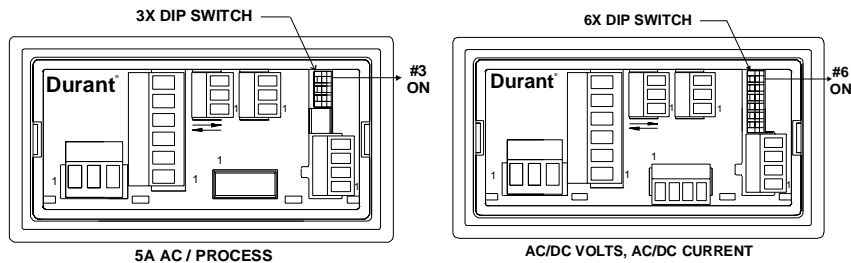

2. Press and hold the front panel program key (PGM); the display will say run:

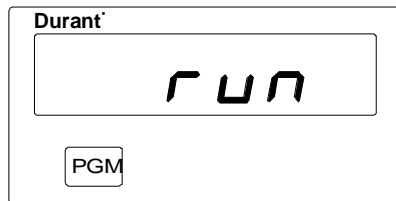

3. Press the up or down arrow key (▲) or (▼) while holding (PGM); the pro-

gram LED will turn ON and the display will show a parameter name.

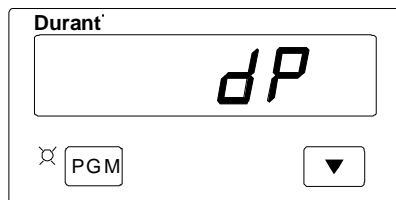

PROGRAMMING cont.

Programming Parameters

Programming customizes the DPM's functions to fit the application. All programming may be done by using the front panel program (**PGM**) and arrow keys - up (**▲**), down (**▼**), and right (**▶**). Programming is done by entering the proper value into each programming parameter. The parameters each have a name and a value, and are shown in the program list starting on page 12. The programming parameters associated with the optional RS485 communications board, the analog retransmission board, and the relay output board only show in the program list if the corresponding option board is installed in the DPM.

To navigate through the parameter list, use the program, up, and down arrow keys.

1. The parameter name is displayed by pressing and holding the program key (**PGM**).
2. The value of the parameter is displayed by releasing the program key.
3. While holding the program key (**PGM**), the unit scrolls down one parameter name each time the down arrow (**▼**) key is pressed, and scrolls up one parameter name each time the up arrow (**▲**) key is pressed. When the **PGM** key is released, the display shows the value of the selected parameter.

To change the value of the selected parameter:

1. Press the right arrow key (**▶**); something on the display will begin to flash (this could be a single digit, the decimal point, or the entire display).



PROGRAMMING cont.

2. Press the or key to change the selection of the flashing portion of the display.

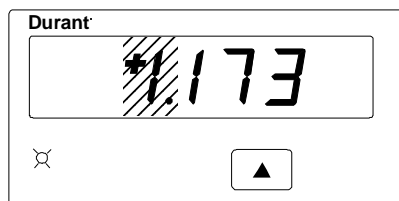

3. Press to enter the new value and go back to the parameter name.

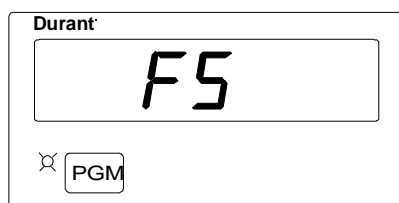

The numeric entries for offset, full scale, serial address, output offset, output full scale, relay setpoints, and relay hysteresis are edited one digit at a time. The plus/minus sign is selected with the most significant digit. Press to select which digit to change (flash), then use or to change the value of the flashing digit. After all digits have been edited, press to go back to the parameter name.

After programming is completed, turn the program enable DIP switch OFF.

The Parameter List

The following list shows all programming parameter names, the default value for each, and the selection range for each. A programmed unit may be returned to the default state by simultaneously pressing both the program () and right arrow () keys for one second. The display will show dFL while the keys are pressed and blink OFF momentarily when the default is done.

PROGRAMMING cont.

br **19.2**

Baud Rate. Select the rate in kBaud at which to receive and transmit serial information.

1.20
2.40
4.80
9.60
19.2

PAR **no**

Parity. Select the type of parity used for serial communications.

no none
Even even
odd odd

oOF **0000**

Analog Output Offset Value. Enter the displayed value that corresponds to the minimum analog output (0V and 4 mA).
Range: -9999 to 9999.

oFS **1000**

Analog Output Full Scale Value. Enter the displayed value that corresponds to the maximum analog output (10V and 20 mA).
Range: -9999 to 9999.

1H, **9999**

Relay 1 High Alarm Setpoint. Enter the displayed value at which relay 1 will turn ON if the display goes above this value.
Range: -9999 to 9999.

1Lo **-9999**

Relay 1 Low Alarm Setpoint. Enter the displayed value at which relay 1 will turn ON if the display goes below this value.
Range: -9999 to 9999.

2H, **9999**

Relay 2 High Alarm Setpoint. Enter the displayed value at which relay 2 will turn ON if the display goes above this value.
Range: -9999 to 9999.

2Lo **-9999**

Relay 2 Low Alarm Setpoint. Enter the displayed value at which relay 2 will turn ON if the display goes below this value.
Range: -9999 to 9999.

PROGRAMMING cont. /RUN MODE/ DIAGNOSTICS

H 95

0000

Relay Hysteresis. Enter the value in display units between the relay turn ON values and relay turn OFF values.
Range: 0 to 999.

RUN MODE

Once the unit is installed, it normally displays a value which is updated every 0.4 seconds. However, each time the display updates, the new value is compared internally to captured maximum and minimum values. If the new value is greater than the maximum, or less than the minimum, then it becomes the new max or min value held in memory. The max and min capture and hold process is always going on. In order to display the max value, press the up arrow key. The max value will remain on the display for as long as the key is pressed, and for another 2.5 seconds after the key is released. To display min value, press the down arrow key. The min value also remains on the display as long as the key is pressed, and for another 2.5 seconds after it is released. To reset both the max and min values to the latest update value, press and hold both up and down arrow keys for 2 seconds. The display will read reset (rSt), and then it will revert to the update display once the reset is complete.

The final variation of the run mode display occurs only in units that are equipped with the optional output relay board. If relay 1 is ON (alarm active), the display will flash the update value. Users that do not want the display to flash during an alarm state should use relay 2 as the alarm relay.

DIAGNOSTICS

Self Diagnostics and Error Messages

Each time power is applied to the DPM, it performs a series of internal diagnostic tests. A lamp test (all display segments ON) is conducted while these tests are in progress. If a failure occurs, an error message will appear on the display. Additionally, once the unit is up and running, an out of range message (flashing **OL** or **-OL**) may occur, indicating that the scaled input signal (display reading) is greater than 9999 or less than -9999 respectively (disregard the decimal point place).

The diagnostic tests are checksum calculations of internal memory, to verify that data stored in memory at power down is still there at power up. The first tests are performed on internal ROM and RAM. Failure results in an error message **Err**. This error is non-recoverable, and the unit should be returned to the factory for repair.

Programming and calibration data is stored in non-volatile memory (NOVRAM). A failure in the programming section of NOVRAM results in the displayed error message **Prg**, which remains on the display until power is cycled OFF, then ON, to the unit, or until a key is pressed. When a **Prg** errors occur, the unit loads default

DIAGNOSTICS cont.

values into all programming parameters. This error is recoverable by re-programming the DPM. An error message **CAL** indicates that the calibration section of NOVRAM, or both sections, has been corrupted, or that the calibration data does not match the input board type. **THERE IS NO DIAGNOSTIC TEST TO DETERMINE THAT THE DPM IS CALIBRATED!** In this case, the unit loads default values into all programming and calibration parameters. This error is recoverable by re-programming and re-calibrating the unit. If subsequent **PrG** or **CAL** errors occur, the NOVRAM itself may have failed and the unit should be returned to the factory for repair.

Keyboard Diagnostic Mode

The keyboard diagnostics allows the user to test each of the front panel keys, the display, and the analog retransmission and relay outputs if those optional boards are installed.



Caution: performing the diagnostic tests will turn on the analog transmission and relay outputs if those options are installed. Remove power from the DPM and disconnect the outputs from any loads that should not be turned on before entering the keyboard diagnostic mode. If the optional RS485 communication board is installed, the DPM will respond with the scaled input value to the QST command.

To enter the keyboard diagnostic mode:

1. Turn power to the unit OFF.

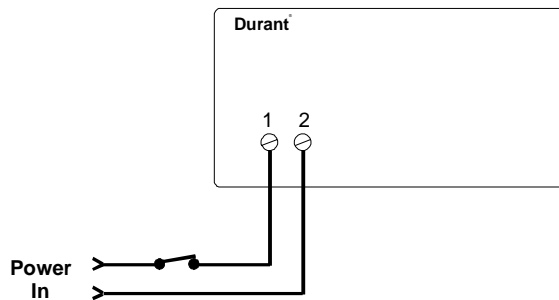

DIAGNOSTICS cont.

- Flip the rear terminal program enable DIP switch ON.

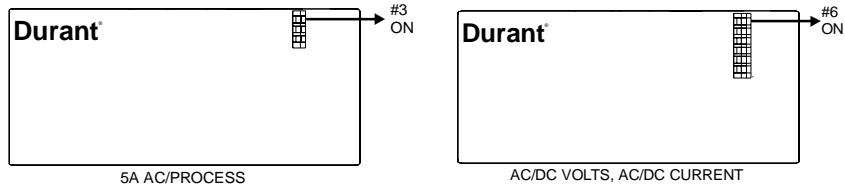

- While holding both the right arrow key (▶) and the up arrow key (▲), turn unit power ON.

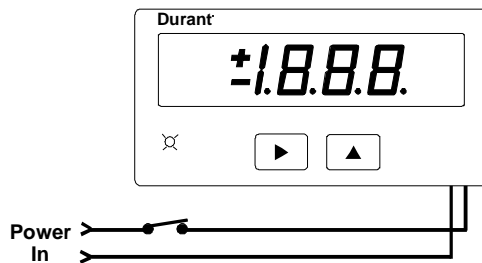

The program LED and all display segments will be ON. If present, both relays will be OFF (coils de-energized) and the analog output will be at minimum value (4 mA and 0V).

There are four keyboard diagnostic tests, one for each key. The tests are performed by pressing each key. The unit's response is maintained as long as the key is held.

Test Key	Unit Response
Program PGM	Display shows software part number
Right Arrow ▶	All display segments and the program LED turn OFF and the analog output goes to maximum value (20 mA and 10V).
Up Arrow ▲	Each display digit will turn ON, one at a time, and relay 2 will turn ON.
Down Arrow ▼	Each display segment of all displays will turn ON, one segment at a time, and relay 1 will turn ON.

To exit the diagnostic mode, turn unit power OFF.

SPECIFICATIONS

MECHANICAL

Cutout Dimensions: 3.62" W x 1.77" H (92mm x 45mm) DIN standard
Outline Dimensions: 4.04" W x 2.19" H x 3.87" D (103mm x 56mm x 98mm)
3.60" (92mm) maximum depth in panel
Enclosure: Plastic with polyester front label
Connectors: Up to five de-pluggable terminal blocks

INPUT POWER

AC Powered Models (57701-4XX)

Input Power: 85-265 VAC, 47-63 Hz, 20 VA
External Fuse: 0.2A, 250 VAC, Time Delay (T200mA, 250V)
Isolation Dielectric Strength: 2300 VAC

DC Powered Models (57700-4XX)

Input Power: 9-30 VDC, 12 VA
External Fuse: 2.0A, 50 VDC, Time Delay (T2A, 50V)
Reverse Voltage Protection: Yes
Isolation Dielectric Strength: 2300 VAC to signal inputs and relays, 500 VAC to RS485 and analog outputs

HUMAN INTERFACE

Display: +/- 4 full digits
Type: .56" high, seven segment, red LED
Update Time: 0.4 seconds
Alarm: Flashing display
Indicator: One red LED program/calibration indicator with max./min. capture and hold

DATA RETENTION

Memory Type: EEPROM, no batteries required
Duration: 100 years

SIGNAL INPUT

DC Voltage Models (5770X-40X)

Range: +/- 199.9 mVDC, +/- 1.999 VDC, +/- 19.99 VDC, +/- 199.9 VDC, DIP Switch Selectable
Impedance: 1 M Ω (ohms)
Overrange: 750 VDC/530 VAC except 220 VDC/AC on 199.9 mV range
Accuracy: +/- 0.1% of reading, +/- 0.03% FS, +/- 0.5 digit, and +/- 80 PPM/ $^{\circ}$ C

SPECIFICATIONS cont.

AC Voltage Models (5770X-41X)

Range: 199.9 mVAC, 1.999 VAC, 19.99 VAC, 199.9 VAC, DIP Switch Selectable, all ranges true RMS
Frequency: 40 to 1000 Hz
Impedance: 1 M Ω (capacity coupled)
Overrange: 750 VDC/530 VAC except 220 VDC/AC on 199.9 mV range
Accuracy: +/- 0.5% of reading, +/- 0.13% FS, +/- 0.5 digit, +/- 180 PPM/ $^{\circ}$ C for crest factor = 1 plus +/- 0.7% for crest factor = 1 to 3 and +/- 2.5% for crest factor = 5

DC Current Models (5770X-42X)

Range: +/- 199.9 μ ADC, +/- 1.999 mADC, +/- 19.99 mADC, +/- 199.9 mADC, DIP Switch Selectable
Impedance: 199.9 mV/selected range
Overrange: 30 mA (199.9 μ A range), 100 mA (1.999 mA range), 300 mA (19.99 mA range), 1A (199.9 mA range)
Accuracy: +/- 0.1% of reading, +/- 0.03% FS, +/- 0.5 digit, and +/- 120 PPM/ $^{\circ}$ C

AC Current Models (5770X-43X)

Range: 199.9 μ AAC, 1.999 mAAC, 19.99 mAAC, 199.9 mAAC, DIP Switch Selectable, all ranges true RMS
Frequency: 40 to 1000 Hz
Impedance: 199.9 mV/selected range (shunt output capacitively coupled)
Overrange: 30 mA (199.9 μ A range), 100 mA (1.999 mA range), 300 mA (19.99 mA range), 1A (199.9 mA range)
Accuracy: +/- 0.5% of reading, +/- 0.13% FS, +/- 0.5 digit, and +/- 200 PPM/ $^{\circ}$ C for crest factor = 1 plus +/- 0.7% for crest factor = 1 to 3 and +/- 2.5% for crest factor = 5

5AAC Models (5770X-44X)

Range: 5AAC, true RMS
Frequency: 40 to 1000 Hz
Impedance: 0.02 ohms (shunt output capacitively coupled)
Overrange: 10A Maximum
Accuracy: +/- 0.4% of reading, +/- 0.13% FS, +/- 0.5 digit, and +/- 200 PPM/ $^{\circ}$ C for crest factor = 1 plus +/- 0.7% for crest factor = 1 to 3 and +/- 2.5% for crest factor = 5

Process Models (5770X-45X)

Range: 4-20 mADC, 0-10 VDC, 1-5 VDC; separate input terminals for voltage and current signals
Impedance: 100 Ω (current input) and 1.27 M Ω (voltage input)
Overrange: 50 mA maximum (current input) and 100 V maximum (voltage input)
Power Output: 24 VDC +10%/-12%, 90 mA max, short circuit protected
Accuracy: +/- 0.1% of reading, +/- 0.03% FS, +/- 0.5 digit, and +/- 80 PPM/ $^{\circ}$ C

SPECIFICATIONS cont.

OPTIONAL OUTPUTS

Relay Board

Dual relay: 1 set of form C contacts each
Contact rating: 5A, 250 VAC or 30 VDC
Isolation dielectric strength: 2300 VAC

Analog Retransmission

Output signals: 4-20 mA (<750 Ω) and 0-10 V (>2500 Ω)
Accuracy: 0.13% FS, 100 PPM /°C, 0.07% FS change with 4-20 mA load, +/-0.3% FS for 4-20mA output, only after exposure to 85% relative humidity
Isolation dielectric strength: 2300 VAC to signal inputs, relays, & AC power input, 500 VAC to RS 485 and DC power inputs

RS 485 Serial Communications

Baud Rate: 1200, 2400, 4800, 9600, or 19,200, programmable
Parity: Even, odd, or no parity
Address Range: 00 to 99 decimal
Protocol: Opto 22[®] compatible
Isolation Dielectric Strength: 2300 VAC to signal inputs, relays, and AC power input, 500 VAC to analog outputs and DC power inputs

ENVIRONMENTAL

Operating Env.: Indoor use to 2000 meters
Temperature: Operating: 0 to 50°C, Storage: -20 to 70°C
Humidity: 0 to 85% RH, non-condensing
Vibration: 2.5 g's, 30 to 200 Hz
Shock: 30 g's, 11 msec half sinewave
EMC/EMI: Per EN 61326-1 Industrial
Front Panel: NEMA 4X when mounted with gasket provided
Agency Approval: UL, cUL listed, CE compliant
CE EMC immunity and emissions requirements were met using shielded wiring on the RS-485, analog output, and signal input lines. The shields were connected to earth ground at the Eclipse end of the shields.

Conducted emissions requirements were met assuming that the AC signal input would not be connected directly to the AC Mains.

The measurement error during RF immunity testing was less than +/-5% of full scale. In addition, models with an AC signal input had measurement error of less than +25% of full scale during RF immunity testing of the RS-485 at frequencies below 1MHz.

Pollution Deg. 2: Overvoltage Category II

WARRANTY

Eaton warrants all products against defects in material and workmanship for a period of one (1) year from the date of shipment to Buyer. This is a limited warranty limited to its terms. This warranty is void if the product has been altered, misused, taken apart or otherwise abused. **ALL OTHER WARRANTIES, EXPRESS OR IMPLIED, ARE EXCLUDED, INCLUDING BUT NOT LIMITED TO THE IMPLIED WARRANTIES OF MERCHANTABILITY AND FITNESS FOR PURPOSE.**

BUYERS REMEDIES: Eaton's obligations and liabilities under the foregoing warranty are limited to repair or replacement of the product without charge. To receive the required Return Goods Authorization number (RGA), contact your local Durant distributor or call 1-800-540-9242 to get a list of distributors in your area. A charge is made for repairing after the expiration of the warranty. IN NO EVENT SHALL EATON BE LIABLE FOR CLAIMS BASED UPON BREACH OF EXPRESS OR IMPLIED WARRANTY OR NEGLIGENCE OR ANY OTHER DAMAGES WHETHER DIRECT, IMMEDIATE, FORESEEABLE, CONSEQUENTIAL OR SPECIAL OR FOR ANY EXPENSES INCURRED BY REASON OF THE USE OR MISUSE, SALE OR FABRICATION OF PRODUCTS WHICH DO OR DO NOT CONFORM TO THE TERMS AND CONDITIONS OF THIS CONTRACT.

INDEMNIFICATION: Buyer agrees to hold Eaton harmless from, defend, and indemnify Eaton against damages, claims and expenses arising out of subsequent sales of Durant products or products containing components manufactured by Eaton and based upon personal injuries, deaths, property damage, lost profits, and other matters for which Buyer, its employees or sub-contractors are or may be to any extent liable, including without limitation penalties imposed by the Consumer Product Safety Act (P.L.92-573) and liability imposed upon any person pursuant to the Magnuson-Moss Warranty Act (P.L.93.637), as now in effect or as amended hereafter. The warranties and remedies provided for herein are available to Buyer and shall not extend to any other person.

COMPLIANCE WITH OSHA: Eaton offers no warranty and makes no representation that its products comply with the provisions or standards of the Occupational Safety and Health Act of 1970, or any regulations issued thereunder. In no event shall Eaton be liable for any loss, damages, fines, penalty or expense arising under said ACT.

This manual constitutes proprietary information of Eaton Corp., and is furnished for the customers' use in operating the Durant counter. Reproduction of this material for purposes other than the support of Durant counters or related products is prohibited without the prior written consent of Eaton Corp., Watertown, WI.

In the construction of the Control described herein, the full intent of the specifications will be met. Eaton Corp., however reserves the right to make, from time to time and without proper written notice, such departures from the detail specifications as may be required to permit improvements in the design of the product.

The information included herein is believed to be accurate and reliable; however no responsibility is assumed by Eaton Corp., for its use; nor for any infringements of patents or other rights of third parties which may result from its use.

This equipment is capable of generating radio frequency energy. If not installed and used in accordance with the instructions, this unit may interfere with radio communications.

Durant
901 S. 12th Street
Watertown, WI 53094
800/540/9242 • 920-261-4070
Fax 920-261-9097
www.durant.com