

At 90° Outside Corner, position ALA3818 External Elbow at end of ALA3800B-10 Base. Slide other base section to other end of ALA3818. Center couplings on joints and tighten screws. After wiring system, snap on ALA3818 mitered covers.

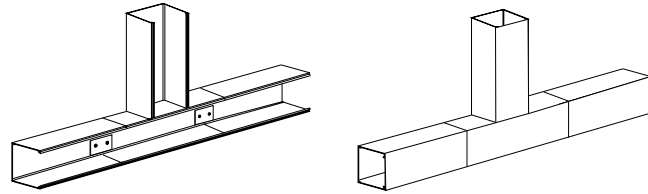

ALA3815

ALA3815 Tee: Position fitting at end of ALA3800B-10 Base. Install other base sections to other ends of the fitting. Center couplings on joints and tighten screws. Install fitting covers after wiring.



ALA3800 ALUMINUM RACEWAY

Installation Instructions

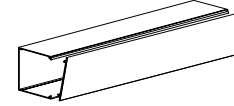

The ALA3800 is a permanent single-channel raceway that is versatile enough to accommodate power, data or telecommunication wiring.

NOTE: Cross-sectional area of each compartment indicated.

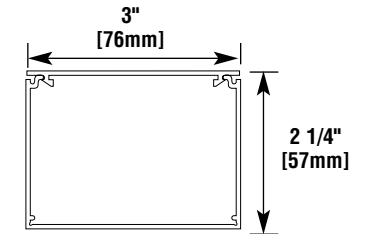

Wiremold Electrical Systems conform with, and should be installed and properly grounded in compliance with requirements of the current National Electrical Code or codes administered by local authorities. All electrical products may represent a possible shock or fire hazard if improperly installed or used. Wiremold electrical products are UL listed, made for interior use in a dry location and should be installed by qualified electrical people in conformance with current local and/or the National Electrical Code.

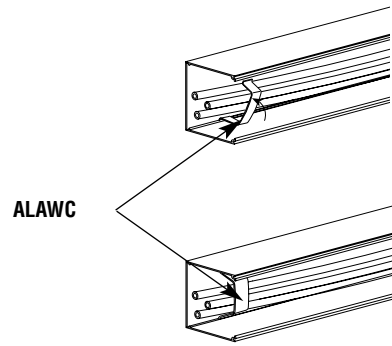

ALAWC

For retaining wires in long raceway runs, snap-in ALAWC Series Wire Clips into ALA3800B-10 Base approximately 30" [762mm] apart.

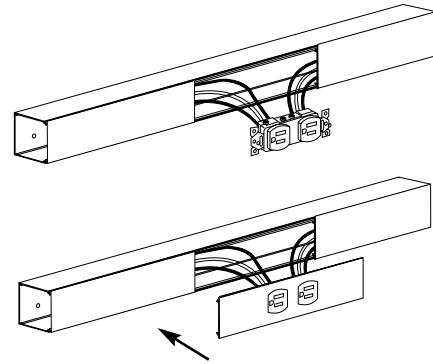

For Device Plates (ALA-BL, ALA-E, ALA-DR, ALA-G, ALA-J, ALA-N, ALA-LPB, ALA-MAB, ALA-SG, ALA-2A, and ALA-Z), install wiring to devices as required. Attach devices to plate (using #6 screws and "Keps" nuts as required.) Snap device plate onto ALA3800B-10 Raceway Base.

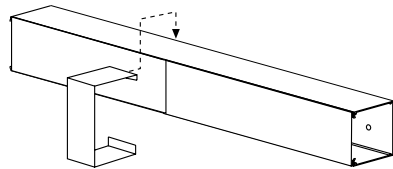

Snap ALA3806 Cover Clip over joints in either ALA3800B Base or ALAC-5 Cover sections.

ALA3800 Raceway Cable Fill Capacity for Data/Communication

	CABLE/WIRE SIZE	O.D. INCHES [MM]	20% FILL	40% FILL
UNSHIELDED TWISTED PAIR	4-Pair, 24 AWG Cat. 5	0.220 [5.6]	31	62
	4-Pair, 24 AWG Cat. 3	0.190 [4.8]	41	83
TELEPHONE	2-Pair, 24 AWG	0.140 [3.6]	77	154
	3-Pair, 24 AWG	0.150 [3.8]	67	134
	4-Pair, 24 AWG	0.190 [4.8]	41	83
	25-Pair, 24 AWG	0.410 [10.4]	8	17
COAXIAL CABLES	RG58/U 18	0.195 [5.0]	39	79
	RG59/U 22	0.242 [6.1]	25	51
	RG62/U 20	0.242 [6.1]	25	51
	RG6/U 22	0.270 [6.9]	20	41
TWINAXIAL	100 Ohm	0.330 [8.4]	13	27
SHIELDED TWISTED PAIR	TYPE 1	0.390 [9.9]	9	19
	TYPE 2	0.465 [11.8]	6	13
	TYPE 3	0.245 [6.2]	25	50
FIBER OPTIC	Two Strand (Duplex) Multimode 62.5/125 µm	0.190 [4.8]	41	83

*Capacity range is calculated at 20% to 40% of raceway area as stated in a proposed revisions to the Commercial Building Standard for Telecommunication Pathways & Spaces, EIA/TIA-569. Actual wire fill capacity may vary based on applications, cable types, and number, as well as type of fittings. (Fittings may cause additional variances to the fill capacity.)

ALA3800 Raceway Cable Fill Capacity for Power

	WIRE SIZE THHN/THWN	O.D. INCHES [MM]	40% FILL
POWER WIRING WITHOUT DEVICES	6 AWG	0.257 [6.5]	41
	8 AWG	0.218 [5.5]	56
	10 AWG	0.153 [3.9]	98
	12 AWG	0.122 [3.1]	156
	14 AWG	0.105 [2.7]	214
POWER WIRING WITH DEVICES	6 AWG	0.257 [6.5]	30
	8 AWG	0.218 [5.5]	42
	10 AWG	0.153 [3.9]	73
	12 AWG	0.122 [3.1]	116
	14 AWG	0.105 [2.7]	159



The Wiremold Company

In U.S.:

60 Woodlawn Street • West Hartford, CT 06110

1-800-621-0049 • FAX 860-232-2062

In Canada:

850 Gartshore Street • Fergus, Ontario N1M 2W8

1-800-741-7957 • FAX 519-843-5980

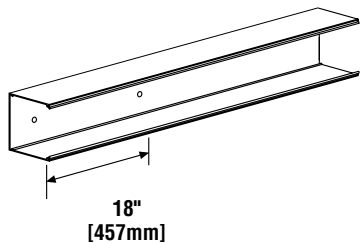

18"
[457mm]

To attach ALA3800B-10 Series Base sections to mounting surface; drill 9/32" [7.14mm] holes in the base (approx. 18" [457mm] O.C.). Fasten Base with #8 flat head screws.

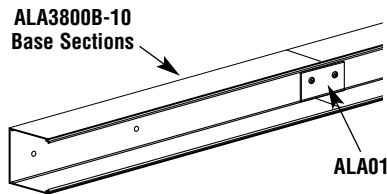

ALA3800B-10
Base Sections

ALA01

At ALA3800B-10 Base section butt joints: slide an ALA01 Coupling into first base section. Mount next base to surface. Center coupling on joint. Tighten locking screws.

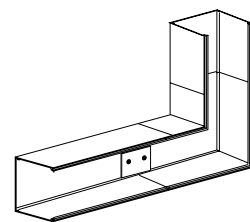

ALA3811

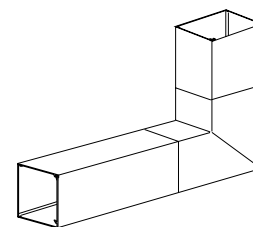

ALA3811 With Cover

At 90° turn on same surface, position ALA3811 Flat Elbow at end of ALA3800B-10 Base. Position next base section onto other end of ALA3811. Center coupling over base joint and tighten screws. Install ALA3811 Covers and ALA3800 Series Covers as shown after wiring.

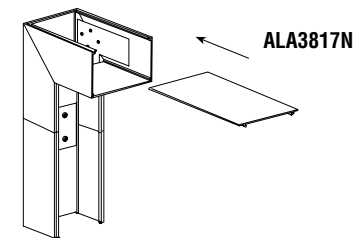

ALA3817N

For connecting a vertical run of ALA3800B-10 Base with a horizontal overhead run with its cover facing up. Assemble ALA3817N to raceway bases with ALA01 Couplings included.

System Layout

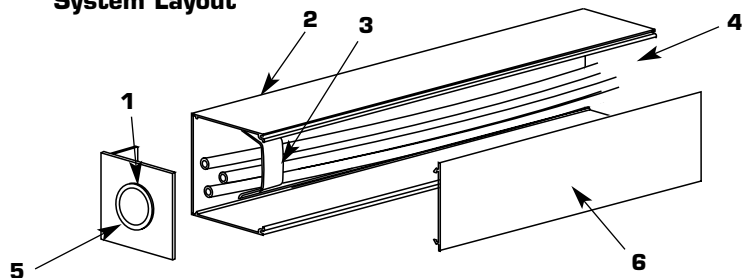

- 1 - Provide electrical feed through the concentric 1/2" [12.7mm] and 3/4" [19.1mm] KO in ALA3810B1 End Cap.
- 2 - Attach base section to mounting surface by drilling 9/32" [7.14mm] holes in the base then fastening with #8 flat head screws.
- 3 - Secure conductors in place with ALAWC Wire Clip.
- 4 - Join additional raceway sections with an ALA01 Coupling.
- 5 - Close ends with ALA3810B1 End Caps.
- 6 - Snap ALAC-5 Cover into ALA3800B-10 Base to complete installation.

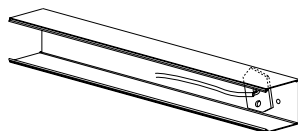

Position ALA09 Ground Clamp into ribs in ALA3800B-10 Base. Fasten mounting screw. Attach ground wire using brass cup washer & green hex nut to ground lug.

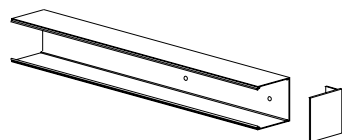

At end of ALA3800B-10 Raceway run: slide ALA3810B Blank End Fitting in last base section. Secure in place by tightening two screws.

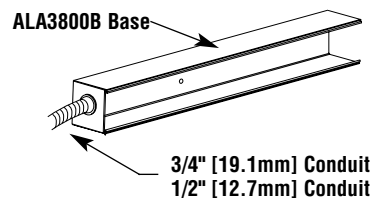

ALA3810B Base

3/4" [19.1mm] Conduit
1/2" [12.7mm] Conduit

(ALA3810B shown)
End-feeding: ALA3810B1 Series End Fittings have concentric 1/2" [12.7mm] and 3/4" [19.1mm] trade size KOs in end. Provide electrical feed through KOs. Insert fitting into end of raceway base. Secure in place by tightening two screws.

Options for 90° Internal Corners:

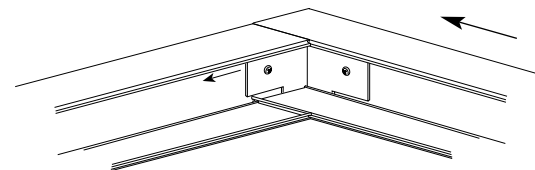
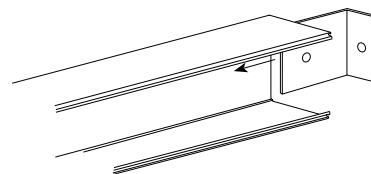

ALA17A Internal Corner Coupling

Install one side of ALA17A Internal Coupling, **BEFORE** mounting raceway base. Fasten first base section to wall, then slide adjoining base onto coupling legs. Tighten all coupling screws.

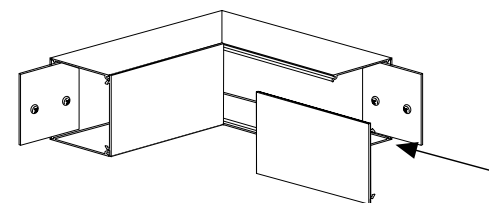
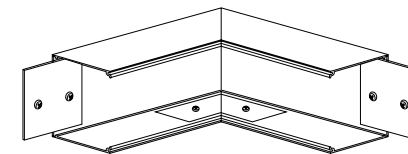

ALA3817 Internal Elbow

Install ALA3817 to first raceway base, **BEFORE** mounting raceway base. Fasten base section to surface. Butt next section of base. Center couplings over base joints, tighten set screws.