

Heavy-Duty Plug-In Switches

Contents

Overview	1
Model Selection, Assembled Switches	2
Model Selection, Operating Heads	5
Model Selection, Switch Bodies	6
Model Selection, Receptacles	7
Model Selection, Accessories	8
Specifications	10
Dimensions	11

Cutler-Hammer® E50 Modular Plug-In Limit Switch Components from Eaton's electrical business are the industry standard with versatility of design and high reliability for low maintenance, installation and inventory costs. Standard Viton® gaskets, seals and boots and a zinc die cast enclosure provide exceptional chemical resistance to the common coolants, cleansing agents, and hydraulic fluids found in machine tool, automotive, waste water treatment and other heavy-duty industrial applications. Mounting dimensions accommodate both U.S. and DIN standards for easy retrofit installations. Super bright 24 – 120V AC/DC LED indicating light versions simplify setup and troubleshooting operations.

Approvals

- UL Listed
- CSA Certified
- IEC.947.5.1
- TUV — E9271605E02

CE (where shown)



Unless otherwise noted, the products contained in this document are not designed or intended for use in human safety applications.

Viton® is a registered trademark of Dupont Dow Elastomers.

Modular Limit Switches Provide Extremely Easy Installation, High Reliability, and Low Maintenance and Inventory Costs

Available as Assembled Switches or Components

Dozens of Operators to Perfectly Fit Your Application

Rotary, Top and Side Push, Wobble and Specialty Operating Heads

Single- or Double-Pole Switch Bodies with Optional Indicating Lights

A Variety of Receptacles Meet Your Wiring Needs

Product Features

- Modular, plug-in components (head, body and receptacle) provide application flexibility, reduced inventory and less downtime
- Manufactured to take the physical and environmental abuse (including cutting fluids and chemicals) of harsh industrial environments
- Chemical resistant Viton® gaskets, seals and boots are standard, and so are captive, posi-drive screws
- The switches have terminal identification on the nameplate for a visual wiring check-out without guesswork. Heads and switch bodies can be replaced without rewiring
- E50 devices can be ordered in separate components or as complete assembled switches
- 600V rating, ridge-topped contacts and wiping action assure continuity even to logic level circuits
- Keyed, four direction head positioning
- Standard 5° pre-travel and 90° total travel
- 24 – 120V AC/DC LED and 120V AC neon indicating lights available
- Rotary heads are field convertible CW, CCW, or both, without special tools
- Epoxy filled, pin connector or pigtail pin connector receptacles available

For Customer Service in the U.S. call 1-877-ETN CARE (386-2273), in Canada call 1-800-268-3578.

For Application Assistance in the U.S. and Canada call 1-800-426-9184.

August 2007

Model Selection — Assembled Switches — Standard

Assembled Switch	Single Pole (5 Terminal Receptacle)			Double Pole (9 Terminal Receptacle)					
	Indicating Light:	None	LED (24 – 120V AC/DC)	Neon (120V AC)	None	LED (24 – 120V AC/DC)	Neon (120V AC)	LED (24 – 120V AC/DC)	Neon (120V AC)
Switch Body:	E50SA 1N.O.-1N.C.	E50SAL 1N.O.-1N.C.	E50SAN 1N.O.-1N.C.	E50SB 2N.O.-2N.C.	E50SBL 2N.O.-2N.C.	E50SBN 2N.O.-2N.C.	E50SCL 1N.O.-2N.C.	—	
Receptacle: ①	E50RA	E50RA	E50RA	E50RB	E50RB	E50RB	E50RB	E50RB	
Operating Head Type ②		Catalog Number for Assembled Switches (Head + Receptacle + Body)							
Side Rotary (requires an operating lever, see PG.05C.04.T.E)	Standard Spring Return — E50DR1 ③	E50AR1	E50ALR1	E50ANR1	E50BR1	E50BLR1	E50BNR1	—	—
	Low Force Spring Return — E50DL1 ③	E50AL1	E50ALL1	E50ANL1	E50BL1	E50BLL1	E50BNL1	—	—
	Maintained Two-Position — E50DM1	E50AM1	E50ALM1	E50ANM1	E50BM1	E50BLM1	E50BNM1	—	—
Side Pushbutton, Spring Return — E50DS1		E50AS1	E50ALS1	E50ANS1	E50BS1	E50BLS1	E50BNS1	E50CLS1	—
Side Pushbutton, Adjustable Spring Return — E50DS2		E50AS2	E50ALS2	E50ANS2	E50BS2	E50BLS2	E50BNS2	E50BLS2	E50CNS2
Side Push Roller, Spring Return — E50DS3 ④		E50AS3	E50ALS3	E50ANS3	E50BS3	E50BLS3	E50BNS3	E50BLS3	—
Side Pushbutton, Maintained — E50DH1		E50AH1	E50ALH1	E50ANH1	E50BH1	E50BLH1	E50BNH1	E50BLH1	—
Wiring:		Single Pole 1N.O.-1N.C. Must be same polarity			Double Pole 2N.O.-2N.C. Parallel wired Indicator light Same polarity each pole			Double Pole 1N.O.-2N.C. Series wired Indicator light; Same polarity each pole	

① Connection options (add the Code Suffix from the table below to the end of the Catalog Number):

Option	Mating Cordset Catalog Number	Code Suffix
Mini-Connector ⑤ (with epoxy filled receptacle)	Single Pole (5-Pin Mini-Connector)	CSMS5D5CY1602
	Double Pole (9-pin Mini-Connector)	CSMS9D9CY1602
Micro-Connector ⑤ (with epoxy filled receptacle)	Single Pole (5-Pin Micro-Connector)	CSDS5A5CY2202
Cable Connection (with epoxy filled receptacle)	8-foot cable length	—
	12-foot cable length	—
	20-foot cable length	—
Manifold Mount (rear wiring entrance)	—	M
20 mm Conduit Entrance	—	20

② For Operating Head specifications, see Page 5.

③ CW (clockwise) and CCW (counterclockwise) operation, easily convertible to CW only or CCW only operation.

④ Roller can be converted in the field between horizontal and vertical.





⑤ For a full selection of cable connectors, see PG.05.05.T.E.







⑥ Refer to Page 7 for wiring diagram.

Fast turn product with typical one business day lead-time to shipment.

Stocked product, typical order quantities guaranteed in stock.

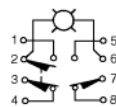

Model Selection — Assembled Switches — Standard (Continued)^①

	Single Pole (5 Terminal Receptacle)  			Double Pole (9 Terminal Receptacle)  					
	Indicating Light:	None	LED (24 – 120V AC/DC)	Neon (120V AC)	None	LED (24 – 120V AC/DC)	Neon (120V AC)	LED (24 – 120V AC/DC)	Neon (120V AC)
	Switch Body:	E50SA 1N.O.-1N.C.	E50SAL 1N.O.-1N.C.	E50SAN 1N.O.-1N.C.	E50SB 2N.O.-2N.C.	E50SBL 2N.O.-2N.C.	E50SBN 2N.O.-2N.C.	E50SCL 1N.O.-2N.C.	—
	Receptacle: ^①	E50RA	E50RA	E50RA	E50RB	E50RB	E50RB	E50RB	E50RB

Operating Head Type ^②		Catalog Number for Assembled Switches							
Top Pushbutton, Spring Return — E50DT1 	E50AT1	E50ALT1	E50ANT1	E50BT1	E50BLT1	E50BNT1	E50CLT1	E50BNT1	
Top Pushbutton, Adjustable Spring Return — E50DT2 	E50AT2	E50ALT2	E50ANT2	E50BT2	E50BLT2	E50BNT2	—	—	
Top Push Roller, Spring Return — E50DT3 ^③ 	E50AT3	E50ALT3	E50ANT3	E50BT3	E50BLT3	E50BNT3	—	—	
Wobble Head, Spring Return (requires a wobble operator, see PG.05C.04.T.E) 	Standard Duty — E50DW1	E50AW1	E50ALW1	E50ANW1	E50BW1	E50BLW1	E50BNW1	E50CLW1	—
	Heavy-Duty High Strength Steel — E50DW2	E50AW2	E50ALW2	E50ANW2	E50BW2	E50BLW2	E50BNW2	E50CLW2	E50BNW2
Wiring:	Single Pole 1N.O.-1N.C. Must be same polarity 			Double Pole 2N.O.-2N.C. Parallel wired Indicator light Same polarity each pole 			Double Pole 1N.O.-2N.C. Series wired Indicator light; Same polarity each pole 		





^① Connection options (add the Code Suffix from the table below to the end of the Catalog Number):

Option	Mating Cordset Catalog Number	Code Suffix
Mini-Connector ^④ (with epoxy filled receptacle)	Single Pole (5-Pin Mini-Connector)	CSMS5D5CY1602
	Double Pole (9-pin Mini-Connector)	CSMS9D9CY1602
Micro-Connector ^④ (with epoxy filled receptacle)	Single Pole (5-Pin Micro-Connector)	CSDS5A5CY2202
Cable Connection (with epoxy filled receptacle)	8-foot cable length	—
	12-foot cable length	—
	20-foot cable length	—
Manifold Mount (rear wiring entrance)	—	M
20 mm Conduit Entrance	—	20

- ^② For Operating Head specifications, see Page 5.
- ^③ Roller can be converted in the field between horizontal and vertical.
- ^④ For a full selection of cable connectors, see PG.05.05.T.E.
- ^⑤ Refer to Page 7 for wiring diagram.
- ^⑥ Refer to Page 7 for wiring diagram.
-  Fast turn product with typical one business day lead-time to shipment.
-  Stocked product, typical order quantities guaranteed in stock.

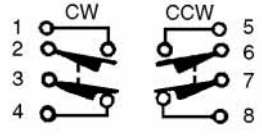
August 2007

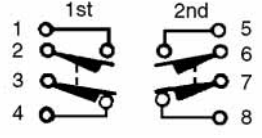
Model Selection — Assembled Switches — Special Purpose









	Operating Data — Nominal	Catalog Number				Circuit Diagram
		Assembled Switch	Switch Body Only	Receptacle Only	Operating Head Only	
Neutral Position (requires an operating lever, see PG.05C.04.T.E) 	5° Travel	E50NN1	E50SN	E50RB	E50DN1 ①	Same Polarity Each Pole 
	5° Travel; Stainless Steel Shaft	E50NN1SPL	—	—	—	
	15° Travel	E50NN2	E50SN	E50RB	E50DN2 ①	
	Travel to Operate Contacts: Travel to Reset Contacts: Total Travel: Force to Operate Contacts: Minimum Return Force: Operating Temperature:	5° or 15° (depending upon model selected) 2° 90° 1.8 in-lbs 2.5 in-oz 14° to 200°F (-10° to 94°C)				
Two Step CW, CCW or both, Convertible (requires an operating lever, see PG.05C.04.T.E) 		E50TD1	E50ST	E50RB	E50DD1	Same Polarity Each Pole 
	Travel to Operate Contacts: Travel to Reset Contacts: Total Travel: Force to Operate Contacts: Minimum Return Force: Operating Temperature:	1st Step 10°; 2nd Step 20° 4° Each 90° 3 in-lbs 4.5 in-oz CW or CCW: 14° to 250°F (-10° to 121°C) CW and CCW: 14° to 200°F (-10° to 94°C)				
Gravity Return (requires E50KL220, E50KL226 or equivalent operating lever, see PG.05C.04.T.E) 	Without Indicating Light	E50GG1	E50SG	E50RA	E50DG1	Must Be Same Polarity 
	With LED Indicating Light (24-120V AC/DC)	E50GLG1	E50SGL			
	With Neon Indicating Light (120V AC)	E50GNG1	E50SGN			
	Travel to Operate Contacts: Travel to Reset Contacts: Total Travel: Force to Operate Contacts: Minimum Return Force: Operating Temperature:	10° to 170° 8° 360° 3.0 in-oz Gravity 14° to 200°F (-10° to 94°C)				

① Add 9 suffix to the model number for low temperature (-40 to 79°C) versions.

Fast turn product with typical one business day lead-time to shipment.

Stocked product, typical order quantities guaranteed in stock.

Model Selection — Operating Heads

Description	Travel to Operate Contacts	Travel to Reset Contacts	Total Travel	Force to Operate Contacts	Minimum Return Force	Operating Temperature ^①		Catalog Number	
						Without Cable	With Pre-wired Cable		
Side Rotary (requires an operating lever, see PG.05C.04.T.E) 	Standard Spring Return ^②	5°	2°	90°	3 in-lbs	4.5 in-oz	10° to 200°F (-12° to 94°C) ^③	10° to 200°F (-12° to 94°C) ^③	E50DR1
	Low ^② Temperature Spring Return	5°	2°	90°	3 in-lbs	4.5 in-oz	-40° to 175°F (-40° to 79°C)	-31° to 175°F (-34° to 79°C)	E50DR19
	Low Force Spring Return ^②	15°	6°	90°	1.5 in-lbs	2.5 in-oz	10° to 200°F (-12° to 94°C) ^③	10° to 200°F (-12° to 94°C) ^③	E50DL1
	Maintained Two-Position	50°	50°	90°	3 in-lbs	—	14° to 200°F (-10° to 94°C)	14° to 200°F (-10° to 94°C)	E50DM1
Side Pushbutton, Spring Return 	0.065 inch	0.030 inch	0.250 inch	4 lbs	8 oz	14° to 200°F (-10° to 94°C)	14° to 200°F (-10° to 94°C)	E50DS1	
Side Pushbutton, Adjustable Spring Return 	0.065 inch	0.030 inch	0.250 inch	4 lbs	8 oz	14° to 200°F (-10° to 94°C)	14° to 200°F (-10° to 94°C)	E50DS2	
Side Push Roller, Spring Return ^④ 	0.065 inch	0.030 inch	0.250 inch	4 lbs	8 oz	14° to 200°F (-10° to 94°C)	14° to 200°F (-10° to 94°C)	E50DS3 ^⑤	
								E50DS4 ^⑤	
Side Pushbutton, Maintained 	0.200 inch	0.130 inch	0.320 inch	5 lbs	5 lbs	14° to 200°F (-10° to 94°C)	14° to 200°F (-10° to 94°C)	E50DH1	
Top Pushbutton, Spring Return 	0.040 inch	0.020 inch	0.280 inch	4 lbs	8 oz	14° to 250°F (-10° to 121°C)	14° to 221°F (-10° to 105°C)	E50DT1	
Top Pushbutton, Adjustable Spring Return 	0.040 inch	0.020 inch	0.280 inch	4 lbs	8 oz	14° to 250°F (-10° to 121°C)	14° to 221°F (-10° to 105°C)	E50DT2	
Top Push Roller, Spring Return 	0.040 inch	0.020 inch	0.280 inch	4 lbs	8 oz	14° to 250°F (-10° to 121°C)	14° to 221°F (-10° to 105°C)	E50DT3	
Wobble Head, Spring Return (requires a wobble operator, see PG.05C.04.T.E) 	Standard Duty	10°	6°	15°	2 in-lbs	2.4 in-oz	14° to 250°F (-10° to 121°C)	14° to 221°F (-10° to 105°C)	E50DW1
	Heavy-Duty High Strength Steel	10°	6°	15°	2 in-lbs	2.4 in-oz	14° to 250°F (-10° to 121°C)	14° to 221°F (-10° to 105°C)	E50DW2

^① Temperature ranges below +32°F (0°C) are based on absence of freezing moisture or water.

^② CW (clockwise) and CCW (counterclockwise) operation, easily convertible to CW only or CCW only operation.

^③ For CW and CCW operation. For CW only or CCW only operation, high temperature limit increases to 250°F (121°C) without cable, and 221°F (105°C) with pre-wired cable.

^④ Roller can be converted in the field between horizontal and vertical.

^⑤ Roller shaft is 0.38 inches (9.5 mm) longer on E50DS4, see dimensions on **Page 11**.

 Stocked product, typical order quantities guaranteed in stock.

August 2007

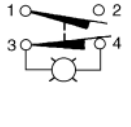
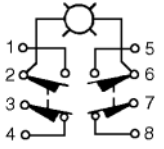
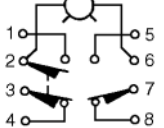

Model Selection — Switch Bodies

	Circuit	Switch Body Construction	Catalog Number
	Single Pole 1N.O.-1N.C. Must Be Same Polarity ① 	Without Indicating Light	E50SA CE
		With LED Indicating Light 24 – 120V AC/DC	E50SAL
		With Neon Indicating Light 120V AC	E50SAN
	Double Pole 2N.O.-2N.C. Parallel Wired Ind. Light Same Polarity Each Pole 	Without Indicating Light	E50SB
		With LED Indicating Light 24 – 120V AC/DC	E50SBL
		With Neon Indicating Light 120V AC	E50SBN
Double Pole 2N.C.-1N.O. Series Wired Ind. Light Same Polarity Each Pole ① 	With LED Indicating Light 24 – 120V AC/DC	E50SCL	

① Indicating lights are supplied from the factory wired as shown. However, they can easily be re-connected to terminals 1 and 2 if necessary (SPDT).

- Fast turn product with typical one business day lead-time to shipment.
- Stocked product, typical order quantities guaranteed in stock.









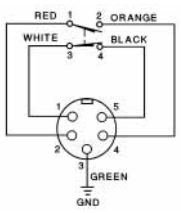

Model Selection — Receptacles

	Description	Poles	Conduit Entrance	Cable Length	Catalog Number	Wiring
Surface Mount 	Conduit entrance, front or rear mounting	Single Pole (5 Terminal)	1/2 NPT	—	E50RA	①
			20 mm	—	E50RA20	
		Double Pole (9 Terminal)	1/2 NPT	—	E50RB	①
			3/4 NPT	—	E50RB34	
Manifold Mount 	Rear wiring entrance instead of conduit hole, gasket on back for oil tightness	Single Pole (5 Terminal)	—	—	E50RAM	①
			Double Pole (9 Terminal)	—	—	

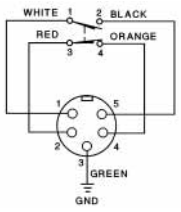
① See Model Selection — Switch Bodies for wiring information.

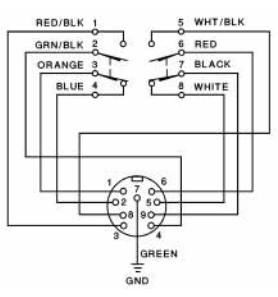
- Fast turn product with typical one business day lead-time to shipment.
- Stocked product, typical order quantities guaranteed in stock.

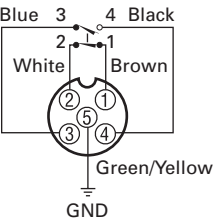
Model Selection — Receptacles (Continued)

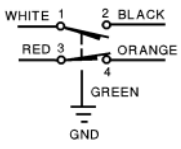
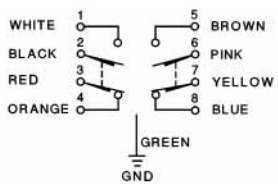
	Description	Poles	Conduit Entrance	Cable Length	Catalog Number	Wiring
	Epoxy filled receptacle with pre-wired Mini-Connector. (The -W version is a wiring scheme typically used in automotive applications.)	Single Pole (5 Terminal)	5-pin Mini-Connector	—	E50RAP5 	① 
					E50RAP5-W 	① 
		Double Pole (9 Terminal)	9-pin Mini-Connector	—	E50RBP9 	① 
	Epoxy filled receptacle with pre-wired Mini-Connector.	Single Pole (5 Terminal)	—	—	E50RAA5	
	Epoxy filled receptacle with pre-wired 16 gauge, yellow jacketed, type SOOW-A cable. Cable enters through hole threaded for conduit	Single Pole (5 Terminal)	1/2 NPT	8-foot	E50RAS	① 
				12-foot	E50RAS12	
				20-foot	E50RAS20	
				20 mm	E50RA20S	
				20-foot	E50RA20S20	
		Double Pole (9 Terminal)	1/2 NPT	8-foot	E50RBS	① 
				12-foot	E50RBS12	
				20-foot	E50RBS20	
				20 mm	E50RB20S	
				20-foot	E50RB20S20	





① The wire colors referenced on these diagrams are those internal to the switch itself.

 See listing of compatible connector cables on **Page 8**.

 Stocked product, typical order quantities guaranteed in stock.

August 2007

Model Selection — Compatible Connector Cables ①

	Voltage Style	Number of Pins	Gauge	Length	Catalog Number	Pin Configuration/Wire Colors (Face View Female Shown)
Standard Cables — Mini Style						
 Mini Style Straight Female Current Rating @ 600V 5-pin: 8A 9-pin: 7A	—	5-pin	16 AWG	6 feet (2m)	CSMS5D5CY1602	 1-White 2-Red 3-Green 4-Orange 5-Black
	—	9-pin	16 AWG	12 feet (4m)	CSMS9D9CY1602	 1-Orange 2-Blue 3-Red/Black 4-Green/Black 5-White 6-Red 7-Green 8-White/Black 9-Black
 Micro Style	—	5-pin 5-wire	22 AWG	6.0 feet (2m)	CSDS5A5CY2202	 1-Brown 2-White 3-Blue 4-Black 5-Green/Yellow

① For a full selection of connector cables, see **PG.05.05.T.E.**

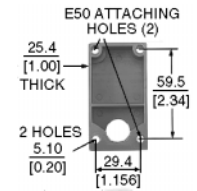
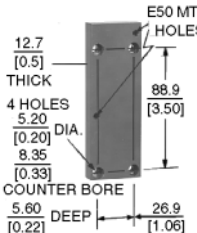
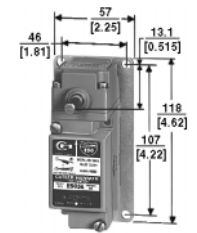
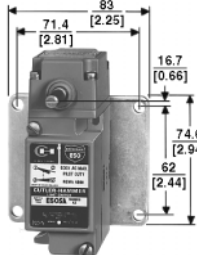

■ Stocked product, typical order quantities guaranteed in stock.

Model Selection — Accessories

Approximate Dimensions in mm [Inches]	Description	Catalog Number
 E50 ATTACHING HOLES (2) 25.4 [1.00] THICK 59.5 [2.34] 2 HOLES 5.10 [0.20] DIA. 29.4 [1.156]	Allows E50 to replace Eaton's Cutler-Hammer 10316 Type LP Surface Mounting Plug-In Limit Switch	E50KH1
	Allows E50 to replace Eaton's Cutler-Hammer 10316 Type LP Manifold Mounting Plug-In Limit Switch	E50KH1M
 12.7 [0.5] THICK 4 HOLES 5.20 [0.20] DIA. 8.35 [0.33] COUNTER BORE 5.60 DEEP [0.22] 26.9 [1.06] 88.9 [3.50] E50 MTG HOLES	Allows E50 to replace Square D Type AW Surface Mounting Non Plug-In Standard Box Limit Switch	E50KH7
 46 [1.81] 57 [2.25] 13.1 [0.515] 118 [4.62] 107 [4.22]	Allows E50 to replace National Acme, Type D-1200M, Style 2 Mounting. Denison LoxSwitch, Model L-100W, Style 2 Mounting. Square D 9007 Type T, Style B Mounting. (Adapter plate is 1/8 inch thick, with 1/4 inch mounting holes.)	E50KH4 ①
 71.4 [2.81] 83 [2.25] 16.7 [0.66] 74.6 [2.94] 62 [2.44]	Allows E50 to replace National Acme, Type D-1200M, Style 1 Mounting. Denison LoxSwitch, Model L-100W, Style 1 Mounting. Square D 9007 Type T, Style C Mounting. (Adapter plate is 1/8 inch thick, with 1/4 inch mounting holes.)	E50KH5 ①

① Limit Switch not included.

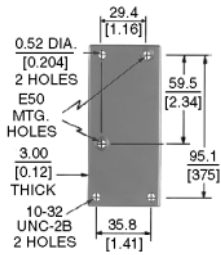
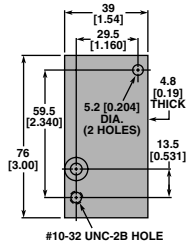
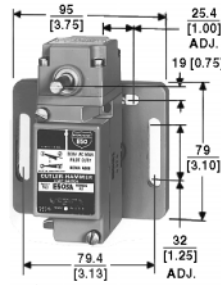
Model Selection — Accessories (Continued)

Approximate Dimensions in mm [Inches]	Description	Catalog Number
<p>Adapter Plate</p> 	Allows E50 to replace Eaton's Cutler-Hammer 10316 Type LT Non Plug-In 2-Pole Limit Switch	E50KH2
<p>Adapter Plate</p> 	Allows E50 to replace Allen-Bradley 802M Sealed Limit Switch	E50KH10
<p>Adjustable Mounting Plate</p> 	This is a mounting plate only 5/16 inch thick and includes the proper mounting bolts and nuts. The slots in the plate allow a maximum horizontal adjustment of 1 inch and vertical adjustment of 1-1/4 inches	E50KH3 ①
<p>Conduit Sealing Nut</p> 	1/2 inch oiltight	E50KH6

① Limit Switch not included.

■ Stocked product, typical order quantities guaranteed in stock.

August 2007

Specifications

Description	Specification
Environmental Ratings	NEMA 1, 3, 3S, 4, 4X, 6, 6P, 13, IP67
Material of Construction	Zinc die cast
Switch Gasket Material	Viton [®]
Universal U.S./DIN Mounting Dimensions	1.16 in (30 mm) x 2.34 in (60 mm)
Conduit Entrance	1/2 in NPT or 20 mm threading
Contact Ratings	See below
Contact Operation	Snap action over center mechanism
Contact Material	Fine silver
Maximum Frequency of Operation	8000 operations per hour
Mechanical Life: Side Rotary Side or Top Push	13,000,000 operations minimum 10,000,000 operations minimum
Electrical Life: Single Pole Double Pole	1,000,000 operations typical at full load 100,000 operations typical at full load
Ambient Temperature Range — Standard Standard without Cable Standard with Cable Low Temperature without Cable Low Temperature with Cable	14° to 250°F (-10° to 121°C) 14° to 221°F (-10° to 105°C) -40° to 250°F (-40° to 121°C) -40° to 221°F (-40° to 105°C)
Repeat Accuracy — Standard Side Operated Top Operated Side Rotary	Within 0.0012 in Within 0.0003 in Within 0.0014 in
Torque Requirements: Switch Body Screws Operating Head Screws	25 – 30 lb-in 14 – 18 lb-in
Wire Size	Will accept AWG #22 – #12, single or stranded wire

Electrical Data — Maximum Contact Ratings (Same polarity each pole)

AC Volts	Current, Amperes			Voltamperes		DC Volts	Current, Amperes	
	Make	Break	Cont. ①	Make	Break		Max. Make or Break	Cont. ①

All Switches Except Gravity Return and Indicating Light Versions

NEMA A600 Rating						NEMA R300		
120	60	6	10	7200	720	125	0.22	1.0
240	30	3				250	0.11	1.0
480	15	1.5						
600	12	1.2						

Switches with Indicating Lights (LED or Neon)

NEMA A150 Rating						NEMA R150		
120	60	6	10	7200	720	125	0.22	1.0

Gravity Return Switches — Maximum Contact Ratings

NEMA 6600 Rating — Contacts on Same Polarity						—		
120	30	3	5	3600	360	—	—	—
240	15	1.5						
480	7.5	0.75						
600	6	0.60						

① Thermal rating. Valid only if switch does not have to make or break.

Approximate Dimensions in Inches (mm)

Standard

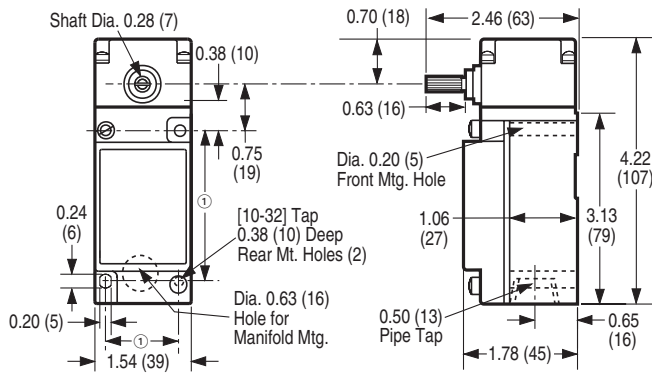

E50SB34

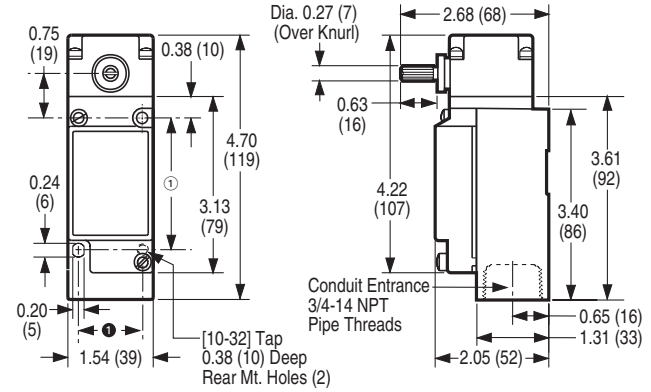

① Can accommodate both U.S., 1.16 (29.4) x 2.34 (59.5) and DIN, 1.18 (30) x 3.26 (60), mounting dimensions.

Side Push Operators in mm [Inches]

Pushbutton

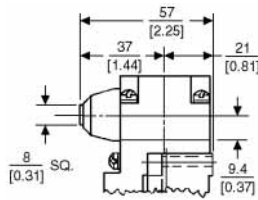

Top Push Operators in mm [Inches]

Pushbutton

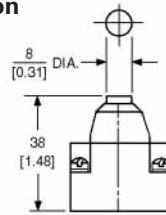

Wobble Operators

See Operators, PG.05C.04.T.E

Adjustable Pushbutton

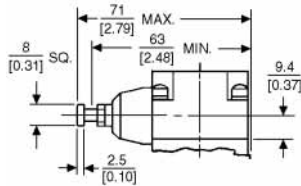

Adjustable Pushbutton

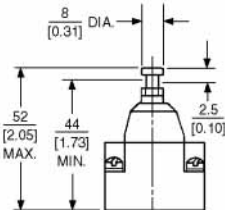

Roller

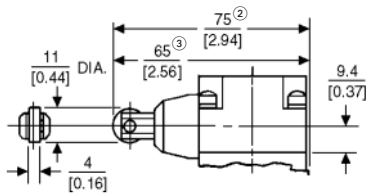

② For E50DS4.
③ For E50DS3.

Roller

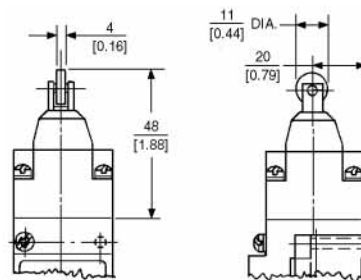

Maintained Pushbutton

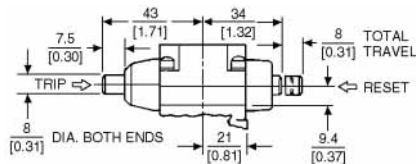

Limit Switch Operators

Finalize Your Limit Switch Installation with Right Operator for the Job

Contents

- Overview 1
- Model Selection, Roller Type 1
- Model Selection, Rod Type 4
- Model Selection, Wobble Type 7

The Cutler-Hammer® Operators presented here are used with Eaton's E50 Plug-In and 6P+ limit switches, as well as our 10316 rotary type limit switches. A wide variety of styles and sizes are available to provide optimum performance for nearly any application.





Unless otherwise noted, the products contained in this document are not designed or intended for use in human safety applications.

Product Features

- Wide variety of operator types for rotary and wobble style limit switches
- Rollers and rods available in metal and nonmetal contact surfaces

Model Selection — Roller Type Operators (for Rotary Head Switches: E50 Plug-In, E50 6P+, and 10316)

NOTE: Only operators with Nylatron rods or rollers should be used with explosion-proof limit switches.

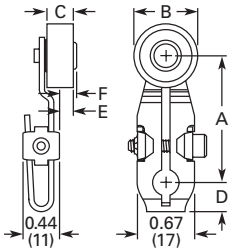
	Approximate Dimensions in Inches (mm)						Roller Type	Minimum Required Return Torque ^②	Catalog Number	Dimension Drawing	
	A — Lever Length ^①	B — Roller Diameter	C — Roller Width	D	E	F					
 E50KL200  E50KL355  E50KL377	0.88 (22.2)	0.75 (19.0)	0.32 (8.1)	0.31 (7.9)	0.20 (5.1)	0.24 (6.1)	Metal	0.62 in-oz	E50KL39		
	1.38 (34.9)	0.75 (19.0)	0.32 (8.1)	0.34 (8.6)	0.13 (3.3)	0.17 (4.3)	Metal	0.95 in-oz	E50KL40		
	1.50 (38.1)	0.69 (17.5)	0.25 (6.4)	0.34 (8.6)	0.05 (1.3)	0.11 (2.8)	Ball Bearing	0.77 in-oz	E50KL531		
			0.75 (19.0)	0.32 (8.1)	0.34 (8.6)	0.13 (3.3)	0.17 (4.3)	Nylatron	0.53 in-oz		E50KL200
			—	—	0.34 (8.6)	—	—	Metal	1.10 in-oz		E50KL355
	2.00 (50.8)	0.69 (17.5)	1.00 (25.4)	0.34 (8.6)	0.83 (21.1)	0.83 (21.1)	Nylatron	0.96 in-oz	E50KL377		
			—	—	0.34 (8.6)	—	—	Without Roller	0.32 in-oz		E50KL32
			0.75 (19.0)	0.32 (8.1)	0.34 (8.6)	0.13 (3.3)	0.17 (4.3)	Ball Bearing	1.10 in-oz		E50KL552
			—	—	0.34 (8.6)	0.13 (3.3)	0.17 (4.3)	Nylatron	0.71 in-oz		E50KL546
	—	—	—	0.34 (8.6)	0.83 (21.1)	0.83 (21.1)	Metal	1.50 in-oz	E50KL549		
Nylatron							1.45 in-oz	E50KL572			

① Length from the operating shaft axis to the roller axis (or to the tip for non-roller operators).

② **Caution:** When selecting lever, the minimum required return torque of lever should not exceed minimum return force available in operating head as given in Operating Head specifications.



■ Stocked product, typical order quantities guaranteed in stock.

For Customer Service in the U.S. call **1-877-ETN CARE (386-2273)**,
 in Canada call **1-800-268-3578**.
 For Application Assistance in the U.S. and Canada
 call **1-800-426-9184**.

August 2007

Model Selection — Roller Type Operators (for Rotary Head Switches: E50 Plug-In, E50 6P+, and 10316) (Continued)

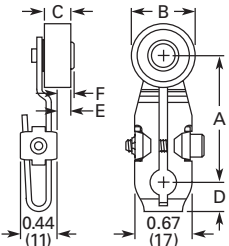
NOTE: Only operators with Nylatron rods or rollers should be used with explosion-proof limit switches.

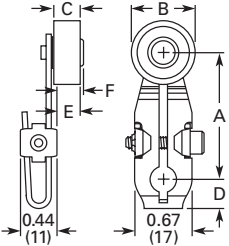
	Approximate Dimensions in Inches (mm)						Roller Type	Minimum Required Return Torque ^②	Catalog Number	Approximate Dimensions in mm [Inches]
	A—Lever Length ^①	B—Roller Diameter	C—Roller Width	D	E	F				
Standard Roller (Stainless Steel) 	2.50 (63.5)	0.69 (17.5)	0.25 (6.4)	0.34 (8.6)	0.05 (1.3)	0.11 (2.8)	Ball Bearing	1.50 in-oz	E50KL553	
		0.75 (19.0)	0.32 (8.1)	0.34 (8.6)	0.13 (3.3)	0.17 (4.3)	Nylatron	1.00 in-oz	E50KL547	
							Metal	2.00 in-oz	E50KL550	
		1.00 (25.4)	0.34 (8.6)	0.83 (21.1)	0.83 (21.1)	Nylatron	1.80 in-oz	E50KL573		
	1.50 (38.1)	0.28 (7.1)	0.34 (8.6)	0.11 (2.8)	0.17 (4.3)	Nylatron	1.40 in-oz	E50KL575		
	3.00 (76.2)	0.69 (17.5)	0.25 (6.4)	0.34 (8.6)	0.05 (1.3)	0.11 (2.8)	Ball Bearing	1.80 in-oz	E50KL554	
		0.75 (19.0)	0.32 (8.1)	0.34 (8.6)	0.13 (3.3)	0.17 (4.3)	Nylatron	1.30 in-oz	E50KL548	
							Metal	2.50 in-oz	E50KL551	
		1.00 (25.4)	0.34 (8.6)	0.83 (21.1)	0.83 (21.1)	Nylatron	2.30 in-oz	E50KL574		
	1.50 (38.1)	0.28 (7.1)	0.34 (8.6)	0.11 (2.8)	0.17 (4.3)	Nylatron	1.80 in-oz	E50KL576		
Roller on Reverse Side (Stainless Steel) 	1.50 (38.1)	0.69 (17.5)	0.25 (6.4)	0.34 (8.6)	0.18 (4.6)	0.24 (6.1)	Ball Bearing	0.77 in-oz	E50KL580	
		0.75 (19.0)	0.32 (8.1)	0.34 (8.6)	0.27 (6.9)	0.31 (7.9)	Nylatron	0.53 in-oz	E50KL310	
							Metal	1.10 in-oz	E50KL579	
		1.50 (38.1)	0.28 (7.1)	0.34 (8.6)	0.23 (5.8)	0.31 (7.9)	Nylatron	0.96 in-oz	E50KL536	

① Length from the operating shaft axis to the roller axis (or to the tip for non-roller operators).

② **Caution:** When selecting lever, the minimum required return torque of lever should not exceed minimum return force available in operating head as given in Operating Head specifications.

Fast turn product with typical one business day lead-time to shipment.

Stocked product, typical order quantities guaranteed in stock.

Model Selection — Roller Type Operators (for Rotary Head Switches: E50 Plug-In, E50 6P+, and 10316) (Continued)

NOTE: Only operators with Nylatron rods or rollers should be used with explosion-proof limit switches.

	Approximate Dimensions in Inches (mm)						Roller Type	Minimum Required Return Torque ^②	Catalog Number	Approximate Dimensions in mm [Inches]	
	A — Lever Length ^①	B — Roller Diameter	C — Roller Width	D	E	F					
 Offset Inboard Roller (Stainless Steel)	1.50 (38.1)	0.75 (19.0)	0.32 (8.1)	0.03 (0.8)	—	—	Nylatron	0.65 in-oz	E50KL24		
		0.69 (17.5)	0.25 (6.4)	0.04 (1.0)	—	—	Ball Bearing	0.90 in-oz			E50KL26
		0.75 (19.0)	0.32 (8.1)	0.03 (0.8)	—	—	Metal	1.20 in-oz	E50KL25		
 Offset Outboard Roller (Stainless Steel)	1.50 (38.1)	0.75 (19.0)	0.32 (8.1)	0.03 (0.8)	—	—	Nylatron	0.65 in-oz	E50KL27		
		0.69 (17.5)	0.25 (6.4)	0.04 (1.0)	—	—	Ball Bearing	0.90 in-oz	E50KL29		
		0.75 (19.0)	1.00 (25.4)	—	—	—	Nylatron	1.10 in-oz	E50KL30		
 Bantam Lever	0.69 (17.5)	0.85 (22)	0.18 (4.6)	—	—	—	Metal	0.45 in-oz	E50KL532		
 Precision Adjustment	0.69 (17.5) Roller Length: 1.50 (38.1) ^③	0.75 (19.0)	0.32 (8.1)	0.48 (12.2)	0.24 (6.1)	0.28 (7.1)	Nylatron	0.65 in-oz	E50KL340		
		0.69 (17.5)	0.25 (6.4)	0.48 (12.2)	0.16 (4.1)	0.22 (5.6)	Ball Bearing	0.90 in-oz	E50KL535		
		0.69 (17.5)	0.25 (6.4)	0.48 (12.2)	0.16 (4.1)	0.22 (5.6)	Ball Bearing	0.90 in-oz	E50KL535		
 Adjustable Roller (Stainless Steel)	1.0 (25.4) to 3.75 (95.2) ^④	0.69 (17.5)	0.25 (6.4)	0.23 (5.8)	0.30 (7.6)	—	Ball Bearing	2.50 in-oz ^⑤	E50KL539		
		0.75 (19.0)	0.32 (8.1)	0.29 (7.4)	0.33 (8.4)	—	Nylatron	1.90 in-oz ^⑤	E50KL201		
		0.50 (12.7)	0.46 (11.6)	0.48 (12.2)	—	—	Nylatron	1.90 in-oz ^⑤	E50KL599		
		1.00 (25.4)	0.90 (22.9)	0.95 (24.1)	—	—	Nylatron	3.10 in-oz ^⑤	E50KL537		
		0.5 (12.7) to 3.25 (82.6)	4.0 (102)	0.11 (2.8)	0.11 (2.8)	0.19 (4.8)	—	Large Nylatron	4.50 in-oz ^⑤		E50KL598
		0.5 (12.7) to 3.75 (95.2)	—	—	—	—	—	Without Roller	1.20 in-oz ^⑤		E50KL31
		1.63 (41.3) to 3.75 (95.2) ^④	1.5 (38.1)	0.29 (7.4)	0.26 (6.6)	0.32 (8.1)	—	Nylatron	2.50 in-oz ^⑤		E50KL443

① Length from the operating shaft axis to the roller axis (or to the tip for non-roller operators).

② **Caution:** When selecting lever, the minimum required return torque of lever should not exceed minimum return force available in operating head as given in Operating Head specifications.

③ Maximum length dimension between operating shaft axis to the roller axis for comparison. Precision adjustable to lesser dimensions.

④ By reassembling lever, minimum length can be reduced another 12.7 mm (0.5 inch).

⑤ Applies when lever is extended to the maximum dimension.

⑥ High-Grade Stainless Steel.



Fast turn product with typical one business day lead-time to shipment.

Stocked product, typical order quantities guaranteed in stock.

August 2007

Model Selection — Roller Type Operators (for Rotary Head Switches: E50 Plug-In, E50 6P+, and 10316) (Continued)

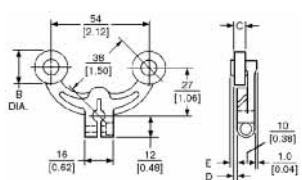
NOTE: Only operators with Nylatron rods or rollers should be used with explosion-proof limit switches.

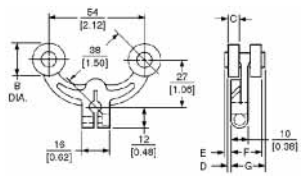
	Approximate Dimensions in Inches (mm)						Roller Type	Minimum Required Return Torque ^②	Catalog Number	Approximate Dimensions in mm [Inches]	
	A — Lever Length ^①	B — Roller Diameter	C — Roller Width	D	E	F					
	1.50 (38.1)	0.69 (17.5)	0.25 (6.4)	0.08 (2.0)	0.14 (3.6)	—	Ball Bearing	—			
		0.75 (19.0)	0.32 (8.1)	0.16 (4.1)	0.20 (5.1)	—	Nylatron	—		E50KL204	
		—	—	—	—	—	—	Metal		—	E50KL544
		—	—	1.00 (25.4)	0.84 (21.3)	0.88 (22.4)	—	Nylatron		—	E50KL543
	1.50 (38.1)	0.69 (17.5)	0.25 (6.4)	0.08 (2.0)	0.14 (3.6)	0.64 (16.3) G: 0.70 (17.8)	Ball Bearing	—			
		0.75 (19.0)	0.32 (8.1)	0.16 (4.1)	0.20 (5.1)	0.73 (18.5) G: 0.77 (19.6)	Nylatron	—		E50KL203	
		—	—	—	—	—	—	Metal		—	E50KL541

① Length from the operating shaft axis to the roller axis (or to the tip for non-roller operators).

② **Caution:** When selecting lever, the minimum required return torque of lever should not exceed minimum return force available in operating head as given in Operating Head specifications.

Fast turn product with typical one business day lead-time to shipment.

Stocked product, typical order quantities guaranteed in stock.

Model Selection — Rod Type Operators (for Rotary Head Switches: E50 Plug-In, E50 6P+, and 10316)

NOTE: Only operators with Nylatron rods or rollers should be used with explosion-proof limit switches.

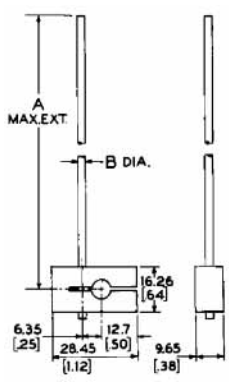
	Approximate Dimensions in Inches (mm)		Rod Type	Minimum Required Return Torque ^④	Catalog Number	Approximate Dimensions in mm [Inches]
	A — Rod Length ^③	B — Rod Diameter				
	5.5 (140) maximum	Rod Diameter: 0.19 (4.8)	Nylon	0.40 in-oz ^⑤	E50KL399	
		Rod Diameter: 0.12 (3.2)	Metal	0.92 in-oz ^⑤		
	8.75 (222) maximum	Rod Size (Square): 0.12 (3.2) x 0.12 (3.2)	Metal	2.20 in-oz ^⑤	E50KL581	
	9.0 (229) maximum	Rod Diameter: 0.19 (4.8)	Stainless Steel	7.00 in-oz ^⑤	E50KL220	
	12.0 (305) maximum	Rod Diameter: 0.12 (3.2)	Bendable Steel	5.00 in-oz ^⑤	E50KL226	
Clamps for Adjustable Rods (Rod not included)	—	Clamp for 0.19 (4.8) diameter rods	—	—	E50KL35	
	—	Clamp for 0.12 (3.2) diameter rods	—	—	E50KL36	
	—	Clamp for 0.25 (6.4) diameter rods	—	—	E50KL41	





③ Length from the operating shaft axis to tip.

④ **Caution:** When selecting lever, the minimum required return torque of lever should not exceed minimum return force available in operating head as given in Operating Head specifications.

⑤ Applies when lever is extended to the maximum dimension.

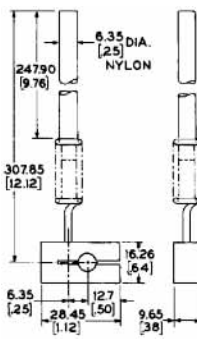
Stocked product, typical order quantities guaranteed in stock.

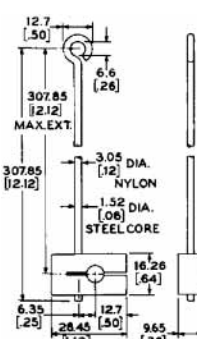
Model Selection — Rod Type Operators (for Rotary Head Switches: E50 Plug-In, E50 6P+, and 10316) (Continued)

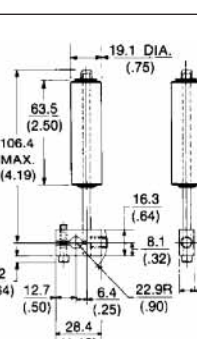
	Approximate Dimensions in Inches (mm)		Rod Type	Minimum Required Return Torque ^②	Catalog Number	Approximate Dimensions in mm [Inches]
	A — Rod Length ^①	B — Rod Diameter				
	12.12 (308)	Rod Diameter: 0.25 (6.4)	Nylon	3.50 in-oz	E50KL556	
	11.62 (295)	Rod Diameter: 0.09 (2.3)	Stainless Steel	2.80 in-oz		
	12.12 (308) maximum	0.50 (12.7) Diameter loop on wire end	Nylon Covered Wire	1.50 in-oz ^③	E50KL533	
	4.19 (106) maximum	Roller Diameter: 0.75 (19.0)	Nylatron	4.50 in-oz ^③	E50KL37	

^① Length from the operating shaft axis to tip.



^② **Caution:** When selecting lever, the minimum required return torque of lever should not exceed minimum return force available in operating head as given in Operating Head specifications.

^③ Applies when lever is extended to the maximum dimension.

 Stocked product, typical order quantities guaranteed in stock.

August 2007

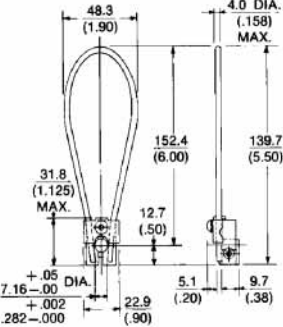
Model Selection — Rod Type Operators (for Rotary Head Switches: E50 Plug-In, E50 6P+, and 10316) (Continued)

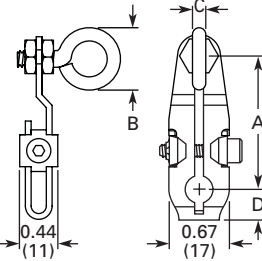



	Approximate Dimensions in Inches (mm)				Material	Minimum Required Return Torque ^②	Catalog Number	Approximate Dimensions in mm [Inches]
	A — Rod Length ^①	B — Rod Diameter	C	D				
	6.0 (152)	Ø: 0.158 (4.0)	—	—	Nylatron	0.40 in-oz	E50KL142	
	150 (38.1)	Ø: 0.1875 (4.8) Loop ID: 0.375 (9.5)	0.52 (13.1)	0.34 (8.6)	Zinc-Plated Steel	0.53 in-oz	E50KL33	

① Length from the operating shaft axis to tip.

② **Caution:** When selecting lever, the minimum required return torque of lever should not exceed minimum return force available in operating head as given in Operating Head specifications.

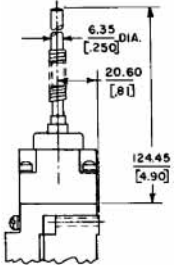
 Stocked product, typical order quantities guaranteed in stock.

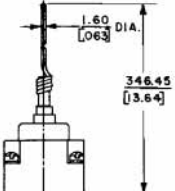
Model Selection — Wobble Type Operators
 (for E50DW1 Head on E50 Plug-In and E50 6P+ Switches)

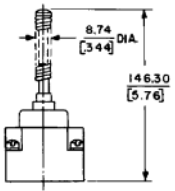
	Catalog Number	Approximate Dimensions in mm [Inches] (Shown with E50DW1 Wobble Head)
 <p>Nylon Rod</p>	E50KW2	
 <p>Stainless Steel Rod</p>	E50KW3	
 <p>Coil Spring</p>	E50KW4	

 Stocked product, typical order quantities guaranteed in stock.

August 2007

Heavy-Duty Factory Sealed 6P+ Switches

Contents

Overview 1
 Model Selection, Assembled Switches 2
 Model Selection, Operating Heads..... 4
 Model Selection, Switch Bodies..... 5
 Model Selection, Accessories..... 7
 Specifications..... 8
 Dimensions..... 9

Cutler-Hammer® E50 6P+ Limit Switches by Eaton's electrical business were specifically designed to withstand the penetrating properties of cutting fluids and coolants, such as those used in the automotive industry, as well as extreme shock, vibration and temperature fluctuations. The one-piece, epoxy filled switch body is prewired at the factory to ensure leak-proof, submersible performance. This unique construction positively stops fluid from finding its way to any and all critical connections.

Our 6P+ switches can be ordered in separate components or as complete assembled devices. They are available with prewired 16 AWG cables or mini-connectors. Standard and custom cable lengths are available. As part of the E50 line, the 6P+ switches use the same operating heads as the standard E50 plug-in models to reduce the components you need to inventory.

Approvals

- UL Listed
- CSA Certified
- IEC.947.5.1
- TUV — E9271605E02

CE (where shown)



Unless otherwise noted, the products contained in this document are not designed or intended for use in human safety applications.

The Best Sealed, Most Durable Limit Switch You Can Buy

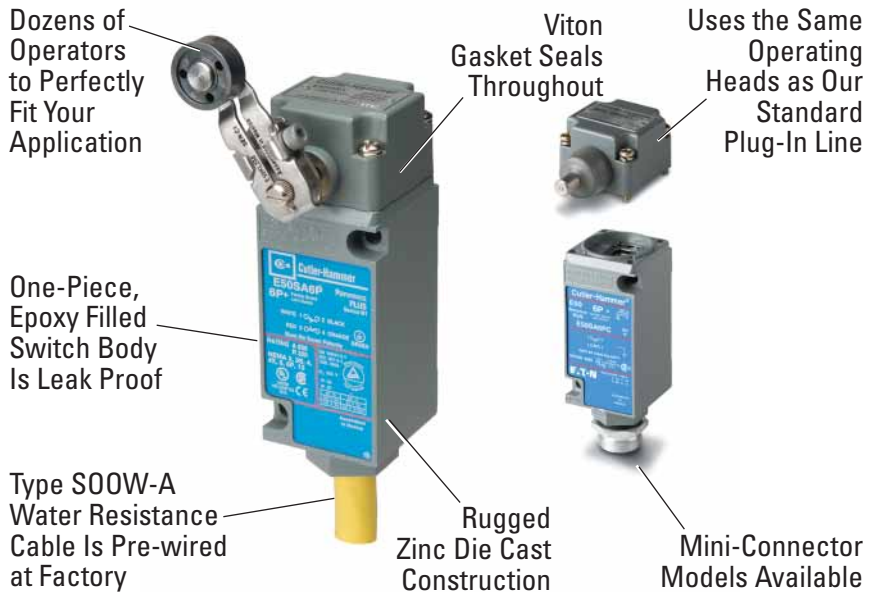







Product Features

- Manufactured to take the physical and environmental abuse (including cutting fluids and chemicals) of harsh industrial environments
- Modular, plug-in components (head and switch body) provide application flexibility, reduced inventory and less downtime
- Chemical resistant Viton gaskets, seals and boots are standard, and so are captive, posi-drive screws
- A special tertiary seal on the switch body prevents fluid from entering even when the operating head is not attached
- 600V rating, ridge-topped contacts and wiping action assure continuity even to logic level circuits
- Factory wired cable features a 350 pound pullout capacity
- Keyed, four direction head positioning. Standard 5° pre-travel and 90° total travel
- 24 – 120V AC/DC LED and 120V AC neon indicating lights available
- Rotary heads are field convertible CW, CCW, or both, without special tools
- Extended 5 year warranty

For Customer Service in the U.S. call 1-877-ETN CARE (386-2273), in Canada call 1-800-268-3578.
 For Application Assistance in the U.S. and Canada call 1-800-426-9184.

Model Selection — Assembled Switches — Standard (Connection is by 8-Foot Cable)①

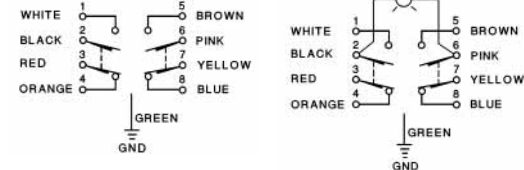
Assembled Switch 	Single Pole			Double Pole			
	None	LED (24 – 120V AC/DC)	Neon (120V AC)	None	LED (24 – 120V AC/DC)	Neon (120V AC)	
Lever Sold Separately	E50SA6P 1N.O.-1N.C.	E50SAL6P 1N.O.-1N.C.	E50SAN6P 1N.O.-1N.C.	E50SB6P 2N.O.-2N.C.	E50SBL6P 2N.O.-2N.C.	E50SBN6P 2N.O.-2N.C.	
Operating Head Type ②		Catalog Number for Assembled Switches					
Side Rotary (requires an operating lever, see PG.05C.04.T.E) 	Standard Spring Return — E50DR1 ③	E50AR16P CE	E50ALR16P	E50ANR16P	E50BR16P	E50BLR16P	E50BNR16P
	Low Force Spring Return — E50DL1 ③	E50AL16P CE	E50ALL16P	E50ANL16P	E50BL16P	E50BLL16P	E50BNL16P
	Maintained Two-Position — E50DM1	E50AM16P CE	E50ALM16P	E50ANM16P	E50BM16P	E50BLM16P	E50BNM16P
Side Pushbutton, Spring Return — E50DS1 	E50AS16P CE	E50ALS16P	E50ANS16P	E50BS16P	E50BLS16P	E50BNS16P	
Side Pushbutton, Adjustable Spring Return — E50DS2 	E50AS26P CE	E50ALS26P	E50ANS26P	E50BS26P	E50BLS26P	E50BNS26P	
Side Push Roller, Spring Return — E50DS3 ④ 	E50AS36P CE	E50ALS36P	E50ANS36P	E50BS36P	E50BLS36P	E50BNS36P	
Side Pushbutton, Maintained — E50DH1 	E50AH16P CE	E50ALH16P	E50ANH16P	E50BH16P	E50BLH16P	E50BNH16P	
Wiring:	Single Pole 1N.O.-1N.C. (Must be same polarity) 			Double Pole 2N.O.-2N.C. (Same polarity each pole) 			

① Connection options (add the Code Suffix from the table below to the end of the Catalog Number):

Option	Catalog Number	Code Suffix
Mini-Connector ⑥	Single Pole (5-Pin Mini-Connector)	CSMS5D5CY1602
	Double Pole (9-pin Mini-Connector)	CSMS9D9CY1602
Cable Connection	12-foot cable length (standard)	12
	20-foot cable length (standard)	20
	Other lengths (special order)	Length in Feet

② For Operating Head specifications, see Page 4.

③ CW (clockwise) and CCW (counterclockwise) operation, easily convertible to CW only or CCW only operation.

④ Roller can be converted in the field between horizontal and vertical.







⑤ For alternate wiring, use Code Suffix **CW**, see Page 6.

⑥ For a full selection of connector cables, see PG.05.05.T.E.

 Stocked product, typical order quantities guaranteed in stock.

August 2007

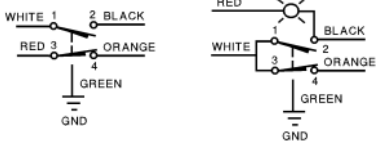
Model Selection — Assembled Switches — Standard (Connection is by 8-Foot Cable) (Continued)^①

 Assembled Switch Lever Sold Separately		Single Pole			Double Pole		
	Indicating Light:	None	LED (24 – 120V AC/DC)	Neon (120V AC)	None	LED (24 – 120V AC/DC)	Neon (120V AC)
	Switch Body:	E50SA6P 1N.O.-1N.C.	E50SAL6P 1N.O.-1N.C.	E50SAN6P 1N.O.-1N.C.	E50SB6P 2N.O.-2N.C.	E50SBL6P 2N.O.-2N.C.	E50SBN6P 2N.O.-2N.C.
Operating Head Type ^②		Catalog Number for Assembled Switches					
Top Pushbutton, Spring Return — E50DT1 		E50AT16P CE	E50ALT16P	E50ANT16P	E50BT16P	E50BLT16P	E50BNT16P
Top Pushbutton, Adjustable Spring Return — E50DT2 		E50AT26P CE	E50ALT26P	E50ANT26P	E50BT26P	E50BLT26P	E50BNT26P
Top Push Roller, Spring Return — E50DT3 		E50AT36P CE	E50ALT36P	E50ANT36P	E50BT36P	E50BLT36P	E50BNT36P
Wobble Head, Spring Return (requires a wobble operator, see PG.05C.04.T.E) 	Standard Duty — E50DW1	E50AW16P CE	E50ALW16P	E50ANW16P	E50BW16P	E50BLW16P	E50BNW16P
	Heavy-Duty High Strength Steel — E50DW2	E50AW26P CE	E50ALW26P	E50ANW26P	E50BW26P	E50BLW26P	E50BNW26P
Wiring:		Single Pole 1N.O.-1N.C. (Must be same polarity)			Double Pole 2N.O.-2N.C. (Same polarity each pole)		
							

^① Connection options (add the Code Suffix from the table below to the end of the Catalog Number):

Option	Catalog Number	Code Suffix
Mini-Connector ^④	Single Pole (5-Pin Mini-Connector)	CSMS5D5CY1602
	Double Pole (9-pin Mini-Connector)	CSMS9D9CY1602
Cable Connection	12-foot cable length (standard)	12
	20-foot cable length (standard)	20
	Other lengths (special order)	Length in Feet

^② For Operating Head specifications, see Page 4.

^③ For alternate wiring, use Code Suffix C-W, see Page 6.
^④ For a full selection of connector cables, see PG.05.05.T.E.

^⑤ For alternate wiring, use Code Suffix CW, see Page 6.

 Stocked product, typical order quantities guaranteed in stock.

Model Selection — Operating Heads

Description	Travel to Operate Contacts	Travel to Reset Contacts	Total Travel	Force to Operate Contacts	Minimum Return Force	Operating Temperature ^①		Catalog Number	
						Without Cable	With Pre-wired Cable		
Side Rotary (requires an operating lever, see PG.05C.04.T.E) 	Standard Spring Return ^②	5°	2°	90°	3 in-lbs	4.5 in-oz	10° to 200°F (-12° to 94°C) ^③	10° to 200°F (-12° to 94°C) ^③	E50DR1
	Low ^② Temperature Spring Return	5°	2°	90°	3 in-lbs	4.5 in-oz	-40° to 175°F (-40° to 79°C)	-31° to 175°F (-34° to 79°C)	E50DR19
	Low Force Spring Return ^②	15°	6°	90°	1.5 in-lbs	2.5 in-oz	10° to 200°F (-12° to 94°C) ^③	10° to 200°F (-12° to 94°C) ^③	E50DL1
	Maintained Two-Position	50°	50°	90°	3 in-lbs	—	14° to 200°F (-10° to 94°C)	14° to 200°F (-10° to 94°C)	E50DM1
Side Pushbutton, Spring Return 	0.065 inch	0.030 inch	0.250 inch	4 lbs	8 oz	14° to 200°F (-10° to 94°C)	14° to 200°F (-10° to 94°C)	E50DS1	
Side Pushbutton, Adjustable Spring Return 	0.065 inch	0.030 inch	0.250 inch	4 lbs	8 oz	14° to 200°F (-10° to 94°C)	14° to 200°F (-10° to 94°C)	E50DS2	
Side Push Roller, Spring Return ^④ 	0.065 inch	0.030 inch	0.250 inch	4 lbs	8 oz	14° to 200°F (-10° to 94°C)	14° to 200°F (-10° to 94°C)	E50DS3 ^⑤	
								E50DS4 ^⑤	
Side Pushbutton, Maintained 	0.200 inch	0.130 inch	0.320 inch	5 lbs	5 lbs	14° to 200°F (-10° to 94°C)	14° to 200°F (-10° to 94°C)	E50DH1	
Top Pushbutton, Spring Return 	0.040 inch	0.020 inch	0.280 inch	4 lbs	8 oz	14° to 250°F (-10° to 121°C)	14° to 221°F (-10° to 105°C)	E50DT1	
Top Pushbutton, Adjustable Spring Return 	0.040 inch	0.020 inch	0.280 inch	4 lbs	8 oz	14° to 250°F (-10° to 121°C)	14° to 221°F (-10° to 105°C)	E50DT2	
Top Push Roller, Spring Return 	0.040 inch	0.020 inch	0.280 inch	4 lbs	8 oz	14° to 250°F (-10° to 121°C)	14° to 221°F (-10° to 105°C)	E50DT3	
Wobble Head, Spring Return (requires a wobble operator, see PG.05C.04.T.E) 	Standard Duty	10°	6°	15°	2 in-lbs	2.4 in-oz	14° to 250°F (-10° to 121°C)	14° to 221°F (-10° to 105°C)	E50DW1
	Heavy-Duty High Strength Steel	10°	6°	15°	2 in-lbs	2.4 in-oz	14° to 250°F (-10° to 121°C)	14° to 221°F (-10° to 105°C)	E50DW2

① Temperature ranges below +32°F (0°C) are based on absence of freezing moisture or water.

② CW (clockwise) and CCW (counterclockwise) operation, easily convertible to CW only or CCW only operation.

③ For CW and CCW operation. For CW only or CCW only operation, high temperature limit increases to 250°F (121°C) without cable, and 221°F (105°C) with pre-wired cable.



④ Roller can be converted in the field between horizontal and vertical.

⑤ Roller shaft is 0.38 inches (9.5 mm) longer on E50DS4, see dimensions on **Page 9**.

 Stocked product, typical order quantities guaranteed in stock.

August 2007

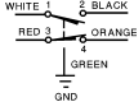
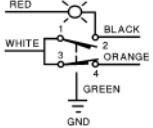
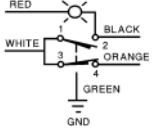
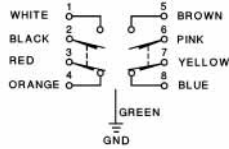
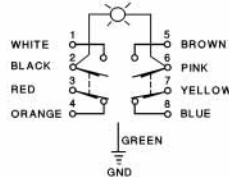
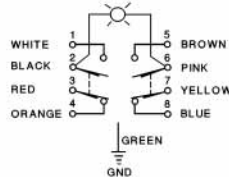
Model Selection — Switch Bodies

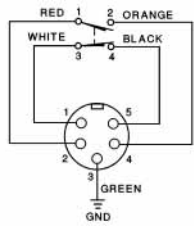
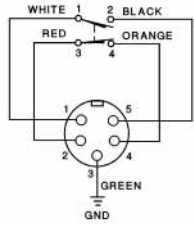
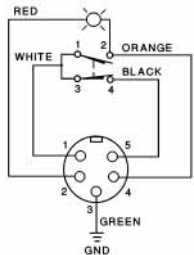
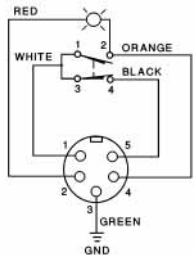
	Circuit	Switch Body Construction	Cable Length	Catalog Number	Wiring	
	Single Pole 1N.O.-1N.C.	Without Indicating Light	8-foot	E50SA6P		
			12-foot	E50SA6P12		
			20-foot	E50SA6P20		
		With LED Indicating Light 24–120V AC/DC	8-foot	E50SAL6P		
			12-foot	E50SAL6P12		
			20-foot	E50SAL6P20		
	With Neon Indicating Light 120V AC	8-foot	E50SAN6P			
		12-foot	E50SAN6P12			
		20-foot	E50SAN6P20			
	Double Pole 2N.O.-2N.C.	Without Indicating Light	Without Indicating Light	8-foot	E50SB6P	
				12-foot	E50SB6P12	
				20-foot	E50SB6P20	
With LED Indicating Light 24–120V AC/DC		Without Indicating Light	8-foot	E50SBL6P		
			12-foot	E50SBL6P12		
			20-foot	E50SBL6P20		
With Neon Indicating Light 120V AC	Without Indicating Light	8-foot	E50SBN6P			
		12-foot	E50SBN6P12			
		20-foot	E50SBN6P20			
	Single Pole 1N.O.-1N.C.	Without Indicating Light Normal Wiring	—	E50SA6PC Ⓢ	① 	
		Without Indicating Light Alternate Wiring	—	E50SA6PC-W Ⓢ	① 	
		With LED Indicating Light 24–120V AC/DC	—	E50SAL6PC Ⓢ	① 	
		With Neon Indicating Light 120V AC	—	E50SAN6PC Ⓢ	① 	

① The wire colors referenced on these diagrams are those internal to the switch itself.

Ⓢ See listing of compatible connector cables on **Page 6**.

 Fast turn product with typical one business day lead-time to shipment.

 Stocked product, typical order quantities guaranteed in stock.

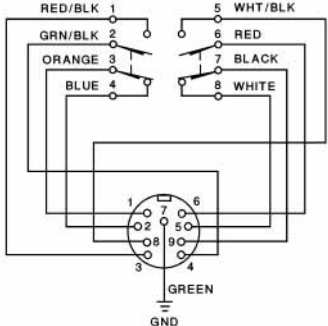
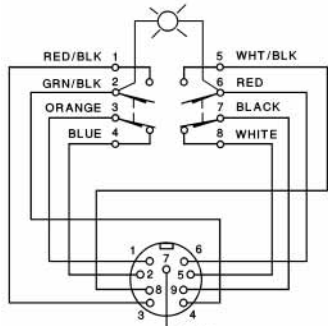
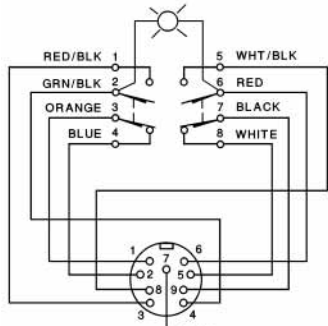

Model Selection — Switch Bodies (Continued)

	Circuit	Switch Body Construction	Cable Length	Catalog Number	Wiring
Mini-Connector 	Double Pole 2N.O.-2N.C.	Without Indicating Light	—	E50SB6PC	① 
		With LED Indicating Light 24 – 120V AC/DC	—	E50SBL6PC	① 
		With Neon Indicating Light 120V AC	—	E50SBN6PC	① 

① The wire colors referenced on these diagrams are those internal to the switch itself.

See listing of compatible connector cables below.

Model Selection — Compatible Connector Cables ②

	Voltage Style	Number of Pins	Gauge	Length	Catalog Number	Pin Configuration/Wire Colors (Face View Female Shown)
Standard Cables — Mini Style						
Mini Style Straight Female  Current Rating @ 600V 5-pin: 8A 9-pin: 7A	—	5-pin	16 AWG	6 feet (2m)	CSMS5D5CY1602	 1-White 2-Red 3-Green 4-Orange 5-Black
	—	9-pin	16 AWG	12 feet (4m)	CSMS9D9CY1602	 1-Orange 2-Blue 3-Red/Black 4-Green/Black 5-White 6-Red 7-Green 8-White/Black 9-Black

② For a full selection of connector cables, see **PG.05.05.T.E.**

Stocked product, typical order quantities guaranteed in stock.



August 2007

Model Selection — Accessories

Approximate Dimensions in mm [Inches]	Description	Catalog Number
<p>Adapter Plate</p>	<p>Allows E50 to replace Eaton's Cutler-Hammer 10316 Type LP Surface Mounting Plug-In Limit Switch</p>	E50KH1
<p>Adapter Plate</p>	<p>Allows E50 to replace Eaton's Cutler-Hammer 10316 Type LP Manifold Mounting Plug-In Limit Switch</p>	E50KH1M
<p>Adapter Plate</p>	<p>Allows E50 to replace National Acme, Type D-1200M, Style 2 Mounting. Denison LoxSwitch, Model L-100W, Style 2 Mounting. Square D 9007 Type T, Style B Mounting. (Adapter plate is 1/8 inch thick, with 1/4 inch mounting holes.)</p>	E50KH4 ①
<p>Adapter Plate</p>	<p>Allows E50 to replace National Acme, Type D-1200M, Style 1 Mounting. Denison LoxSwitch, Model L-100W, Style 1 Mounting. Square D 9007 Type T, Style C Mounting. (Adapter plate is 1/8 inch thick, with 1/4 inch mounting holes.)</p>	E50KH5 ①
<p>Adapter Plate</p>	<p>Allows E50 to replace Eaton's Cutler-Hammer 10316 Type LT Non Plug-In 2-Pole Limit Switch</p>	E50KH2
<p>Adapter Plate</p>	<p>Allows E50 to replace Allen-Bradley 802M Sealed Limit Switch</p>	E50KH10

① Limit Switch not included.

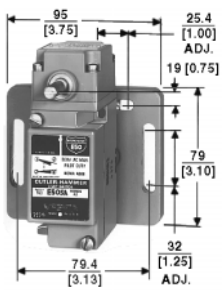
Model Selection — Accessories (Continued)

Approximate Dimensions in mm [Inches]	Description	Catalog Number
	This is a mounting plate only 5/16 inch thick and includes the proper mounting bolts and nuts. The slots in the plate allow a maximum horizontal adjustment of 1 inch and vertical adjustment of 1-1/4 inches	E50KH3 ^①
	1/2 inch oiltight	E50KH6

^① Limit Switch not included.

 Stocked product, typical order quantities guaranteed in stock.

Specifications

Environmental Ratings	NEMA 1, 3, 3S, 4, 4X, 6, 6P, 13, IP67
Material of Construction	Zinc die cast
Switch Gasket Material	Viton [®]
Universal U.S./DIN Mounting Dimensions	1.16 in (30 mm) x 2.34 in (60 mm)
Conduit Entrance	1/2 in NPT threading
Contact Ratings	See below
Contact Operation	Snap action over center mechanism
Contact Material	Fine silver
Maximum Frequency of Operation	8000 operations per hour
Mechanical Life:	
Side Rotary	13,000,000 operations minimum
Side or Top Push	10,000,000 operations minimum
Electrical Life:	
Single Pole	1,000,000 operations typical at full load
Double Pole	100,000 operations typical at full load
Ambient Temperature Range — Standard	
Standard without Cable	14° to 250°F (-10° to 121°C)
Standard with Cable	14° to 221°F (-10° to 105°C)
Low Temperature without Cable	-40° to 250°F (-40° to 121°C)
Low Temperature with Cable	-40° to 221°F (-40° to 105°C)
Repeat Accuracy — Standard	
Side Operated	Within 0.0012 in
Top Operated	Within 0.0003 in
Side Rotary	Within 0.0014 in
Torque Requirements:	
Operating Head Screws	14 – 18 lb-in

Electrical Data — Maximum Contact Ratings (Same polarity each pole)

AC Volts	Current, Amperes			Voltamperes		DC Volts	Current, Amperes	
	Make	Break	Cont. ^②	Make	Break		Max. Make or Break	Cont. ^②

All Switches Except Gravity Return and Indicating Light Versions

NEMA A600 Rating					NEMA R300			
120	60	6	10	7200	720	125	0.22	1.0
240	30	3				250	0.11	1.0
480	15	1.5						
600	12	1.2						

Switches with Indicating Lights (LED or Neon)

NEMA A150 Rating					NEMA R150			
120	60	6	10	7200	720	125	0.22	1.0

^② Thermal rating. Valid only if switch does not have to make or break.

August 2007

Approximate Dimensions in mm [Inches]

6P+ Limit Switch with Rotary Operating Head

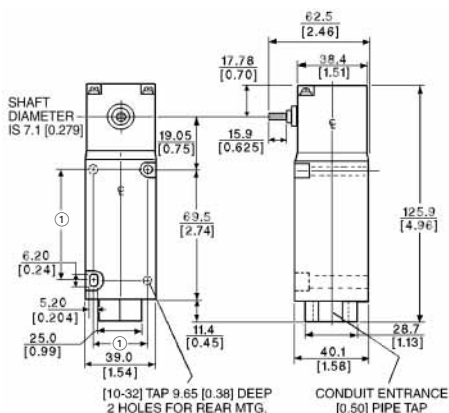

① Can accommodate both U.S., 29.4 (1.16) x 59.5 (2.34) and DIN, 30 (1.18) x 60 (3.26), mounting dimensions.

Side Push Operators

Pushbutton

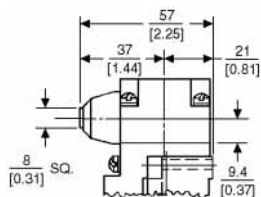

Top Push Operators

Pushbutton

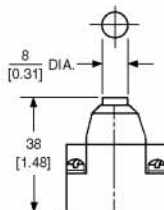

Wobble Operators

See Operators, PG.05C.04.T.E

Adjustable Pushbutton

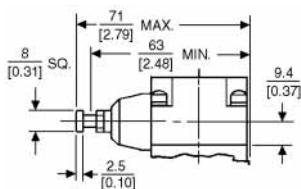

Adjustable Pushbutton

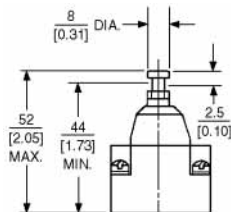

Roller

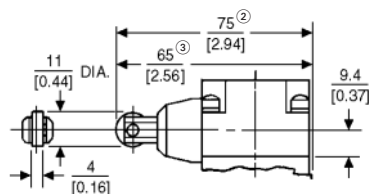

② For E50DS4.
③ For E50DS3.

Roller

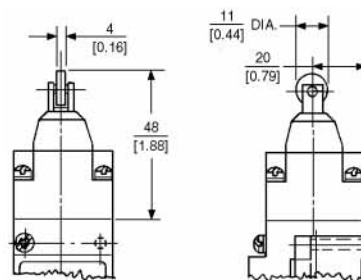

Maintained Pushbutton

