

Contents

<i>Description</i>	<i>Page</i>
Product Family Overview	
Product Description	33-78
Features	33-78
Standards and Certifications	33-78
Catalog Number Selection	33-79
Starters — 3-Phase Non-reversing and Reversing, Full Voltage, Bi-Metallic Overload	
Product Description	33-83
Features	33-83
Technical Data	33-84
Wiring Diagrams	33-84
Product Selection	33-85
Starters — 3-Phase Multispeed, Bi-Metallic Overload	
Product Selection	33-86
Starters — Single-Phase Non-reversing, Full Voltage, Bi-Metallic Overload	
Product Description	33-87
Wiring Diagrams	33-87
Product Selection	33-87
Starters — 3-Phase Non-reversing and Reversing, Full Voltage, C386 Electronic Overload	
Product Selection	33-88
Technical Data	
Product Selection	33-89
Accessories	
Auxiliary Contacts	33-96
DC Magnet Coils	33-98
Mounting Plates	33-99
Special Modifications	
Product Selection	33-100
Renewal Parts	
Product Selection	33-101
Dimensions	
Product Selection	33-104

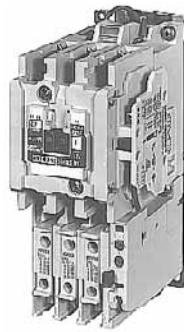

NEMA Size 1 — Cat. No. AN16DN0AB

Product Description

Non-reversing

Three-phase, full voltage magnetic starters are most commonly used to switch AC motor loads. Starters consist of a magnetically actuated switch (contactor) and an overload relay assembled together.

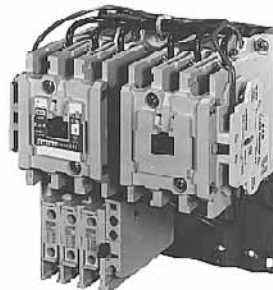

NEMA Size 1 — Cat. No. AN56DN0AB

Reversing

Three-phase, full voltage magnetic starters are used primarily for reversing of 3-phase squirrel cage motors. They consist of two contactors and a single overload relay assembled together. The contactors are mechanically and electrically interlocked to prevent line shorts and energization of both contactors simultaneously.

Features

- Bimetallic Ambient Compensated Overload relays — available in three basic sizes covering applications up to 900 hp — reducing number of different contactor/overload relay combinations that have to be stocked.

These overload relays feature:

- Selectable Manual or Automatic Reset operation.

- Interchangeable heater packs adjustable $\pm 24\%$ to match motor FLA and calibrated for 1.0 and 1.15 service factors. Heater packs for smaller overload relay will mount in larger overload relay — useful in derating applications such as jogging.
 - Load lugs built into relay base.
 - Single-phase protection, Class 20 or Class 10 trip time.
 - Overload trip indication.
 - Electrically isolated NO-NC contacts (pull RESET button to test).
 - The C396 is a self-powered, robust electronic overload designed for integrate use with Freedom NEMA contactors.
 - Tiered feature set to provide coverage specific to your application.
 - Broad 5:1 FLA range for maximum flexibility.
 - Coverage from 0.05 – 1500 Amps to meet all your needs.
 - Long life twin break, silver cadmium oxide contacts — provide excellent conductivity and superior resistance to welding and arc erosion. Generously sized for low resistance and cool operation.
 - Designed to 3,000,000 electrical operations at maximum hp ratings up through 25 hp at 600V.
 - Steel mounting plate standard on all open type starters.
 - Wired for separate or common control.
- #### Non-reversing
- Holding circuit contact(s) supplied as standard:
 - Sizes 00 – 3 have a NO auxiliary contact block mounted on right-hand side (on Size 00, contact occupies 4th power pole position — no increase in width).
 - Sizes 4 – 5 have a NO contact block mounted on left side.
 - Sizes 6 – 7 have a 2NO/2NC contact block on top left.
 - Size 8 has a NO/NC contact block on top left back and a NO on top right back.
- #### Reversing
- Each contactor (Size 00 – 8) supplied with one NO-NC side mounted contact block as standard. NC contacts are wired as electrical interlocks.

Starters — 3-Phase Non-reversing and Reversing, Full Voltage

Technical Data

Table 33-98. Wire (75°C) Sizes — AWG or kcmil — NEMA Sizes 00 – 2 — Open and Enclosed

NEMA Size	Wire Size ^② Cu Only
Power Terminals — Line	
00	12 – 16 AWG stranded, 12 – 14 AWG solid
0	8 – 16 AWG stranded, 10 – 14 AWG solid
1	8 – 14 AWG stranded or solid
2	3 – 14 AWG (upper) and/or 6 – 14 AWG (lower) stranded or solid ^①

Power Terminals — Load — Cu Only (stranded or solid)	
00 – 0	14 – 6 AWG stranded or solid
1 – 2	14 – 2 AWG stranded or solid

Control Terminals — Cu Only	
12 – 16 AWG stranded, 12 – 14 AWG solid	

- ① Two compartment box lug.
- ② Minimum per NEC. Maximum wire size: Sizes 00 and 0 to 8 AWG and Sizes 1 – 2 to 2 AWG.

Table 33-99. Wire (75°C) Sizes — AWG or kcmil — NEMA Sizes 3 – 8 — Open and Enclosed

NEMA Size	Wire Size ^③
Power Terminals — Line and Load	
3	1/0 – 14 AWG Cu/Al
4	Open — 3/0 – 8 AWG Cu; Enclosed — 250 kcmil — 6 AWG Cu/Al
5	750 kcmil — 2 AWG; or (2) 250 kcmil — 3/0 AWG Cu/Al
6	(2) 750 kcmil — 3/0 AWG Cu/Al
7	(3) 750 kcmil — 3/0 AWG Cu/Al
8	(4) 750 kcmil — 1/0 AWG Cu/Al

Control Terminals — Cu Only	
12 – 16 AWG stranded, 12 – 14 AWG solid	

- ③ Minimum per NEC. Maximum wire size: Sizes 00 and 0 to 8 AWG and Sizes 1 – 2 to 2 AWG.

Wiring Diagrams

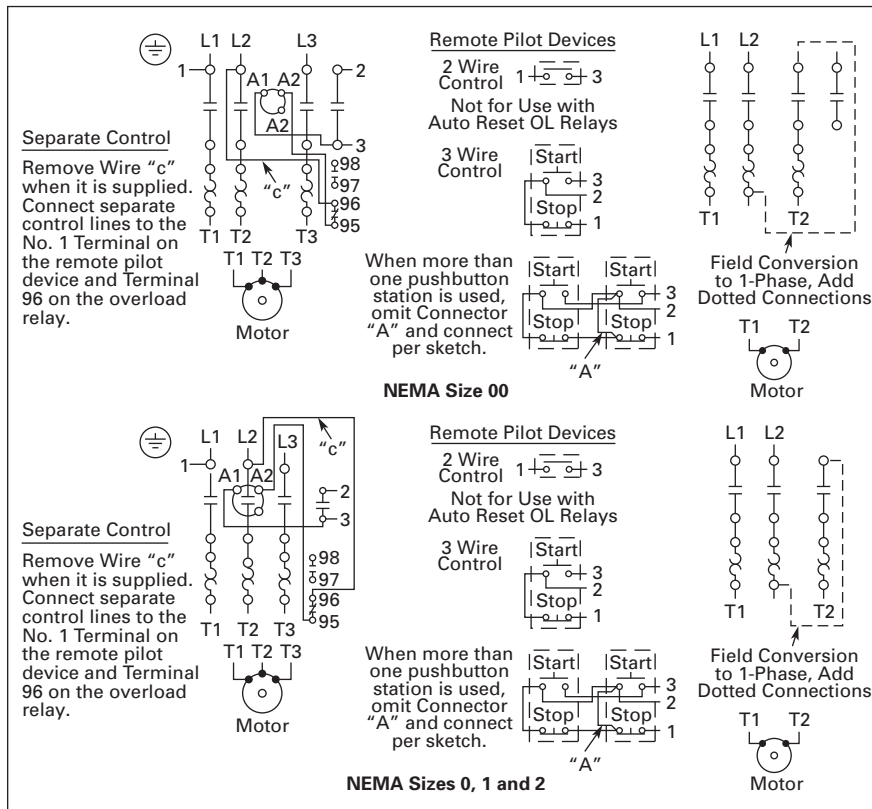

Figure 33-24. Typical Wiring Diagrams — Three-Phase and Single-Phase Applications

Table 33-100. Plugging and Jogging Service Horsepower Ratings ^④

NEMA Size	200V	230V	460V	575V
00	—	1/2	1/2	1/2
0	1-1/2	1-1/2	2	2
1	3	3	5	5
2	7-1/2	10	15	15
3	15	20	30	30
4	25	30	60	60
5	60	75	150	150
6	125	150	300	300

- ④ Maximum horsepower where operation is interrupted more than 5 times per minute, or more than 10 times in a 10 minute period. NEMA Standard ICS2-1993 table 2-4-3.

Kits and Accessories

- Auxiliary Contacts, contactor mounted — **Pages 33-96 – 33-97.**
- Transient Suppressor, for magnet coil — **Pages 33-94.**
- Timers — Solid-State and Pneumatic, mount on contactor — **Page 33-93.**

Renewal Parts Publication Numbers

- See **Page 33-101.**

Product Selection

When Ordering Supply

- Catalog Number
- Heater pack number (see selection table, **Pages 33-117 – 33-118**) or full load current.



*Size 0
Non-reversing
Starter*

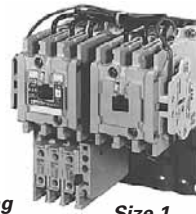

*Size 1
Reversing
Starter*



*Size 3
Vertical
Reversing
Starter*

Table 33-101. Type AN16/AN56 NEMA — Manual or Automatic Reset Overload Relay — Non-reversing and Reversing

NEMA Size	Continuous Ampere Rating	Service-Limit Current Rating ^③ (Amperes)	Maximum UL Horsepower ^②						3-Pole Non-reversing ^①		3-Pole Reversing ^①	Vertical Reversing ^①	Price U.S. \$
			1-Phase		3-Phase				Catalog Number	Price U.S. \$	Catalog Number	Catalog Number	
			115V	230V	208V	240V	480V	600V					
00	9	11	1/3	1	1-1/2	1-1/2	2	2	AN16AN0_C		AN56AN0_C	—	
0	18	21	1	2	3	3	5	5	AN16BN0_C		AN56BN0_C	AN56BNV0_	
1	27	32	2	3	7-1/2	7-1/2	10	10	AN16DN0_B		AN56DN0_B	AN56DNV0_	
2	45	52	3	7-1/2	10	15	25	25	AN16GN0_B		AN56GN0_B	AN56GNV0_	
3	90	104	—	—	25	30	50	50	AN16KN0_		AN56KN0_	AN56KNV0_	
4	135	156	—	—	40	50	100	100	AN16NN0_		AN56NN0_	AN56NNV0_	
5	270	311	—	—	75	100	200	200	AN16SN0_B		AN56SN0_B	—	
6	540	621	—	—	150	200	400	400	AN16TN0_C		AN56TN0_C	—	
7	810	932	—	—	200	300	600	600	AN16UN0_B		AN56UN0_B	—	
8 ^④	1215	1400	—	—	400	450	900	900	AN16VN0_B		AN56VN0_B	—	

Note: Starter Catalog Numbers do not include heater packs. Select one carton of three heater packs. Heater pack selection, **Pages 33-117 – 33-118**.

① Underscore (_) indicates coil suffix required, see **Table 33-102**.

② Maximum horsepower rating of starters for 380V 50 Hz applications:

NEMA Size	00	0	1	2	3	4	5	6	7	8
Horsepower	1-1/2	5	10	25	50	75	150	300	600	900

③ The service-limit current ratings represent the maximum rms current, in amperes, which the controller shall be permitted to carry for protracted periods in normal service. At service-limit current ratings, temperature rises shall be permitted to exceed those obtained by testing the controller at its continuous current rating. The current rating of overload relays or trip current of other motor protective devices used shall not exceed the service-limit current rating of the controller.

④ Common control. For separate 120V control, insert letter **D** in 7th position of listed Catalog Number. EXAMPLE: AN56VND0CB.

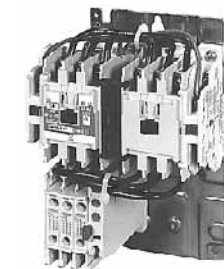

**NEMA Size 0
Cat. No. AN56BN0AC**

Magnet Coils — AC or DC

Starter coils listed in this section also have a 50 Hz rating as shown in the adjacent table. Select required starter by Catalog Number and replace the magnet coil alpha designation in the Catalog Number () with the proper Code Suffix from the adjacent table.

For Sizes 00 – 2 and 5 – 8, the magnet coil alpha designation will be the next to last digit of the listed Catalog Number. EXAMPLE: For a 380V, 50 Hz coil, change AN16BN0_C to AN16BN0LC. For all other sizes, the magnet coil alpha designation will be the last digit of the listed Catalog Number.

For **DC Magnet Coils**, see Accessories, **Pages 33-98 – 33-99**.

Table 33-102. AC Suffix Code

Coil Volts and Hertz	Code Suffix
120/60 or 110/50	A
240/60 or 220/50	B
480/60 or 440/50	C
600/60 or 550/50	D
208/60	E
277/60	H
208 – 240/60 ^⑤	J
240/50	K
380 – 415/50	L
550/50	N
24/60, 24/50 ^⑥	T
24/50	U
32/50	V
48/60	W
48/50	Y

⑤ NEMA Sizes 00 and 0 only.

⑥ NEMA Sizes 00 and 0 only. Sizes 1 – 8 are 24/60 only.

Technical Data **Pages 33-89 – 33-91**
 Overload Relay **Page 33-113**
 Dimensions **Pages 33-106 – 33-108**
 Special Modifications **Page 33-100**
 Accessories **Pages 33-92 – 33-100**
 Heater Packs **Pages 33-117 – 33-118**
 Discount Symbol **1CD1**

Dimensions

Non-reversing Starters, Bi-Metallic Overload

Table 33-149. Approximate Dimensions and Shipping Weights — Open Type

NEMA Size	Dimensions in Inches (mm)					F	G	Ship. Wt. Lbs. (kg)
	Wide A	High B	Deep C	Mounting				
				D	E			
00 - 0	1.80 (45.7)	6.60 (167.6)	3.52 (89.4)	—	6.07 (154.2)	4.90 (124.5)	.54 (13.7)	2.2 (1.0)
1 - 1P	2.56 (65.0)	7.08 (179.8)	4.44 (112.8)	2.00 (50.8)	6.63 (168.4)	5.80 (147.3)	.54 (13.7)	4.5 (2.0)
2	2.56 (65.0)	8.08 (205.2)	4.44 (112.8)	2.00 (50.8)	7.63 (193.8)	5.80 (147.3)	.54 (13.7)	4.7 (2.1)
3	4.08 (103.6)	11.35 (288.3)	5.94 (150.9)	3.00 (76.2)	10.81 (274.6)	—	—	11.0 (5.0)
4	7.05 (179.1)	12.06 (306.3)	7.25 (184.2)	6.00 (152.4)	8.50 (215.9)	—	—	23.0 (10.4)
5	7.00 (177.8)	17.77 (451.4)	7.76 (197.1)	6.00 (152.4)	16.00 (406.4)	—	—	36.0 (16.3)
6	9.47 (240.5)	21.69 (550.9)	9.90 (251.5)	3.10 (78.7)	18.00 (457.2)	—	—	75.0 (34.1)
7	15.13 (384.3)	29.13 (739.9)	12.64 (321.1)	13.25 (336.6)	21.25 (539.8)	—	—	120.0 (54.5)
8	15.13 (384.3)	34.50 (876.3)	15.00 (381.0)	13.25 (336.6)	16.75 (425.5)	—	—	210.0 (95.3)

33

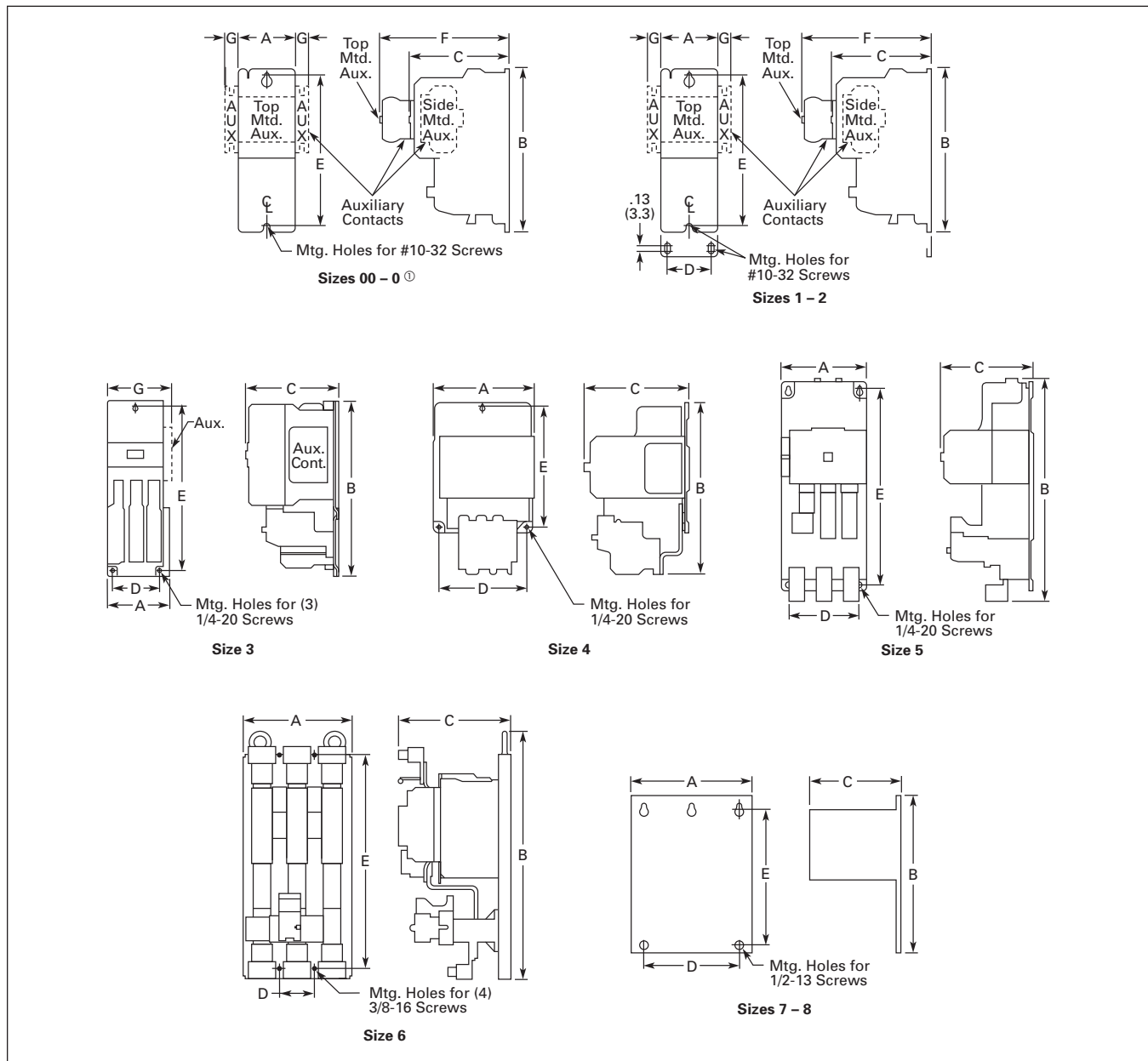

Figure 33-36. Approximate Dimensions

Ⓢ Holding circuit contact for Size 00 occupies 4th power pole position — no increase in width.

Reversing Starters, Bi-Metallic Overload

Table 33-150. Approximate Dimensions and Shipping Weights — Open Type

NEMA Size	Dimensions in Inches (mm)					D1	E1	F	G	Ship. Wt. Lbs. (kg)
	Wide A	High B	Deep C	Mounting						
				D	E					
00 - 0	4.20 (106.7)	7.38 (187.5)	3.52 (89.4)	3.50 (88.9)	6.87 (174.5)	—	—	4.90 (124.5)	.54 (13.7)	3.6 (1.6)
1	5.71 (145.0)	7.08 (179.8)	4.44 (112.8)	5.25 (133.4)	5.75 (146.1)	—	—	5.80 (147.3)	.54 (13.7)	8.3 (3.8)
2	5.71 (145.0)	8.08 (205.2)	4.44 (112.8)	5.25 (133.4)	6.75 (171.5)	—	—	5.80 (147.3)	.54 (13.7)	8.5 (3.9)
3	8.70 (221.0)	11.35 (288.3)	5.94 (150.9)	7.00 (177.8)	10.81 (274.6)	—	—	—	—	20.0 (9.1)
4	14.68 (372.9)	12.06 (306.3)	7.25 (184.2)	13.50 (342.9)	8.50 (215.9)	—	—	—	—	49.0 (22.2)
5	14.50 (368.3)	17.77 (451.4)	7.76 (197.1)	13.50 (342.9)	16.00 (406.4)	—	—	—	—	68.0 (30.9)
6	19.77 (502.2)	22.63 (574.8)	9.90 (251.5)	18.00 (457.2)	12.00 (304.8)	3.10 (78.7)	18.00 (457.2)	—	—	90.0 (40.9)
7	28.06 (712.7)	32.13 (816.1) ①	12.70 (322.6)	12.75 (323.9)	21.25 (539.8)	—	—	—	—	175.0 (79.5)
8	30.38 (771.7)	41.50 (1054.1) ①	14.70 (373.4)	14.13 (358.9)	16.75 (425.5)	—	—	—	—	430.0 (195.2)

① Includes cross wiring overhang.

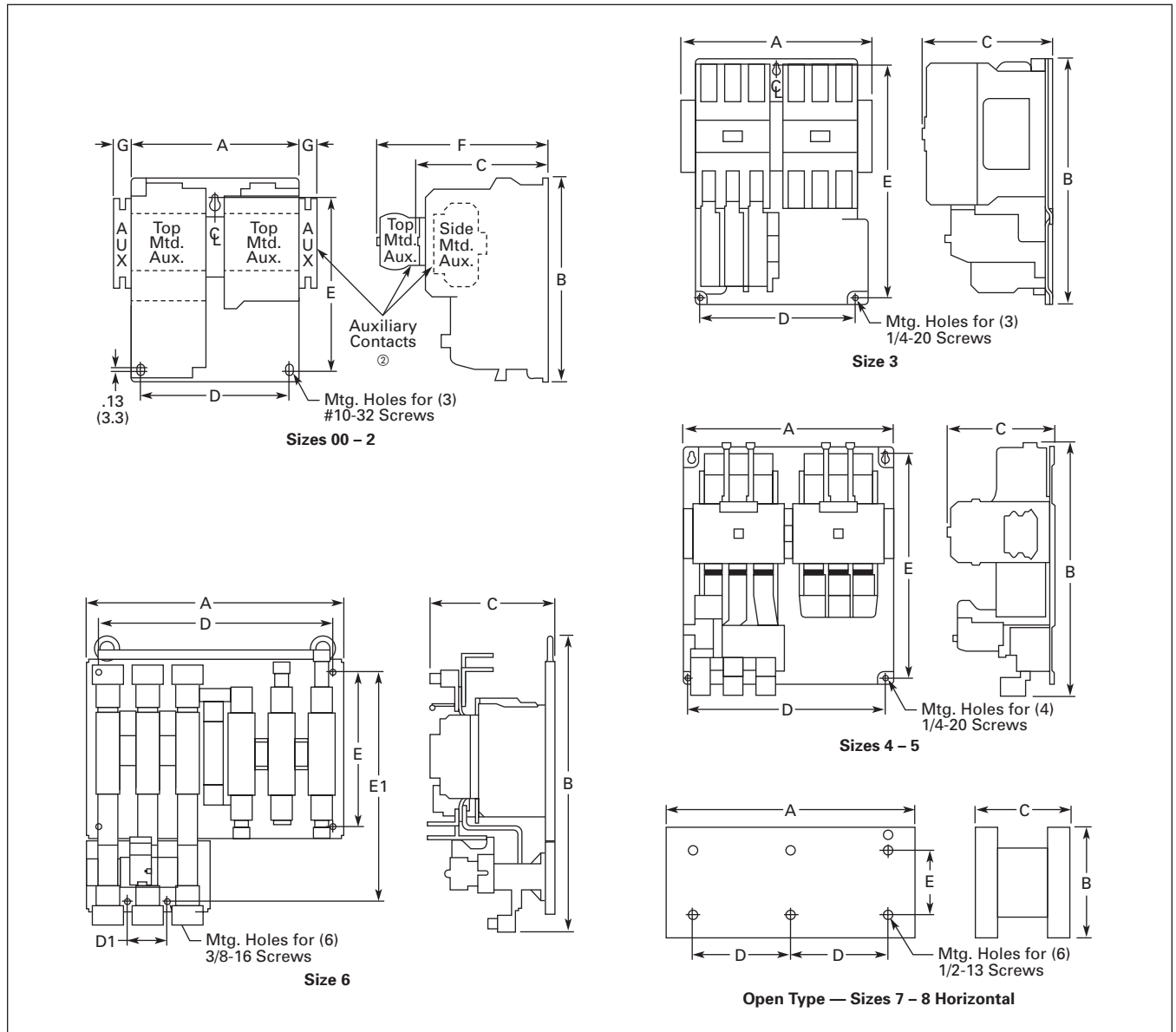

Figure 33-37. Approximate Dimensions

② See catalog listings for type and location of auxiliary contacts supplied with a particular starter.