

Bring Wire & Cable Down to Business

Routing power, data, and A/V – neatly and simply – from up there to down here; that’s what Tele-Power® Poles are all about. Their sole purpose is to get the business end of your wire and cabling needs down to your workstation, equipment, or modular furniture. Specifically, in away-from-the-wall locations in open commercial office areas, schools, labs, stores, nurses stations, and other sites.

Whatever power, data, or A/V wiring you need to bring down to the desk, workstation, or cash registers, Wiremold Tele-Power Poles handle all of your needs effortlessly. For modular office furniture – our poles easily provide the hook up to feed office partitions. The poles are also available with specialized electrical circuits such as dedicated/isolated ground. Vertical drop poles give you the flexibility and capacity to devote both sides of the pole for single or dual service feeds. Legrand/Wiremold offers the broadest selection of open space solutions. With standard, custom and configurable products, you can rest assured that the right solution is readily available and adaptable to your current and future work environments.



The right vertical solution for any situation.

FEATURES & BENEFITS

- **Promote sustainable design.** Allowing services to be routed to the center of an open space rather than by building a wall increases the use of natural daylight and reduces energy consumption.
- **Bring power, data, and A/V services into open space environments quickly & easily.** Easy to install. Reduces costs for moves, adds and changes.
- **Wide selection of standard options.** Stocked in a variety of materials, finishes, sizes, and device configurations. Provides what you want, when you need it.
- **Relocatable.** Ready for service in 30 minutes or less. Can be quickly reconfigured or relocated as work space uses and service needs change.
- **Dual-channel.** Allows a single drop point for access to multiple services.
- **Accessory packs included.** Furnished with feed fittings, ceiling trim plates, T-Bar mounting hardware, and carpet/floor grippers. Everything you need for a complete and stationary installation accommodating a variety of installation scenarios.
- **Custom capabilities.** Modify receptacle type and location, change color finish, alter pole heights, add fixture whips and more. Affording you more choice in appearance and configuration.
- **On-site configurability.** In-field modifications, including adding devices and changing the height, make Tele-Power poles even more flexible.
- **A/V Compatibility.** 30TP Series are now compatible with A/V devices to allow for a full range of services to your work stations.
- **Datacom connectivity options.** Accepts industry standard and proprietary devices from a wide range of manufacturers to provide a seamless and aesthetically pleasing interface for voice, data, audio, and video applications at the point of use.
- **New TPP-E Series Tele-Power Pole Extenders combine quick installation with easy job-site handling.** Snap together 5' sections to create a pole or extend the length of your existing 25TP series pole. These new extenders accommodate a variety of ceiling heights, can ship UPS or air freight for quick & reliable delivery.



New Tele-Power Pole Extenders make transporting and installing power poles a snap, literally.

Field Modifications for Tele-Power Poles

MODIFICATION	TELE-POWER POLE SERIES									
	30TP-4V	30TC-4V	30TP-2V	30TC-2V	25DTP-4	25DTP-4D	25DTC-4	AMDTP-4	AMDTP-4D	AMTC-4
Can the receptacles in the standard pole be rewired in order to have a two circuit pole with standard duplexes?	Yes	N/A	Yes	N/A	No	Yes	N/A	No	Yes	N/A
Can the receptacles in the standard pole be replaced with other types? (i.e. Hospital Grade, TVSS, GFCI, etc.)	Yes – Using the proper device cover	N/A	Yes – Using the proper device cover	N/A	Yes – with 2507C Bracket & only with NEMA duplex receptacles	Yes – only with NEMA duplex receptacles	N/A	Yes – with 2507C Bracket & only with NEMA duplex receptacles	Yes – only with NEMA duplex receptacles	N/A
Can receptacles be added to blank poles?	N/A	Yes	N/A	Yes – Using the proper device cover	N/A	N/A	Yes	N/A	N/A	Yes
Can blank poles be used for furniture feed applications by field punching KOs on poles for power and voltage?	N/A	Yes	N/A	Yes	N/A	N/A	Yes	N/A	N/A	Yes
Can more than one add-on device cover be used?	N/A	N/A	N/A	N/A	Yes	Yes	N/A	Yes	Yes	N/A
Can receptacles be installed in both sides of the pole?	Yes – Power only on both sides	Yes – Power only on both sides	N/A	N/A	No	No	N/A	No	No	N/A
Can poles be field cut for use in lower ceiling applications?	Yes*	Yes*	Yes*	Yes*	Yes*	Yes*	Yes*	Yes*	Yes*	Yes*
Can poles be mounted to hard or open ceilings?	Yes**	Yes**	Yes**	Yes**	Yes**	Yes**	Yes**	Yes**	Yes**	Yes**

* Review instruction sheet for instructions for cutting poles.

** Pole housing cannot be penetrated. Ceiling mounting hardware must provide firm support and must be supplied by installer.

NOTE: All receptacles, additions, rewiring and other electrical modifications must be made by a qualified electrician in accordance with the NEC or other applicable local codes and adhering to the wire fill capacity charts for the respective pole.



Specially-designed Tele-Power Poles can be fitted with lighted signage while also bringing power and data to cash wraps and counter areas, or used to feed services to display cases, photo kiosks and price check stations.

Steel Tele-Power Poles

Steel Tele-Power Poles are the workhorse of vertical wire and cable management solutions. They are available either prewired with electrical devices or as blanks to feed services to other wire and cable management systems, such as electrified modular furniture. As the long time industry standard, steel Tele-Power Poles are available with an ivory enamel finish and are available in a variety of lengths. They also offer the flexibility of field configuration or can be customized to customer specifications.

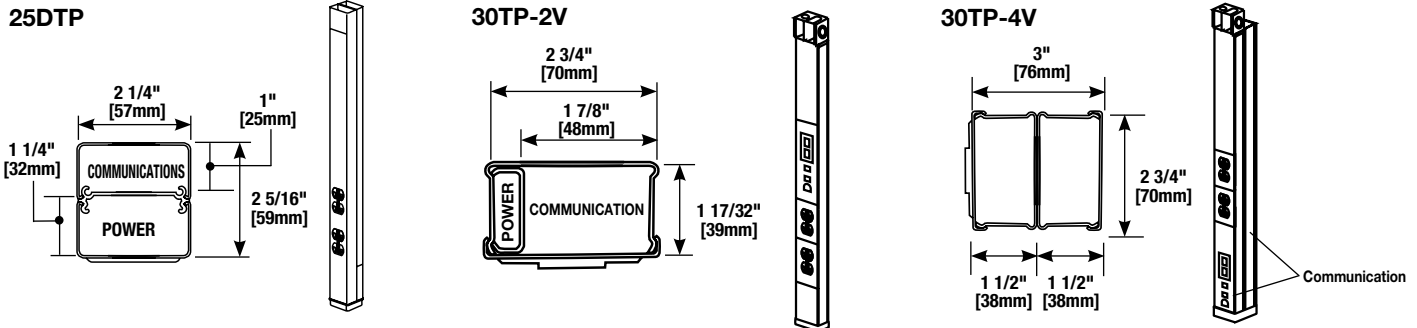

NOTE: Custom colors, other lengths (20' [6.1m] max.) or additional circuits are available on custom orders. Consult factory for more information. Can be factory or field wired with many commercially available devices.

25DTP & 30TP Series Tele-Power Poles Wire Fill Capacities

CATALOG NUMBER	NUMBER & TYPE OF POWER OUTLETS	POLE HEIGHT Inches [mm]	FINISH	Wire Size		Cat 5		Cat 6		RG58/U		RG62A/U		RG6/U	
				#10	#12	0.22" [5.6mm]	0.25" [6.3mm]	0.25" [6.3mm]	0.195" [5.0mm]	0.242" [6.1mm]	0.270" [6.9mm]	20%*	40%**	20%*	40%**
25DTP-4	Two Duplex Receptacles (20A, 125V)	10' 5" [3.175m]	Ivory/Gray	10	15	10	19	9	17	13	25	8	16	7	13
25DTP-412		12' 5" [3.780m]	Ivory/Gray	10	15	10	19	9	17	13	25	8	16	7	13
25DTP-415		15' 5" [4.700m]	Ivory/Gray	10	15	10	19	9	17	13	25	8	16	7	13
25DTP-E10		10' 5" [3.175m]	Ivory/Gray	10	15	10	19	9	17	13	25	8	16	7	13
25DTP-4D	Two Duplex Receptacles (20A, 125V), One Dedicated/Isolated & One Standard Branch Circuit	10' 5" [3.175m]	Ivory/Gray	10	15	10	19	9	17	13	25	8	16	7	13
25DTP-4ACT	Two Duplex Receptacles (20A, 125V), One Communications Insert Mounting Adapter, Three Blank Inserts	10' 5" [3.175m]	Ivory/Gray	10	15	10	19	9	17	13	25	8	16	7	13
30TP-2V	Two Duplex Receptacles (20A, 125V)	10' 5" [3.175m]	Ivory	9	14	61	31	13	26	20	40	13	25	10	20
30TP-212V		12' 5" [3.780m]	Ivory	9	14	61	31	13	26	20	40	13	25	10	20
30TP-215V		15' 5" [4.700m]	Ivory	9	14	61	31	13	26	20	40	13	25	10	20
30TP-4V	Two Duplex Receptacles (20A, 125V)	10' 5" [3.175m]	Ivory	18	18	19	37	15	30	24	47	15	30	12	24
30TP-412V		12' 5" [3.780m]	Ivory	18	18	19	37	15	30	24	47	15	30	12	24
30TP-4V3S2		10' 5" [3.175m]	Ivory	18	18	19	37	15	30	24	47	15	30	12	24
30TP-412V3S2		12' 5" [3.780m]	Ivory	18	18	19	37	15	30	24	47	15	30	12	24

* 20% cable fill is calculated to approximate reduction in cable capacity due to connectors mounted within pole section that may restrict cross-sectional areas.

** 40% cable fill is the maximum designed cable fill based on a proposed revision to TIA/EIA 569-A.

25DTC & 30TC Series Vertical Drop Poles Communications Fill Capacities

CATALOG NUMBER	POLE HEIGHT Inches [mm]	FINISH	Cat 5		Cat 6		RG58/U		RG62A/U		RG6/U	
			Sm. Comp.	Lg. Comp.	Sm. Comp.	Lg. Comp.	Sm. Comp.	Lg. Comp.	Sm. Comp.	Lg. Comp.	Sm. Comp.	Lg. Comp.
25DTC-4	10' 5" [3.175m]	Ivory/Gray	19	26	16	22	25	33	16	21	12	17
25DTC-412	12' 5" [3.780m]	Ivory/Gray	19	26	16	22	25	33	16	21	12	17
25DTC-415	15' 5" [4.700m]	Ivory/Gray	19	26	16	22	25	33	16	21	12	17
25DTC-E10	10' 5" [3.175m]	Ivory/Gray	19	26	16	22	25	33	16	21	12	17
30TC-2V	10' 5" [3.175m]	Ivory	n/a	33	n/a	30	n/a	47	n/a	30	n/a	24
30TC-212V	12' 5" [3.780m]	Ivory	n/a	33	n/a	30	n/a	47	n/a	30	n/a	24
30TC-215V	15' 5" [4.700m]	Ivory	n/a	33	n/a	30	n/a	47	n/a	30	n/a	24
30TC-4V	10' 5" [3.175m]	Ivory	37	37	30	30	47	47	30	30	24	24
30TC-412V	12' 5" [3.780m]	Ivory	37	37	30	30	47	47	30	30	24	24
30TC-415V	15' 5" [4.700m]	Ivory	37	37	30	30	47	47	30	30	24	24
30TC-3S2	10' 5" [3.175m]	Ivory	37	37	30	30	47	47	30	30	24	24
30TP-412V3S2	12' 5" [3.780m]	Ivory	37	37	30	30	47	47	30	30	24	24

Steel Tele-Power Poles Ordering Information

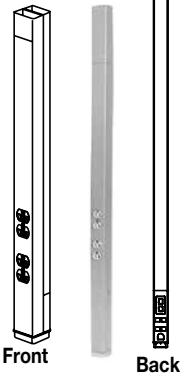
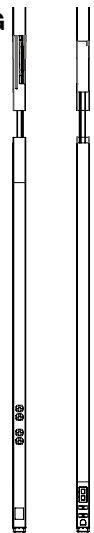
Catalog No./Item	Description/Specifications
<p>25DTP-4 25DTP-4-DG 25DTP-412 25DTP-412-DG 25DTP-415 25DTP-415-DG</p>  <p>Front Back</p>	<p>Tele-Power Pole – Two-compartment pole (power and communications). Nominal material thickness .030" [0.8mm]. Ivory or gray bootbase. Factory wired with fed-spec general grade 20A/125V duplex style receptacles. An 8" [203mm] cover at top front of pole is removable for making power wiring connections. KOs provided in removable cover for RJ11/RJ45 and modular furniture communication connectors. Mounting hardware, entrance end plate and two ceiling trim plates furnished. Available in standard lengths of 10' 5" [3.2m] (25DTP-4), 12' 5" [3.8m] (25DTP-412) and 15' 5" [4.7m] (25DTP-415). Also increase the length of any 25 Series pole with the 25DTC-E5 Tele-Power Pole Extender.</p>
<p>25DTP-4ACT 25DTP-4ACT-DG</p>	<p>Tele-Power Pole – Identical to 25DTP-4 except with one communications insert mounting adapter and three (3) blank inserts.</p>
<p>25DTP-4D 25DTP-4D-DG</p>	<p>Tele-Power Pole – Identical to 25DTP-4 except has one 20A 125V dedicated/isolated ground duplex receptacle and one 20A 125V standard duplex receptacle.</p>
<p>25DTP-E10 25DTP-E10-DG</p>  <p>Front Back</p>	<p>Tele-Power Pole Extender – Two sections of a two-compartment pole (power and communication) pole (5' 4" [1.626m] base + 5' [1.524m] extender) assembles to form a 10' 4" [3.148m] pole. Nominal material thickness .040" [1.0mm]. Ivory or gray boot base. Factory wired with fed-spec general grade 20A 125V duplex style receptacles. An 8" [203mm] cover at top front (power side) of pole is removable for making power wiring connections. KOs provided in removable cover for RJ11/RJ45 and modular furniture communication connectors. Mounting hardware, entrance end plate and two ceiling trim plates furnished.</p>



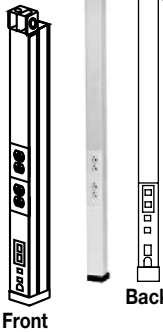
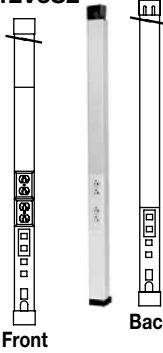

NOTE: Custom colors, custom lengths (20' [6.1m] max.) or additional circuits are available on custom order. Consult factory for more information. Can be factory or field-wired with many commercially available devices.

Catalog No./Item	Description/Specifications
<p>30TP-2V 30TP-212V</p>  <p>Front Back</p>	<p>Tele-Power Pole – Two-compartment pole (power and communications). Nominal material thickness .040" [1.0mm]. Factory wired with two specification grade 20A, 125V duplex receptacles. Mounting hardware, entrance end fitting, and ceiling trim plate furnished. Available in standard lengths of 10' 5" [3.2m] (30TP-2V) and 12' 5" [3.8m] (30TP-212V).</p>
<p>30TP-4V 30TP-412V</p>  <p>Front Back</p>	<p>Tele-Power Pole – Two-compartment pole (one power; one communication with crossover below power devices). Nominal material thickness .040" [1.0mm]. Factory wired with two specification grade 20A, 125V duplex receptacles. Mounting hardware, entrance end fitting, and ceiling trim plate furnished. Available in standard lengths of 10' 5" [3.2m] (30TP-4V) and 12' 5" [3.8m] (30TP-412V).</p>
<p>30TP-4V3S2 30TP-412V3S2</p>  <p>Front Back</p>	<p>Tele-Power Pole – Two duplex receptacles (20A, 125V). One Ortronics® Series II adapter. One Ortronics® Series II dual Cat. 5e insert, two blank inserts and labeling supplies. Available in standard lengths of 10' 5" [3.2m] (30TP-4V3S2) and 12' 5" [3.8m] (30TP-412V3S2).</p>

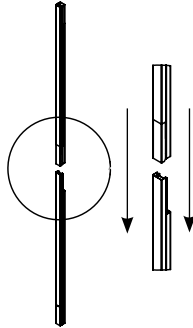

Wiremold Tele-Power Poles offer relocation flexibility to support open office designs. Quickly and easily reconfigure poles to meet changes in floor plans or capacity needs.

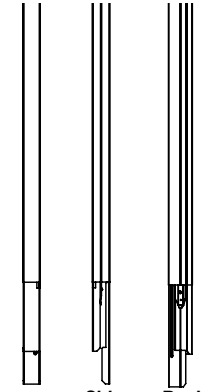
Steel Vertical Drop Poles Ordering Information

Catalog No./Item	Description/Specifications	Catalog No./Item	Description/Specifications
<p>25DTC-4 25DTC-4-DG 25DTC-412 25DTC-412-DG 25DTC-415 25DTC-415-DG</p> 	<p>Blank Steel Pole – Two-compartment pole. Nominal material thickness .040" [1.0mm]. Ivory or gray boot base. Furnished unwired without outlets. Mounting hardware, entrance end plate and ceiling trim plates furnished. Available lengths: 10' 5" [3.2m] (25DTC-4), 12' 5" [3.8m] (25DTC-412) and 15' 5" [4.7m] (25DTC-415).</p>	<p>25DTC-E10 25DTC-E10-DG</p> 	<p>Blank Steel Tele-Power Pole Extender – Two sections of a two-compartment pole (5' 4" [1.626m] base and 5' [1.52m] extender) assemblies to form a 10' 4" [3.148m] pole. Nominal material thickness .040" [1.0mm]. Ivory or gray boot base. Furnished unwired without outlets. Mounting hardware, entrance end plate and ceiling trim plate furnished. An 8" [203mm] cover at top of pole is removable for making power wiring connections.</p>
<p>30TC-2V 30TC-212V 30TC-215V</p> 	<p>Blank Steel Pole – Single-compartment pole. Furnished unwired without outlets. Nominal wall thickness .040" [1.0mm]. Mounting hardware, entrance end fitting, and ceiling trim plate furnished. Available lengths: 10' 5" [3.2m] (30TC-2V), 12' 5" [3.8m] (30TC-212V) and 15' 5" [4.7m] (30TC-215V).</p>	<p>25DTC-E5 25DTC-E5-DG</p> 	<p>Blank Steel Tele-Power Pole Extender – Two-compartment extender mounts onto existing 25DTP or 25DTC series pole. Nominal material thickness .040" [1.0mm]. Furnished unwired without outlets. Use existing pole mounting hardware, entrance end plate and ceiling trim plate. Available in 5' [1.524m] length. Can be cut to desired length.</p>
<p>30TC-4V 30TC-412V 30TC-415V</p> 	<p>Blank Steel Pole – Two-compartment pole. Furnished unwired without outlets. Nominal wall thickness .040" [1.0mm]. Mounting hardware, entrance end fitting, and ceiling trim plate furnished. Available lengths: 10' 5" [3.2m] (30TC-4V), 12' 5" [3.8m] (30TC-412V) and 15' 5" [4.7m] (30TC-415V).</p>		

NOTE: All poles have removable cover sections with KOs for modular jacks and openings to accept modular furniture adapters for communication devices.







Wiremold Tele-Power Poles offer a wide variety of custom and service configuration options to accommodate most installation requirements.



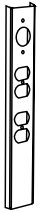

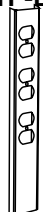
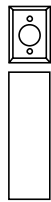
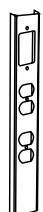
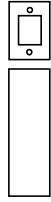

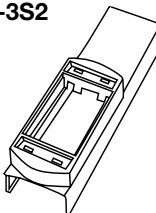
Steel Tele-Power Poles (continued)

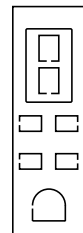
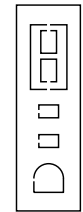
A full range of accessories enables fast and easy field configurability. Additional receptacles or devices can be added to existing poles for maximum flexibility. While the new Tele-Power Pole Extender allows for easy, on-site modifications to accommodate a variety of height requirements.

Accessories for Steel Tele-Power Poles Ordering Information

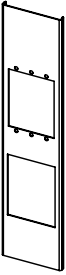
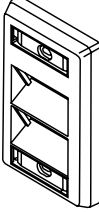
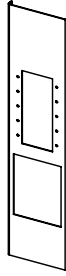
Catalog No./Item	Description/Specifications	Catalog No./Item	Description/Specifications									
AMDTP-A 25DTP-A 	Add-On Power Cover – Add power receptacles or devices to existing modular Tele-Power Poles. Includes receptacle mounting bracket. Face diameter of single receptacle: 1.38" -1.40" [35mm - 36mm].	30TP-C 	Single Gang Cover – Accepts up to 30A shallow-style device and flushplate. G3007 Device Bracket included. Ivory finish. Used to mount industry standard straight and angled communication faceplates.									
	<table border="1" style="margin-left: auto; margin-right: auto;"> <thead> <tr> <th style="width: 15%;"></th> <th style="width: 25%;">COLOR</th> <th style="width: 60%;">DIMENSIONS</th> </tr> </thead> <tbody> <tr> <td>25DTP-A</td> <td>Ivory Steel (25DTP-4)</td> <td>1" x 2 1/4" x 28"</td> </tr> <tr> <td>AMDTP-A</td> <td>Anodized Aluminum (AMDTP-4)</td> <td>[25mm x 57mm x 711mm]</td> </tr> </tbody> </table>		COLOR	DIMENSIONS	25DTP-A	Ivory Steel (25DTP-4)	1" x 2 1/4" x 28"	AMDTP-A	Anodized Aluminum (AMDTP-4)	[25mm x 57mm x 711mm]		
	COLOR	DIMENSIONS										
25DTP-A	Ivory Steel (25DTP-4)	1" x 2 1/4" x 28"										
AMDTP-A	Anodized Aluminum (AMDTP-4)	[25mm x 57mm x 711mm]										
AMDTP-B 25DTP-B 	Add-On Power Cover – Add power receptacles or devices to existing modular Tele-Power Poles. Includes receptacle mounting bracket.	30TP-J 	Single Receptacle Cover – For field installation of single receptacles with face diameters of 1.56" [40mm] diameter. G3007 Device Bracket included. Ivory finish.									
	<table border="1" style="margin-left: auto; margin-right: auto;"> <thead> <tr> <th style="width: 15%;"></th> <th style="width: 25%;">COLOR</th> <th style="width: 60%;">DIMENSIONS</th> </tr> </thead> <tbody> <tr> <td>25DTP-B</td> <td>Ivory Steel (25DTP-4)</td> <td>1" x 2 1/4" x 28"</td> </tr> <tr> <td>AMDTP-B</td> <td>Anodized Aluminum (AMDTP-4)</td> <td>[25mm x 57mm x 711mm]</td> </tr> </tbody> </table>		COLOR	DIMENSIONS	25DTP-B	Ivory Steel (25DTP-4)	1" x 2 1/4" x 28"	AMDTP-B	Anodized Aluminum (AMDTP-4)	[25mm x 57mm x 711mm]		
	COLOR	DIMENSIONS										
25DTP-B	Ivory Steel (25DTP-4)	1" x 2 1/4" x 28"										
AMDTP-B	Anodized Aluminum (AMDTP-4)	[25mm x 57mm x 711mm]										
AMDTP-L 25DTP-L 	Add-On Power Cover – Add power receptacles or devices to existing modular Tele-Power Poles. Includes receptacle mounting bracket.	30TP-L 	Rectangular Device Cover – Rectangular faceplate to accommodate Sentrex surge receptacles, GFCI and other decorator style devices. G3007 Device Bracket included. Ivory finish.									
	<table border="1" style="margin-left: auto; margin-right: auto;"> <thead> <tr> <th style="width: 15%;"></th> <th style="width: 25%;">COLOR</th> <th style="width: 60%;">DIMENSIONS</th> </tr> </thead> <tbody> <tr> <td>25DTP-L</td> <td>Ivory Steel (25DTP-4)</td> <td>1" x 2 1/4" x 28"</td> </tr> <tr> <td>AMDTP-L</td> <td>Anodized Aluminum (AMDTP-4)</td> <td>[25mm x 57mm x 711mm]</td> </tr> </tbody> </table>		COLOR	DIMENSIONS	25DTP-L	Ivory Steel (25DTP-4)	1" x 2 1/4" x 28"	AMDTP-L	Anodized Aluminum (AMDTP-4)	[25mm x 57mm x 711mm]		
	COLOR	DIMENSIONS										
25DTP-L	Ivory Steel (25DTP-4)	1" x 2 1/4" x 28"										
AMDTP-L	Anodized Aluminum (AMDTP-4)	[25mm x 57mm x 711mm]										
30TP-A 	Single Receptacle Cover – Single receptacle cover for field installation of receptacles with face diameters of 1.38" - 1.40" [25mm - 36mm]. G3007C Device Bracket included. Ivory finish.	25DTC-3S2 	Data & A/V Add-On Cover for 25DTP Series Poles – Accepts Ortronics® Series II Modular Connectivity Solutions.									
30TP-B 	Duplex Receptacle Cover – For installations of 15A and 20A duplex receptacles. G3007C Device Bracket included. Ivory finish.	25DTC-CVR 	Data & A/V Add-On Cover for 25DTP Series Poles – Accepts discrete jacks.									
		30TC-CVR 	Data & A/V Add-On Cover for 30TC Series Poles – Accepts discrete jacks.									

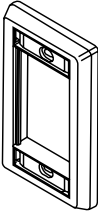
Accessories for Steel Tele-Power Poles Ordering Information (continued)

Catalog No./Item	Description/Specifications	Catalog No./Item	Description/Specifications
30TP-AAP	 <p>Add-On A/V Cover – Accepts three (3) Extron® Electronics AAP plates 12" L x 2.75" W [305mm x 70mm]. Includes three adapters to accommodate Ortronics® or Wiremold Open System devices.</p>	CM-SAP	 <p>Data & A/V Add-On Cover for 30TC Series Poles – Single-gang, angled faceplate accepts CM Series Connectors. (Requires 30TP-C Mounting Plate.)</p>
30TP-MAAP	 <p>Add-On A/V Cover – Accepts five (5) Extron® Electronics MAAP plates 12" L x 2.75" W [305mm x 70mm]. Includes three adapters to accommodate Ortronics® or Wiremold Open System devices.</p>	25AM10FO	 <p>Data & A/V Add-On Cover for 25DTP Series Poles – 2" [51mm] radius control Entrance End Fitting.</p>
CM-SFP	 <p>Data & A/V Add-On Cover for 30TC Series Poles – Single-gang faceplate accepts CM Series Connectors. (Requires 30TP-C Mounting Plate.)</p>	25AM-AP 30TP-AP	<p>Replacement Accessory Pack – For 25DTP and 25DTC Series Poles (25AM-AP) or 30TP-2 and 30TP-4 Series Poles (30TP-AP). Includes: gripper pad, ceiling trim plate, bracket and grommet.</p>
25DTC-ACT	 <p>25DTP Kit with 8" [203mm] hole cut cover and mounting adapter</p>		

Aluminum Tele-Power Poles

When looking to dress up a vertical solution, Tele-Power Poles with a satin anodized aluminum finish in either rectangular or round styles can provide the answer. Light weight aluminum construction makes these poles easy to install and maneuver on the job site. Available prewired with electrical devices or blank to drop services feeding another wire and cable management system, such as electrified modular furniture. A full range of accessories enables field configurability, or have them delivered to your specifications.

AMDTP-4

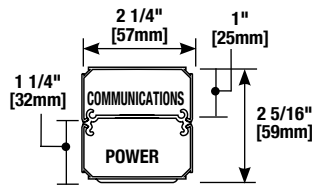

ALTP

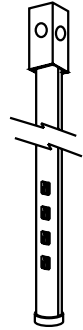
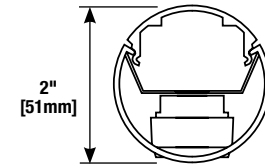

NOTE: There is no method provided for mounting data in this pole.

NOTE: Custom colors, other lengths (20' [6.1m] max.) or additional circuits are available on custom order. Consult factory for more information. Can be factory or field wired with many commercially available devices.

Aluminum Tele-Power Poles Wire Fill Capacities

CATALOG NUMBER	NUMBER & TYPE OF POWER OUTLETS	POLE HEIGHT		FINISH	Wire Size		Cat 5		Cat 6		RG58/U		RG62A/U		RG6/U	
		Inches	[mm]		#10	#12	0.22" [5.6mm]	0.25" [6.3mm]	0.195" [5.0mm]	0.242" [6.1mm]	0.270" [6.9mm]	20%*	40%**	20%*	40%**	20%*
AMDTP-4	Two Duplex Receptacles (20A, 125V)	10' 5"	[3.175m]	Satin Anodized Aluminum	10	15	10	19	8	16	13	25	8	16	7	13
AMDTP-412		12' 5"	[3.780m]		10	15	10	19	8	16	13	25	8	16	7	13
AMDTP-415		15' 5"	[4.700m]		10	15	10	19	8	16	13	25	8	16	7	13
AMDTP-4D	Two Duplex Receptacles (20A, 125V), One Dedicated/Isolated & One Standard Branch Circuit	10' 5"	[3.175m]	Satin Anodized Aluminum	10	15	10	19	8	16	13	25	8	16	7	13
ALTP-2S	Four Single Receptacles	10' 4"	[3.150m]	Satin Anodized Aluminum	-	-	2	5	2	4	3	6	2	4	1	3

* 20% cable fill is calculated to approximate reduction in cable capacity due to connectors mounted within pole section that may restrict cross-sectional areas.

** 40% cable fill is the maximum designed cable fill based on a proposed revision to TIA/EIA 569-A.





Use Wiremold Tele-Power Poles to deliver multiple services to your desired point-of-use or simply as a feeder system for modular furniture.

Aluminum Tele-Power Poles (continued)

Aluminum Vertical Drop Poles Communications Fill Capacities

CATALOG NUMBER	POLE HEIGHT		FINISH	Cat 5		Cat 6		RG58/U		RG62A/U		RG6/U	
	Inches	[mm]		0.22" [5.6mm]	0.25" [6.3mm]	0.195" [5.0mm]	0.242" [6.1mm]	0.270" [6.9mm]	Sm. Comp.	Lg. Comp.	Sm. Comp.	Lg. Comp.	Sm. Comp.
AMDTP-4	10' 5"	[3.175m]	Satin	10	19	8	16	13	25	8	16	7	13
AMDTP-412	12' 5"	[3.780m]	Anodized	10	19	8	16	13	25	8	16	7	13
AMDTP-415	15' 5"	[4.700m]	Aluminum	10	19	8	16	13	25	8	16	7	13
ALTP-2S	10' 4"	[3.150m]	Aluminum	10		8		13		8		6	
NP800C-12-2B NP800C-12-8B NP800C-15-2B	10' 2" 12' 8" 15' 2"	[3.098m] [3.860m] [4.620m]	Aluminum	Please see Chart on the next page for Wire & Cable Capacities of the various configurations of the NP800 Series Poles.									

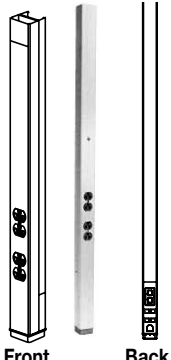
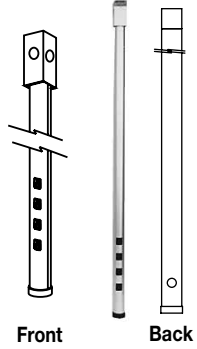
Aluminum Tele-Power Poles Ordering Information



Catalog No./Item	Description/Specifications	Catalog No./Item	Description/Specifications
AMDTP-4 AMDTP-412 AMDTP-415 	<p>Tele-Power Pole – Two-compartment pole (power and communications). Nominal material thickness .050" [1.8mm]. Length: 10' 5" [3.2m]. Factory wired with fed-spec general grade 20A125V duplex style receptacles. An opening for communications and a 1/2" [12.7mm] hole for power is provided at top. The 8" [203mm] cover at the top front of the pole is removable for making power wiring connections. Communication KOs provided for RJ11/RJ45 and modular furniture connectors. Mounting hardware, entrance end plate and two ceiling trim plates furnished. Available in standard lengths of: 10' 5" [3.2m] (25DTP-4), 12' 5" [3.8m] (25DTP-412) and 15' 5" [4.7m] (25DTP-415).</p>	ALTP-2S 	<p>Round Tele-Power Pole – Satin anodized extruded aluminum pole. Nominal wall thickness .060" [1.5mm]. Length 10' 5" [3.2m]. Two-compartment (power and communication channels). Factory wired with four 15A 125V NEMA 5-15R devices. Provided with one 1/2" trade size KO in cover at base for communications. T-Bar mounting hardware, ceiling trim kit, and feed box furnished.</p>
AMDTP-4-C (10' 5" [3.2m] Length) AMDTP-412-C (12' 5" [3.8m] Length) AMDTP-415-C (15' 5" [4.7m] Length) 	<p>Tele-Power Pole – Available in Canada Only. Two-compartment pole (power and communications). Nominal material thickness .050" [1.8mm]. Length: 10' 5" [3.2m]. Factory wired with 15A 125V fed-spec general grade duplex style receptacles. An opening for communication and a 1/2" [12.7mm] hole for power is provided at top. The 8" [203mm] cover at top front of pole is removable for making power wiring connections. Communication KOs provided for RJ11/RJ45 and modular furniture connectors. Mounting hardware, entrance end fitting, and ceiling trim plates furnished. Anodized aluminum finish. Maximum ceiling height 10' [3m]. Comes with a 10' [3.0m] cord.</p>		
AMDTP-4D	<p>Tele-Power Pole – Identical to AMDTP-4 except factory wired with one 20A 125V dedicated/isolated ground duplex receptacle and one 20A 125V standard duplex receptacle.</p>		

NOTE: Custom colors, custom lengths (20' [6.1m] max.) or additional circuits are available on custom order. Consult factory for more information. Can be factory or field wired with many commercially available devices.





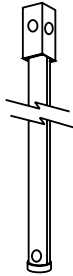



Aluminum Vertical Drop Poles

A full range of accessories enables fast and easy field configurability. Additional receptacles or devices can be added to existing poles for maximum flexibility. The NP800 pole is the epitome of flexibility, featuring a snap-in divider which permits up to six channels of varying sizes and accommodates up to 60A devices (#6 AWG max). The NP800 may be wired with up to 12 receptacles with the number of circuits limited by the feed method.

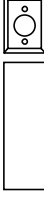

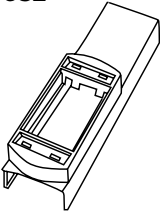
Aluminum Vertical Drop Poles Ordering Information

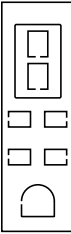
Catalog No./Item	Description/Specifications	Catalog No./Item	Description/Specifications
<p>AMTC-4 AMTC-412 AMTC-415</p> <p>CUSTOM OPTIONS: Features such as colors or other lengths (20' [6.1m] maximum) available on custom orders.</p> 	<p>Blank Aluminum Pole – Two-compartment pole. Nominal material thickness .050" [1.8mm]. Furnished unwired without outlets. Two 8" [203mm] removable covers with KOs for modular jacks and modular furniture communication outlets. Mounting hardware, entrance end plate, and ceiling trim plates furnished.</p> <p>Available lengths: 10' 5" [3.2m] (AMTC-4), 12' 5" [3.8m] (AMTC-412) 15' 5" [4.7m] (AMTC-415).</p>	<p>ALTC-2S</p> 	<p>Blank Round Aluminum Pole – Satin anodized extruded aluminum pole. Nominal wall thickness .060" [1.5mm], length 10'3" [3.1m]. Provided with one 1/2" [12.7mm] trade size KO at base. T-bar mounting hardware, ceiling trim kit, foot assembly, and grommet included. Feed box not furnished.</p>
<p>NP800C-10-2B NP800C-12-8B NP800C-15-2B</p> 	<p>Blank Aluminum Pole – Two-compartment large capacity pole. Furnished unwired without outlets. Box ended with industry sized knockouts.</p> <p>Standard heights: 10'2" [3.1m] (NP800C-10-2B), 12'8" [3.9m] (NP800C-12-8B), 15'2" [4.6m] (NP800C-15-2B).</p> <p>Other heights available – consult factory. 30" [762mm] communication cover with industry standard knockouts.</p>		

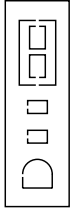
Accessories for Aluminum Tele-Power Poles Ordering Information

Catalog No./Item	Description/Specifications	Catalog No./Item	Description/Specifications						
AMDTP-A 25DTP-A 	Add-On Power Cover – Add power receptacles or devices to existing modular Tele-Power Poles. Includes receptacle mounting bracket. Face diameter of single receptacle: 1.38" - 1.40" [35mm - 36mm].	30TP-C 	Single Gang Cover – Accepts up to 30A shallow-style device and flushplate. G3007 Device Bracket included. Ivory finish. Used to mount industry standard straight and angled communication faceplates.						
	<table border="1" style="margin-left: auto; margin-right: auto;"> <thead> <tr> <th style="width: 20%;">COLOR</th> <th style="width: 20%;">DIMENSIONS</th> </tr> </thead> <tbody> <tr> <td>25DTP-A Ivory Steel (25DTP-4)</td> <td>1" x 2 1/4" x 28"</td> </tr> <tr> <td>AMDTP-A Anodized Aluminum (AMDTP-4)</td> <td>[25mm x 57mm x 711mm]</td> </tr> </tbody> </table>	COLOR	DIMENSIONS	25DTP-A Ivory Steel (25DTP-4)	1" x 2 1/4" x 28"	AMDTP-A Anodized Aluminum (AMDTP-4)	[25mm x 57mm x 711mm]	30TP-J 	Single Receptacle Cover – For field installation of single receptacles with face diameters of 1.56" [40mm] diameter. G3007 Device Bracket included. Ivory finish.
COLOR	DIMENSIONS								
25DTP-A Ivory Steel (25DTP-4)	1" x 2 1/4" x 28"								
AMDTP-A Anodized Aluminum (AMDTP-4)	[25mm x 57mm x 711mm]								
AMDTP-B 25DTP-B 	Add-On Power Cover – Add power receptacles or devices to existing modular Tele-Power Poles. Includes receptacle mounting bracket.	30TP-L 	Rectangular Device Cover – Rectangular faceplate to accommodate Sentrex surge receptacles, GFCI and other decorator style devices. G3007 Device Bracket included. Ivory finish.						
	<table border="1" style="margin-left: auto; margin-right: auto;"> <thead> <tr> <th style="width: 20%;">COLOR</th> <th style="width: 20%;">DIMENSIONS</th> </tr> </thead> <tbody> <tr> <td>25DTP-B Ivory Steel (25DTP-4)</td> <td>1" x 2 1/4" x 28"</td> </tr> <tr> <td>AMDTP-B Anodized Aluminum (AMDTP-4)</td> <td>[25mm x 57mm x 711mm]</td> </tr> </tbody> </table>	COLOR	DIMENSIONS	25DTP-B Ivory Steel (25DTP-4)	1" x 2 1/4" x 28"	AMDTP-B Anodized Aluminum (AMDTP-4)	[25mm x 57mm x 711mm]	25DTC-3S2 	Data & A/V Add-On Cover for 25DTP Series Poles – Accepts Ortronics® Series II Modular Connectivity Solutions.
COLOR	DIMENSIONS								
25DTP-B Ivory Steel (25DTP-4)	1" x 2 1/4" x 28"								
AMDTP-B Anodized Aluminum (AMDTP-4)	[25mm x 57mm x 711mm]								
AMDTP-L 25DTP-L 	Add-On Power Cover – Add power receptacles or devices to existing modular Tele-Power Poles. Includes receptacle mounting bracket.	25DTC-CVR 	Data & A/V Add-On Cover for 25DTP Series Poles – Accepts discrete jacks.						
	<table border="1" style="margin-left: auto; margin-right: auto;"> <thead> <tr> <th style="width: 20%;">COLOR</th> <th style="width: 20%;">DIMENSIONS</th> </tr> </thead> <tbody> <tr> <td>25DTP-L Ivory Steel (25DTP-4)</td> <td>1" x 2 1/4" x 28"</td> </tr> <tr> <td>AMDTP-L Anodized Aluminum (AMDTP-4)</td> <td>[25mm x 57mm x 711mm]</td> </tr> </tbody> </table>	COLOR	DIMENSIONS	25DTP-L Ivory Steel (25DTP-4)	1" x 2 1/4" x 28"	AMDTP-L Anodized Aluminum (AMDTP-4)	[25mm x 57mm x 711mm]	30TP-A 	Single Receptacle Cover – Single receptacle cover for field installation of receptacles with face diameters of 1.38" - 1.40" [25mm - 36mm]. G3007C Device Bracket included. Ivory finish.
COLOR	DIMENSIONS								
25DTP-L Ivory Steel (25DTP-4)	1" x 2 1/4" x 28"								
AMDTP-L Anodized Aluminum (AMDTP-4)	[25mm x 57mm x 711mm]								
30TP-B 	Duplex Receptacle Cover – For installations of 15A and 20A duplex receptacles. G3007C Device Bracket included. Ivory finish.	30TC-CVR 	Data & A/V Add-On Cover for 30TC Series Poles – Accepts discrete jacks.						

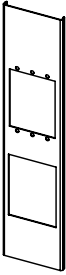
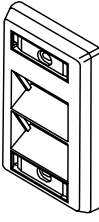
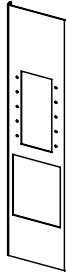
Accessories for Aluminum Tele-Power Poles Ordering Information (continued)

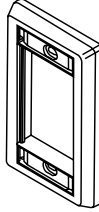
Catalog No./Item	Description/Specifications	Catalog No./Item	Description/Specifications
30TP-AAP	 <p>Add-On A/V Cover – Accepts three (3) Extron® Electronics AAP plates 12" L x 2.75" W [305mm x 70mm]. Includes three adapters to accommodate Ortronics® or Wiremold Open System devices.</p>	CM-SAP	 <p>Data & A/V Add-On Cover for 30TC Series Poles – Single-gang, angled faceplate accepts CM Series Connectors. (Requires 30TP-C Mounting Plate.)</p>
30TP-MAAP	 <p>Add-On A/V Cover – Accepts five (5) Extron® Electronics MAAP plates 12" L x 2.75" W [305mm x 70mm]. Includes three adapters to accommodate Ortronics® or Wiremold Open System devices.</p>	25AM10FO	 <p>Data & A/V Add-On Cover for 25DTP Series Poles – 2" [51mm] radius control Entrance End Fitting.</p>
CM-SFP	 <p>Data & A/V Add-On Cover for 30TC Series Poles – Single-gang faceplate accepts CM Series Connectors. (Requires 30TP-C Mounting Plate.)</p>	25AM-AP 30TP-AP	<p>Replacement Accessory Pack – For 25DTP and 25DTC Series Poles (25AM-AP) or 30TP-2 and 30TP-4 Series Poles (30TP-AP). Includes: gripper pad, ceiling trim plate, bracket and grommet.</p>

Aluminum Vertical Drop Poles Ordering Information (continued)

Catalog No./Item **Description/Specifications**

NP800

Jumbo Tele-Power Pole – Two separate compartments can accommodate up to 60A devices (#6 AWG maximum). Snap-in divider permits up to six channels of varying sizes.

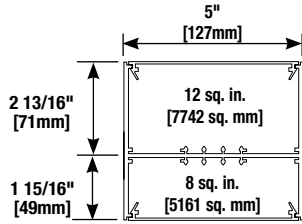

General Specifications:

Receptacles: Each pole compartment may be wired with up to 12 receptacles, with the number of circuits limited by the feed method.

Feed method: All poles are provided with a utility box (4" x 4" x 2 1/8" [102mm x 102mm x 54mm]) for all poles with a cord up to 10' [3m].

Accessories: Ceiling trim plates, pole clamp, and non-adjustable foot with carpet gripper/adhesive pad furnished.

NP800 SERIES WIRE FILL CAPACITIES FOR COMMUNICATIONS

CABLE TYPE Description Nom. O.D. Inches	UNSHIELDED TWISTED PAIR (24 AWG)					SHIELDED TWISTED PAIR				COAXIAL CABLE				TWINAX	FIBER*
	Cat 3 2 Pair 0.14	Cat 3 3 Pair 0.15	Cat 3 4 Pair 0.19	Cat 5 4 Pair 0.22	Cat 6 4 Pair 0.25	Cat 3 4 Pair 0.41	Type 1 22 AWG 0.39	Type 2 22 AWG 0.465	Type 3 22 AWG 0.245	RG58/U 20 AWG 0.195	RG58/U 22 AWG 0.242	RG6/U 22 AWG 0.242	RG6/U 18 AWG 0.27	100 OHM 0.33	0.19
Capacity of Cross-Section (IN ²)															
2.4	62	54	33	25	19	7	8	5	20	32	20	20	16	11	33
2.8	72	63	39	29	22	8	9	6	23	37	24	24	19	13	39
3.2	83	72	45	33	26	9	10	7	27	42	27	27	22	14	45
4.2	109	95	59	44	34	12	14	9	35	56	36	36	29	19	59
4.3	111	97	60	45	34	13	14	10	36	57	37	37	30	20	60
4.8	124	108	67	50	38	14	16	11	40	64	41	41	33	22	67
5.0	129	113	70	52	40	15	16	11	42	66	43	43	34	23	70
5.2	135	117	73	54	42	15	17	12	44	69	45	45	36	23	73
5.8	150	131	81	61	46	17	19	13	49	77	50	50	40	27	81
6.2	161	140	87	65	50	18	20	14	52	83	53	53	43	28	87
7.0	181	158	98	73	56	21	23	16	59	93	60	60	48	32	98
7.7	200	174	108	81	62	23	25	18	65	103	66	66	53	36	108
8.0	207	181	112	84	64	24	26	18	67	107	69	69	55	37	112
12.0	311	271	169	126	96	36	40	28	101	160	104	104	83	56	169

* Two Strand (Duplex) Multimode, 625/125µm. Capacity range is calculated at 40% of raceway areas as stated in the Commercial Buildings Standard for Telecommunication Pathways and Spaces, EIA/TIA 569-A.

NP800 SERIES WIRE FILL CAPACITIES FOR POWER

	WIRE SIZE THHN/THWN	40% FILL	CIRCUITS
POWER WIRING	10 AWG	12	4
	12 AWG	13	4
	14 AWG	15	5

NOTES: Wire fill capacities calculated for a pole with a 4" x 4" x 2 1/8" [102mm x 102mm x 54mm] box. Larger boxes can be used if higher capacity is needed.

All of the standard profiles can be easily modified. Contact the factory or the field sales representative for specifics.

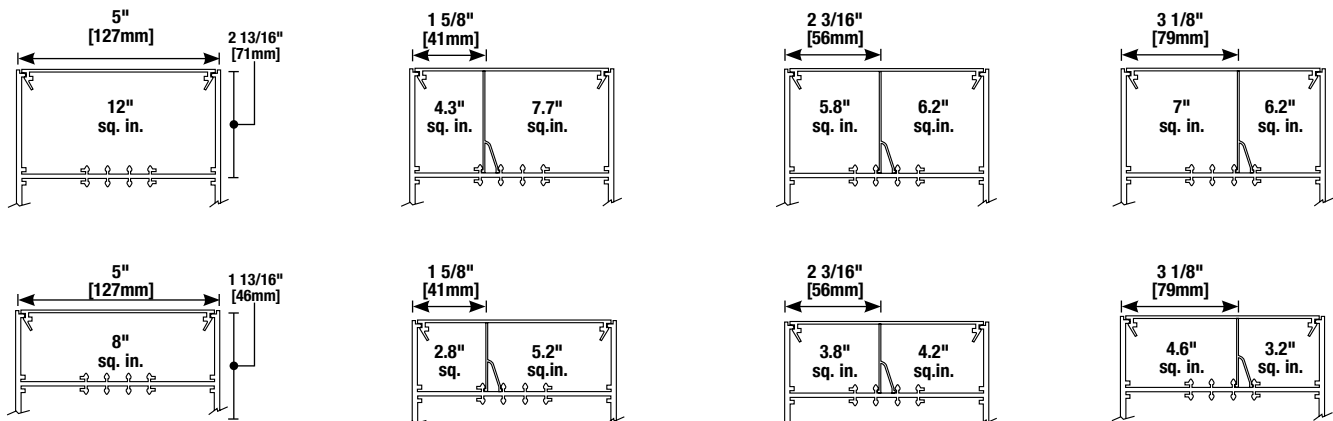

NOTES

NOTES



Electrical Wiring Systems

60 Woodlawn Street
West Hartford, CT 06110
Phone: 1.877.BY.LEGRAND (295-3472)
www.legrand.us

570 Applewood Crescent
Vaughan, Ontario L4K 4B4
Phone: 905.738.9195
www.legrand.ca

