

Magnetic Switches

60 Series



Edwards magnetic switches are designed to activate a variety of signaling devices. Normally open circuits close when the magnet engages. SPDT switches are for open circuit systems or for central office operation. Normally closed circuits open when the magnet engages. For accessories, see Magnetic Switch Accessories, page 10-24.

Used for commercial, industrial, and residential burglar alarm systems.

FEATURES

- > Normally open , normally closed or SPDT switches available
- Cat. No. 63 magnetic switch is supplied complete with 66-W Insulating Spacer, 67W Terminal Cover, and mounting hardware

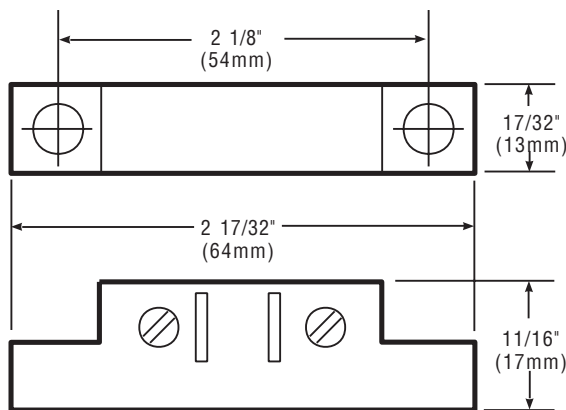

Cat. No.	Description	Color	Rating
60	Normally Open Switch	Gray	100 V, 50 mA
61	SPDT Switch	Gray	30 V, 250 mA
62	Normally Closed Switch	Gray	30 V, 250 mA
63	Normally Open switch	White	100 V, 50 mA
64	SPDT Switch	White	30 V, 250 mA
65	Normally Closed Switch	White	30 V, 250 mA