

B36IC

6" Slope IC Housing

LAMP WATTAGE: (1) MAXIMUM 75W R/PAR30, 60W A19, 65W BR30

Catalog Number:

Project Name:

Type:

Note:

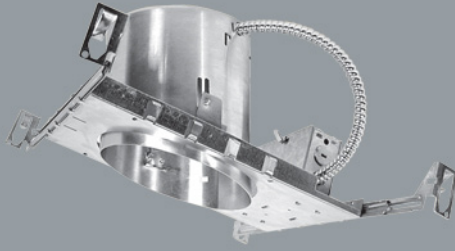

DESIGNED FOR 2" X 8" JOIST CONSTRUCTION

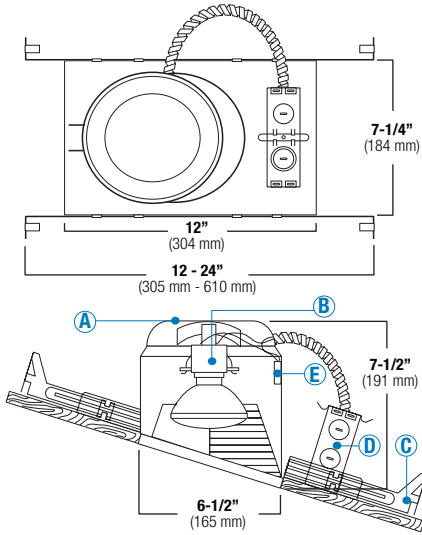

DESCRIPTION

New construction, thermally protected, IC rated specification grade recessed housing. Designed for sloped ceiling applications where the ceiling pitch ranges from 2/12 to 6/12. Accommodates up to 75W PAR30, R30 lamps, 60W A19 lamps and 65W BR30 lamps. Furnished with preinstalled adjustable bar hangers. Junction box is provided with four 1/2" KOs, one 3/4" KO and four Romex knockouts with strain relief.

SPECIFICATION

A. HOUSING - Die-formed all aluminum construction for maximum heat dissipation and rust protection. Adjusts vertically in plaster frame to accommodate 1/2" to 1-3/8" ceilings.

B. SOCKET - Medium base screw shell porcelain socket preinstalled on a mounting bracket is specially designed to swivel and rotate so the lamp could be aligned properly. The lamp will aim straight down regardless of the ceiling pitch.

C. BAR HANGERS - Preinstalled bar hangers allow housing to be positioned and locked at any point within a 24" joist span and can be shortened for 12" joists. Integral bar hanger nailers are designed to be hammered directly into the joist without additional nails or screws and makes installation fast and accurate. Bar hangers can fit onto T-Bar spline with additional slots and holes for special mounting methods if necessary.

D. JUNCTION BOX - ETL listed for through-branch circuit wiring and has four 1/2" KOs, one 3/4" KO and four Romex knockouts with true pry-out slots and strain clamps.

E. THERMAL PROTECTION - Standard thermal protection device guards against improper installation, over-lamping and misuse of insulation material.

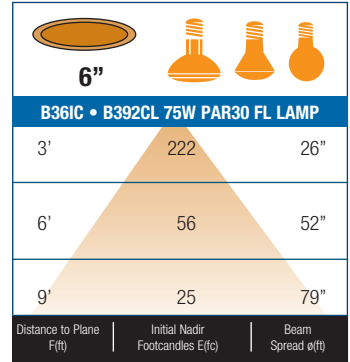

FEATURES

- Thermally Protected IC housing.
- The socket bracket is specially designed to swivel and rotate so the lamp could be aligned properly. The lamp will aim straight down regardless of the ceiling pitch.
- Adjustable socket bracket with a slope indicator provides consistent lamp alignment and setup.
- Wire through junction box.
- Preinstalled adjustable bar hanger.
- Dependable, favorable design and effortless installation.
- 7-1/2" height allows use in 2" x 8" joist construction.
- Preinstalled socket cap provides electrical contact protection against dust, paint and over spray.

OPTIONS

AIR-SHUT

- Gasket to prevent air flow from heated or air conditioned spaces.
- Meets all national air flow requirements.

ETL AND C-ETL LISTED

- For Damp location
- For Feed-through wiring
- For Direct contact with insulation



ITEM SELECTOR: (Please check the boxes below for the option desired)

TYPE	AIR-SHUT	TRIM TYPE	BAFFLE	REFLECTOR	TRIM/RING
B36IC	<input type="checkbox"/> AT	<input type="checkbox"/> B391 <input type="checkbox"/> B392 <input type="checkbox"/> B602 <input type="checkbox"/> B646 <input type="checkbox"/> B663 <input type="checkbox"/> B673 <input type="checkbox"/> B601 <input type="checkbox"/> B601L <input type="checkbox"/> B605 <input type="checkbox"/> B605L	<input type="checkbox"/> W <input type="checkbox"/> P <input type="checkbox"/> SN <input type="checkbox"/> CP <input type="checkbox"/> BZ	<input type="checkbox"/> CL <input type="checkbox"/> RG <input type="checkbox"/> W <input type="checkbox"/> MB <input type="checkbox"/> BZ <input type="checkbox"/> CP <input type="checkbox"/> SN <input type="checkbox"/> SHZ	<input type="checkbox"/> WH <input type="checkbox"/> BK <input type="checkbox"/> SN <input type="checkbox"/> CP <input type="checkbox"/> CH <input type="checkbox"/> PB <input type="checkbox"/> BZ

Specifications:

B36IC

AIR-SHUT OPTION TRIM TYPE BAFFLE REFLECTOR TRIM/RING GLASS

BAFFLE	REFLECTOR	TRIM/RING
W White	CL Chrome	WH White
P Black	RG Gold	BK Black
SN Satin Nickel	W White	SN Satin Nickel
CP Copper	MB Black	CP Copper
BZ Bronze	BZ Bronze	CH Chrome
	CP Copper	PB Polish Brass
	SN Satin Nickel	BZ Bronze
	SHZ Satin Haze	

Sample of Catalog Number: B36IC-AT-B391-W-WH

*For custom baffle, reflector, trim ring, glass color and lens options, please consult factory.



Submittal form is available @ www.iuseelite.com
Tel: 323-888-1973 • Fax: 323-888-1977

Specifications and Dimensions subject to change without notice.

REV: ELITE LIGHTING-SPEC-06-29-2011

6" Slope Ceiling Incandescent Trims

(LAMP WATTAGE: (1) MAXIMUM 75W R/PAR30, 60W A19, 65W BR30)

Catalog Number:

Project Name:

Type:

Note:



B391CP-CP
METAL STEPPED BAFFLE R30/PAR30



BAFFLE FINISH:
W, P, SN, CP, BZ

TRIM/RING FINISH:
WH, BK, SN, CP, CH,
PB, BZ

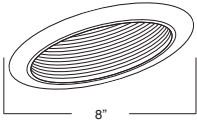

B394P-WH
PAR38/R40 STEPPED BAFFLE

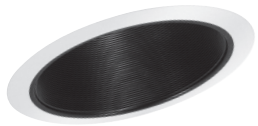

BAFFLE FINISH:
W, P, SN, CP, BZ

TRIM/RING FINISH:
WH, BK, SN, CP, CH,
PB, BZ

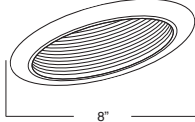

B392RG-WH
R30/PAR30 REFLECTOR



REFLECTOR FINISH:
CL, RG, W, MB, CP,
SN, BZ

TRIM/RING FINISH:
WH, BK, SN, CP, CH,
PB, BZ

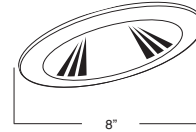

B395CP-WH
R38/PAR40 REFLECTOR



REFLECTOR FINISH:
CL, RG, W, MB, CP,
SN, BZ

TRIM/RING FINISH:
WH, BK, SN, CP, CH,
PB, BZ

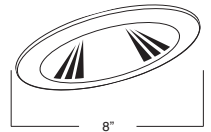

B601CP
METAL ALBALITE LENS



FOR
WET
LOCATION

LENS:
ALBALITE

TRIM/RING FINISH:
WH, BK, SN, CP, CH,
PB, BZ

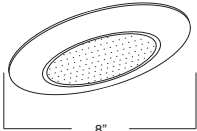

B601L
PLASTIC ALBALITE LENS



FOR
WET
LOCATION

LENS:
ALBALITE

TRIM/RING FINISH:
WHITE PLASTIC

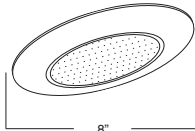

B605PB
METAL FRESNEL LENS



FOR
WET
LOCATION

LENS:
FRESNEL

TRIM/RING FINISH:
WH, BK, SN, CP, CH,
PB, BZ

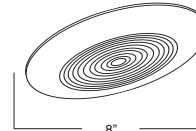

B605L
PLASTIC FRESNEL LENS



FOR
WET
LOCATION

LENS:
FRESNEL

TRIM/RING FINISH:
WHITE PLASTIC

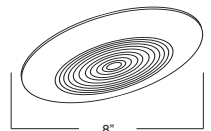

B663PB
PAR30 GIMBAL RING



TRIM/RING FINISH:
WH, BK, SN, CP, CH,
PB, BZ

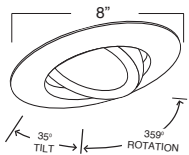

B673P-OV
PAR30 BAFFLE W/ GIMBAL RING

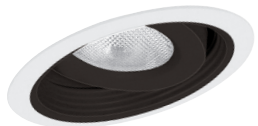

BAFFLE FINISH:
W, P, SN, CP

TRIM/RING FINISH:
WH

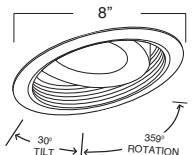

BAFFLE	REFLECTOR	TRIM RING
W White	CL Chrome	WH White
P Black	RG Gold	BK Black
SN Satin Nickel	W White	SN Satin Nickel
CP Copper	MB Black	CP Copper
BZ Bronze	CP Copper	CH Chrome
	SN Satin Nickel	PB Polish Brass
		BZ Bronze

*For custom baffle, reflector, trim ring, glass color and lens options, please consult factory.