

## ADVANCED OPERATION

### Groups

Use a Miro Wireless DRD3 Switch in conjunction with one or more Miro Wireless DRD8 Multilocation Controllers to control one non-dimmable lighting circuit from multiple locations. Binding the DRD3 and DRD8 devices together in the same Group enables them to work in exactly the same way, from any control location.

You can include other Wireless Miro devices in the Group. Just remember that all devices in the Group operate when one member operates.

Set the House ID (see Set House ID) before setting up Groups.

1. Go to any device that you want to include in the Group. Press . The device LED flashes yellow, and all other devices in the House flash green. You now have 5 minutes to complete this process.

2. To include or exclude a device in the Group press  on the device until the LED changes color. **Yellow** flashing LED = Included in the Group  
**Green** flashing LED = NOT included in the Group

If you get to a device and it is NOT flashing, the 5 minute binding process timer may have expired. Go back to step 1 and repeat.

3. Return to the device used in step 1 and press  to terminate Group binding. All LEDs turn solid green.

### Adding a Switch to a Group in an Existing System

1. Go to a device that is in the existing Group where you want to add the switch. Press . The device LED and all members of the Group flash yellow. The new switch flashes green.

2. Press  on the new switch until its LED flashes yellow.

3. Return to the device used in step 1 and press . All LEDs turn solid green.

### Deleting a Switch from a Group in an Existing System

1. Go to a device other than the one you're deleting that is in the existing Group. Press  until the LED flashes yellow on each member of the Group.

2. Press  on the switch you want to remove, until its LED flashes green.

3. Return to the device used in step 1 and press . All LEDs turn solid green.

## Scene Control

The Wireless Miro switch may be easily incorporated into room preset and whole house preset scenes. The **Miro Installation Guide** provides more information about configuring scenes and presets.

Instructions for installation and use are included with the relevant Miro wireless room and whole house control devices. Application support information and the **Miro Installation Guide** is available at [www.legrand.us](http://www.legrand.us) for Legrand customers and [www.vantagecontrols.com](http://www.vantagecontrols.com) for Vantage customers.

## CLEANING

Clean using a cloth dampened only with water and a little mild detergent.

Use of solvents or hydrocarbon-based cleaners may cause permanent damage.

## TROUBLESHOOTING

### During Set House ID, the LED is not flashing on some Miro wireless devices.

- If LED is solid green before initiating house ID binding:  
The device already has another house ID. Reset it to the factory default so that it can be bound to the desired house ID. Resetting to factory defaults is described in the “I need to start over” issue.
- If LED is solid yellow after initiating house ID binding:  
The device may be out of range of the initiating device. Add a MRR2G Miro Wireless Repeater to boost signal range.

### I made a configuration mistake. I need to start over.

You can reset any Miro wireless device to factory default settings by pressing and holding  until the LED changes to solid yellow (approximately 10 seconds). During the process, the LED flashes yellow and when complete, it changes to solid yellow. The device can then be reconfigured, exactly like any new device (see the Set House ID section).

### The switch does not work and the status LED is flashing red at 2Hz (10 times in 5 seconds):

The switch has detected an overload condition and has shut down.

To clear the fault condition, tap  and wait for the LED to turn green.

Disconnect loads in excess of rated load and try again.

## FCC Notice

This equipment has been tested and found to comply with the limits for a Class B digital device, pursuant to part 15 of the FCC Rules. These limits are designed to provide reasonable protection against harmful interference in a residential installation. This equipment generates, uses and can radiate radio frequency energy and, if not installed and used in accordance with the instructions, may cause harmful interference to radio communications. However, there is no guarantee that interference will not occur in a particular installation. If this equipment does cause harmful interference to radio or television reception, which can be determined by turning the equipment off and on, the user is encouraged to try to correct the interference by one or more of the following measures:

- Reorient or relocate the receiving antenna.
- Increase the separation between the equipment and receiver.
- Connect the equipment to an outlet on a circuit different from that to which the receiver is connected.
- Consult the dealer or an experienced radio/TV technician for help.

**Caution:** Any changes or modifications to this device not explicitly approved by manufacturer could void your authority to operate this equipment.

## Warranty Information

Manufacturer warranties its products to be free of defects in materials and workmanship for a period of five (5) years. There are no obligations or liabilities on the part of manufacturer for consequential damages arising out of, or in connection with, the use or performance of this product or other indirect damages with respect to loss of property, revenue or profit, or cost of removal, installation or reinstallation.

**Legrand Customers contact:**

 **legrand**<sup>®</sup>

301 Fulling Mill Road Suite G  
Middletown, PA 17057  
Phone: 800.321.2343  
[www.legrand.us/onq](http://www.legrand.us/onq)

Please  
Recycle



IS-0517

**Vantage Customers contact:**

 V A N T A G E

1061 South 800 East  
Orem, UT 84097  
Phone: 800.555.9891  
[www.vantagecontrols.com](http://www.vantagecontrols.com)

# DRD3 v2

## Wireless Switch



# Installation Instructions

### Specifications

Voltages .....	120/277VAC, 60Hz
Maximum Load Rating	
@120VAC .....	1500W, 1/4hp
@277VAC .....	3000W
Load Type Compatibility	
Non-dimmable fluorescent ballasts	
Discharge lighting fixtures	
Fixtures with integral dimmers	
AC motors and pumps	

U.S. Patent 5,804,991.  
Other patents pending

 **legrand**<sup>®</sup>

 V A N T A G E

## UNIT DESCRIPTION

The Miro Decorator Wireless DRD3 Switch incorporates an electro-mechanical relay that switches the load safely using patented zero-crossing technology.

### Miro Wireless

Miro wireless devices use radio signals to communicate with each other to control lighting and other types of electric loads in selected areas. Miro wireless devices use the 900MHz band for high-speed control communication. Using the patented "frequency-agile" Top Dog™ technology, Miro wireless devices avoid interference with other 900MHz devices, such as cordless phones and baby monitors.

### Load Types

Use the DRD3 for the following load types, up to the maximum load rating for the input voltage:

- Conventional (non-dimmable) fluorescent ballasts
- Discharge lighting fixtures
- Fixtures with integral dimmers
- AC motors and pumps (120VAC only)



### CAUTION

To reduce the risk of overheating and possible damage to other equipment, do not install to control a receptacle.



### CAUTION

Afin de réduire le risque de surchauffe et la possibilité d'endommager d'autres matériels, ne pas installer pour commander une prise.



**CAUTION**



**TURN THE POWER OFF AT THE CIRCUIT BREAKER  
BEFORE INSTALLING THE DEVICE.**

## INSTALLATION

For ease of installation, manufacturer recommends use of a deep wall box. The device is equipped with flying leads to simplify installation, however, if desired, they may be removed by loosening the screw terminals.

1. Disconnect power to circuit by turning circuit breaker OFF before installation.
2. Remove the existing wall plate and switch, if one is present.
3. Strip existing wires 1/2". If two wires will be connected to the same terminal on a Miro device, both wires must be the same gauge (12AWG or 14AWG).
4. Wire the LINE (black), LOAD, NEUT (white) and GND (green or bare) supply and load wires to the correspondingly marked screw terminals, according to the wiring diagram below.
5. Attach the wall plate.
6. Switch the circuit breaker back ON.

**INSTALL IN COMPLIANCE WITH  
ALL APPLICABLE  
CODES & STANDARDS.**

Failure to follow these instructions may cause personal injury or equipment damage.

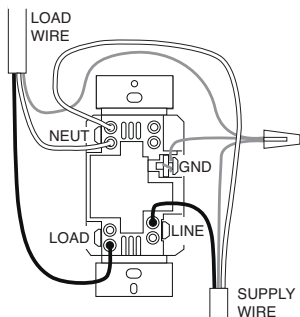



## SET HOUSE ID

### New Installation

All Miro wireless devices installed in the same home must acquire the same unique House ID before use. This process is known as house binding. Each Miro wireless device is bound to all other Miro wireless devices in the house.

### New Installation

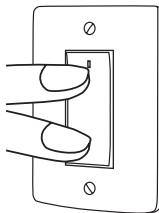

1. With all devices installed and energized, make sure that every Miro wireless device LED is yellow. If any LED is off, be sure the circuit breaker is on and the device is correctly installed.
2. Press  on any device paddle until the LED flashes yellow (about 2 seconds). This indicates that it has acquired a unique House ID.
3. Make sure that all other Miro wireless device LEDs are flashing green, indicating that they have acquired the same House ID.
4. Return to the device used in step 2, which is still flashing yellow. Press  until the LED changes to solid green (about 2 seconds). All device LEDs in the House change to solid green, indicating house binding is complete.



When you see  in the instructions, firmly press and hold both the top and bottom of the device paddle until the LED changes (about 2 seconds).

### Adding a Device to an Existing Installation

If you're adding or replacing a device in a Miro wireless installation that is already operating, the new device must acquire the same House ID as the other Miro wireless devices in the house. After the new device is powered up, the LED should be solid yellow. This indicates that it has not yet acquired a House ID. To acquire the House ID for the existing system:

1. Press  on any **previously bound** device until the LED flashes yellow (about 2 seconds).
2. Verify that the newly added device LED is flashing green, indicating that it has acquired the House ID.
3. Return to the **same previously bound** device used in step 1 and press  until the LED changes to solid green (about 2 seconds). All device LEDs should now be solid green.

## OPERATION

↑	Tap once	Turn circuit ON
—↑—	Press and hold	Turn circuit ON
↓	Tap once	Turn circuit OFF
—↓—	Press and hold	Turn circuit OFF

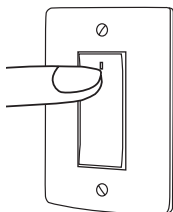

When you see ↑ in the instructions, touch the top of the switch as directed.

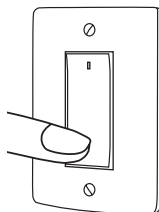

When you see ↓ in the instructions, touch the bottom of the switch as directed.

## Replacing Lamps

When a lamp must be replaced, tap ↓ to turn off the circuit. If you are conducting maintenance on the load, turn off the circuit at the circuit breaker.

## Power Fail Memory

After a power failure, all Miro devices automatically return to the state that they were in immediately prior to loss of power. All configuration and scene control information is preserved.



REV	DESCRIPTION	INT:	REV. DATE	APPROVED
1	ECO# C01933	MJS	3/28/07	CG
2	ECO# C02411	MJS		

**TITLE BOX PAGE ONLY.**  
**DO NOT MAKE FILM • DO NOT PRINT**

- Print: 2-sides
- Ink Color: Black
- Paper: White 16lb (60g/m sq)  
Uncoated, prefer recycled stock
- Final trim size: 16" (Wide) x 6" (High).
- Four (4) fold.
- Final folded size: 4" (Wide) x 6" (High).

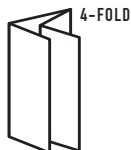



IF YOU HAVE ANY QUESTIONS REGARDING SPECIFICATIONS OR REQUIRE ADDITIONAL FILE FORMATTING, PLEASE CONTACT Mary Jo Sowinski.

Phone: 408-486-7511

Email: maryjo.sowinski@wattstopper.com

**All information in this drawing is the property of Watt Stopper/Legrand and cannot be copied or used without the written approval of Watt Stopper/Legrand.**

Drawn by	SOWINSKI	 <b>Watt Stopper</b>    <b>legrand</b> <sup>®</sup> SANTA CLARA, CALIFORNIA						
PLM								
MarCom								
Engineering								
QA								
TITLE BOX PG Scale: 1:1		Title: DRD3 v2 Installation Instructions						
		<table border="1" style="width: 100%;"> <tr> <td style="width: 30%;">Drawinga #:</td> <td style="width: 40%;">Orig. Drawing Date: 16 MAR 07</td> <td style="width: 30%;">Rev. #:</td> </tr> <tr> <td></td> <td>Revision Date: 24 SEP 07</td> <td></td> </tr> </table>	Drawinga #:	Orig. Drawing Date: 16 MAR 07	Rev. #:		Revision Date: 24 SEP 07	
Drawinga #:	Orig. Drawing Date: 16 MAR 07	Rev. #:						
	Revision Date: 24 SEP 07							