



# 4" MINIATURE UNIVERSAL TC NEW CONSTRUCTION HOUSING

INCANDESCENT LAMPS

**TC1**

Project: \_\_\_\_\_

Fixture Type: \_\_\_\_\_

Location: \_\_\_\_\_

Contact/Phone: \_\_\_\_\_

## PRODUCT DESCRIPTION

TC New Construction Housing design for use in non-insulated areas • If installed where insulation is present, the insulation must be pulled back 3" from all sides of the TC housing.

## PRODUCT SPECIFICATIONS

**Lamp** Lamp ratings based on trim selected – see reverse side.

**Socket** Detachable medium base porcelain with nickel-plated copper screw shell.

**Trims** Trim selection shown on reverse side.

**Labels** U.L. listed for through-branch wiring, damp locations and IP • Product thermally protected against improper use of lamps or insulation • Union made • UL Listed/CSA certified • Trim No. 11, 12, 4101, 4102 and 4181 are wet location approved for covered ceiling applications • Trims 14, 17 are wet location approved for covered ceiling applications, **when used with outdoor rated lamps**.

**Testing** All reports are based on published industry procedures; field performance may differ from laboratory performance.

Product specifications subject to change without notice.

## INSTALLATION

**Real Nail 3 Bar Hangers** Telescoping Real Nail® 3 system covered under Patent D552,969 permits quick placement of housing anywhere within 24" O.C. joists or suspended ceilings • Integral T-bar notch and clip secures housing in suspended ceiling grid – no accessory clips required • 24" expansion stop allows quick placement of fixture in standard grid spacing • Bars scored in two locations for fast, clean breaking, allowing housing installation in tight applications • Bars captive to mounting frame • Edge-mounted for extra strength • Captive bugle-headed ring shank nail for quick one-step installation and easy removal with claw hammer for fixture relocation • Quick-Loc slot (location identified on the mounting frame) and oversized locking set screw lock fixture in position • Bar hanger foot contoured to align to bottom of construction joist • Alternate mounting holes included.

**Junction Box** Pre-wired junction box provided with (5) ½" and (1) ¾" knockouts, (4) Non-metallic sheathed cable connectors and ground wire, U.L. listed/CSA certified for through-branch wiring, maximum 8 No. 12 AWG 90° C branch circuit conductors (4 in, 4 out) • Junction box provided with removable access plates • Knockouts equipped with pryout slots.

**Mounting Frame** 22-gauge die-formed galvanized steel mounting frame • 9½" L x 6¾" W, (excluding bar hangers) • Rough-in section (junction box, mounting frame, housing and bar hangers) fully assembled for ease of installation.

**Housing** TC housing, 22-gauge galvanized steel • Housing is vertically adjustable to accommodate up to a 1¼" ceiling thickness.

## DIMENSIONS

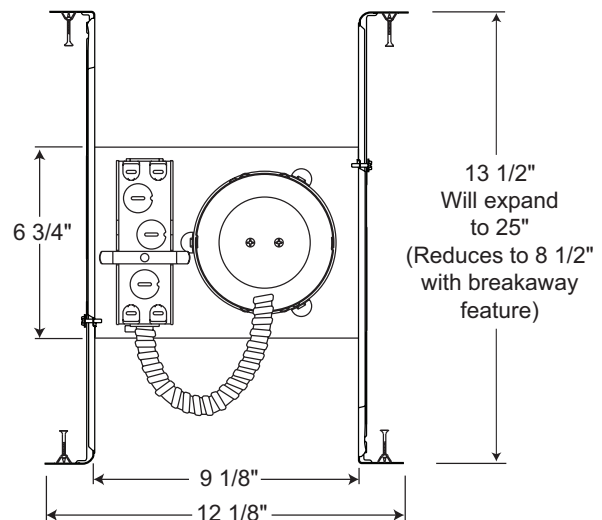
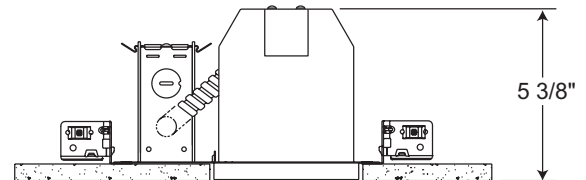

4 1/2" CEILING CUTOUT

## ACCESSORIES

Catalog No.	Description
4TSA	Torsion Spring Adapter (for original style housing)
GU10-WHIP	GU10 Socket Whip

To order, specify catalog number.

## PRODUCT CODES











Catalog Number	Input Voltage	Lamp Rating (max.)
TC1	120V	R14/R16/R20/PAR16/PAR20 (See reverse for max. trim rating)

# 4" MINIATURE UNIVERSAL TC NEW CONSTRUCTION HOUSING

## INCANDESCENT LAMPS

### TC1

#### ROUND TRIMS/LAMPS

Cat. No.	Description	Max. Lamp Rating
 <b>13-WH</b>	2" Pinhole with Integral Shield	50W PAR20/50W R20
 <b>14B-WH ◆◆</b> <b>14B-SC ◆◆</b> <b>14B-ABZ ◆◆</b> <b>14B-BL ◆◆</b> <b>14W-WH ◆◆</b>	Black Baffle Black Baffle Black Baffle Black Baffle White Baffle	50W PAR20/50W R20
 <b>17C-WH ◆◆</b> <b>17G-WH ◆◆</b> <b>17B-WH ◆◆</b> <b>17PT-SC ◆◆</b> <b>17W-WH ◆◆</b> <b>17HZ-WH ◆◆</b> <b>17WHZ-WH ◆◆</b> <b>17WHZ-ABZ ◆◆</b>	Cone - Clear Alzak® Cone - Gold Alzak® Cone - Black Alzak® Cone - Pewter Alzak® Cone - Gloss White Cone - Haze Cone - Wheat Haze Cone - Wheat Haze	50W PAR20/50W R20
 <b>10-WH</b> <b>10-BL</b> <b>10-SC</b> <b>10-ABZ</b>	Push-In Flush Gimbal Ring Push-In Flush Gimbal Ring Push-In Flush Gimbal Ring Push-In Flush Gimbal Ring	50W PAR20/ 75W ES20 GU10 (Requires GU10-WHIP)
 <b>18-WH</b> <b>18-SC</b>	Mini Eyeball Mini Eyeball	60W PAR16, 40W R16
 <b>19-WH</b>	Mini Eyeball	40W R14/40W R16 intermediate screw base
 <b>440-WH</b> <b>440-BL</b> <b>440-SC</b> <b>440-ABZ</b>	Flush Gimbal Ring Flush Gimbal Ring Flush Gimbal Ring Flush Gimbal Ring (New tighter gap, uses 2" optical media)	50W MR16, 50W PAR16, 50W ES16 GU10 (Requires GU10-WHIP)
 <b>445-WH</b>	Slot Aperture Downlight or Adjustable	50W MR16, 50W PAR16, 50W ES16 GU10 (Requires GU10-WHIP)
 <b>448-WH</b> <b>448-SC</b>	Eyeball with Black Baffle Eyeball with Black Baffle	50W MR16, 50W PAR16, 50W ES16 GU10 (Requires GU10-WHIP)
 <b>11-WH ◆</b>	Drop Opal	50W PAR20/50W R20
 <b>12W-WH ◆</b> <b>12W-SC ◆</b> <b>12W-ABZ ◆</b>	Shower Trim, frosted perimeter lens Shower Trim, frosted perimeter lens Shower Trim, frosted perimeter lens	50W PAR20/50W R20

Trim Size: 5" O.D.









**Trim Finish:** ABZ - Classic Aged Bronze, BL - Black, GP - Graphite,  
PW - Plastic White (Polycarbonate material shower trim),  
SC - Satin Chrome, SL - Silver, WH - White.

Alzak is a registered trademark of Alcoa Corp.





Note: In Canada when insulation is present, Type IC fixtures must be used.

◆ UL Listed for use in wet location.

◆◆ UL Listed for use in wet location with outdoor rated lamp.

Cat. No.	Description	Max. Lamp Rating
 <b>16-WH</b>	Scoop Wall Wash with higher inner shield	40W R14/40W R16 intermediate screw base
 <b>446-WH</b>	Scoop Adjustable	50W MR16, 50W 50W ES16 GU10 (Requires GU10-WHIP)
 <b>4101-WH ◆</b> <b>4101-SC ◆</b> <b>4101-ABZ ◆</b>	Beveled Dome Shower Beveled Dome Shower Beveled Dome Shower	50W PAR/50W R20
 <b>4102-WH ◆</b> <b>4102-SC ◆</b> <b>4102-ABZ ◆</b>	Beveled Shower Beveled Shower Beveled Shower	50W PAR/50W R20
 <b>4103FROST-WH</b> <b>4103FROST-SC</b>	Beveled Cylinder Beveled Cylinder	50W PAR/50W R20
 <b>4104HZ-SC</b> <b>4104WHZ-ABZ</b>	Beveled Cone Beveled Cone	50W PAR/50W R20
 <b>4150MESH-SC</b>	Cylinder	50W PAR/50W R20
 <b>4180FROST</b>	Solid Glass Collar (torsion spring attachment)	50W PAR/50W R20
 <b>4181CLEAR ◆</b>	All Glass Shower (torsion spring attachment)	50W PAR/50W R20

#### SQUARE TRIMS/LAMPS

Cat. No.	Description	Max. Lamp Rating
 <b>175Q-HZ-WH ◆◆</b> <b>175Q-W-WH ◆◆</b> <b>175Q-B-WH ◆◆</b> <b>175Q-WHZ-WH ◆◆</b>	Square Downlight	50W PAR20, 30W R20
 <b>135Q-WH</b>	Square Pinhole	50W PAR20, 50W R20
 <b>4405Q-WH</b> <b>4405Q-BL</b>	Square Flush Gimbal	50W MR16 120V GU10 Base (Requires GU10-WHIP) 35° Vertical Adjustment
 <b>125Q-W-WH ◆</b>	Square Frosted Lens with Clear Center	50W PAR20, 50W R20



**GU10-WHIP**

GU10 Socket Whip



1300 S. Wolf Road • Des Plaines, IL 60018 • Phone (847) 827-9880 • Fax (847) 827-2925  
220 Chrysler Drive • Brampton, Ontario • Canada L6S 6B6 • Phone (905) 792-7335 • Fax (905) 792-0064  
Visit us at [www.junolightinggroup.com](http://www.junolightinggroup.com)

Printed in U.S.A. ©2014 Juno Lighting, LLC.