



# TRAC-LITES

One Circuit Trac System

Project: \_\_\_\_\_

Fixture Type: \_\_\_\_\_

Location: \_\_\_\_\_

Contact/Phone: \_\_\_\_\_

## TRAC SECTIONS, JOINERS & FEEDS

R2, R4, R6, and R8

### PRODUCT DESCRIPTION

Reduced-profile, single-circuit trac sections for surface or pendant mounting. Compatible with a full range of feed, connector and mounting accessories, as listed on back of this page. Accepts all Trac-Lites and Trac-Master trac fixtures.

### DIMENSIONS



### PRODUCT SPECIFICATIONS

**Construction** Extruded aluminum with thermoplastic insulator

- Injection molded polycarbonate dead-end with set screw
- Standard lengths may be cut-to-length by installer.

**Electrical** Two 12 gauge solid copper conductors • Rated 20

amps at 120 volts • Aluminum channel used as system ground

- One-piece insulator insures consistent conductor spacing for reliable electrical contact
- Insulating bushings supplied at mounting hole locations to prevent shorts to ground.

**Labels** UL/CUL listed.

### PRODUCT INSTALLATION

Debossed polarity line provides visual cue to proper trac, trac connector and fixture alignment • Supplied with toggle bolts for surface mounting • Insulator stays same length as extrusion to simplify field-cutting of trac • Connectors and feeds simply push into trac sections.

Product specifications subject to change without notice.

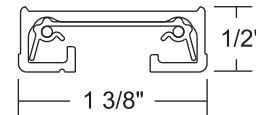
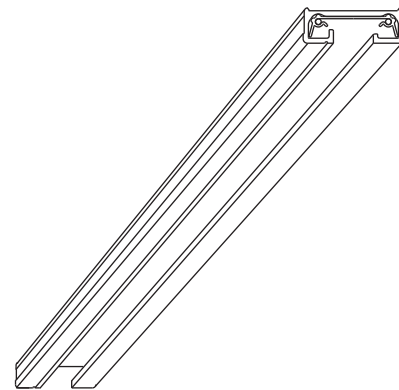

### PRODUCT CODES

Catalog Number	Description	Actual Length	Finish
<b>R2WH</b>	2' Trac Section	19 7/8"	White
<b>R2BL</b>	2' Trac Section	19 7/8"	Black
<b>R2SL</b>	2' Trac Section	19 7/8"	Silver
<b>R2NA</b>	2' Trac Section	19 7/8"	Natural
<b>R4WH</b>	4' Trac Section	43 7/8"	White
<b>R4BL</b>	4' Trac Section	43 7/8"	Black
<b>R4SL</b>	4' Trac Section	43 7/8"	Silver
<b>R4NA</b>	4' Trac Section	43 7/8"	Natural
<b>R6WH</b>	6' Trac Section	67 7/8"	White
<b>R6BL</b>	6' Trac Section	67 7/8"	Black
<b>R6SL</b>	6' Trac Section	67 7/8"	Silver
<b>R6NA</b>	6' Trac Section	67 7/8"	Natural
<b>R8WH</b>	8' Trac Section	91 7/8"	White
<b>R8BL</b>	8' Trac Section	91 7/8"	Black
<b>R8SL</b>	8' Trac Section	91 7/8"	Silver
<b>R8NA</b>	8' Trac Section	91 7/8"	Natural

# TRAC-LITES

One Circuit Trac System

## TRAC SECTIONS, JOINERS & FEEDS

R2, R4, R6, and R8

### Electrical End Feeds

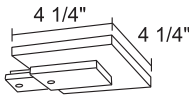

**R21WH, R21BL, R21SL**  
End Feed Connector and Outlet Box Cover. For outlet box feed. Includes: outlet box cover, fixture strap and ground screw.

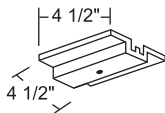

**R29WH, R29BL, R29SL**  
Floating Electrical Feed. Permits mounting any point of trac under outlet box. Includes floating connector, outlet box cover plus extra trac dead end.

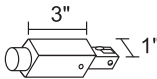

**R34WH, R34BL, R34SL**  
Conduit Feed. For surface wiring. Use standard 1/2" connector.

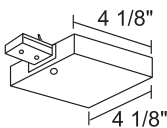

**R36WH, R36BL, R36SL**  
T-Bar End Feed. Wiring compartment contains standard 1/2" KO's. Feeds surface trac from above, when T-bar is directly above trac.

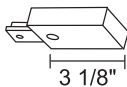

**R38WH, R38BL, R38SL**  
Live End Feed Connector. Feed trac from above with flexible conduit, BX, etc., or end feed in pendant systems. Accepts standard 1/2" connector.

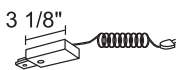

**R22WH, R22BL, R22SL**  
Cord and Plug Connector. Comes with 15' two-wire white cord. Includes surface wire retainers and in-line switch. Max cap. 7 amps.

**R122WH, R122BL, R122SL**  
Same as above but with matching color 3-wire grounded cord and plug. No switch.

### Trac Joiners

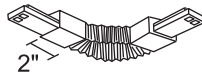

**R20WH, R20BL, R20SL**  
Accordian Adjustable Joiner. Can flex to 90° angle to left, right, up or down. Joins two trac sections.

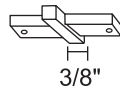

**R23WH, R23BL, R23SL**  
Miniature Straight Connector. Joins two trac sections end to end.

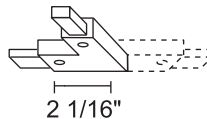

‡ **R24WH, R24BL, R24SL**  
Adjustable Connector. Joins two trac sections to make a 90° angle or straight run. Straight and right angle covers supplied. For outlet box feed, No. **T27** cover plate required.

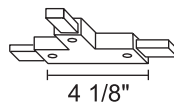

‡ **R25WH, R25BL, R25SL**  
"T" Connector. Joins three trac sections. For outlet box feed, No. **T27** cover plate required.

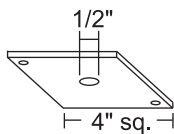

**T27WH, T27BL, T27SL**  
Outlet Box Cover. Use with Nos. **R24/R25** for outlet box electrical feed. Includes: nipple, locknut and ground screw.

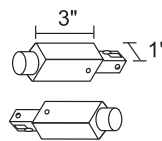

**R49WH, R49BL, R49SL**  
Trac Continuation Kit. Permits trac to continue a run around obstructions. Includes one left and one right **R34** Conduit Feed. Fits standard 1/2" conduit.

### Pendant Stems

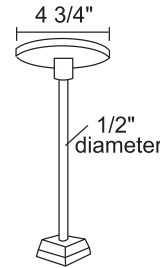

**T90-12, T90-18, T90-24, T90-36, T90-48**  
T-Bar Pendant Stem Kit (12", 18", 24", 36", 48") - Use two for 2', 4', 6' of trac or three for 8' of trac. For electrical feed, order **T93** wireway cover. WH, BL, SL

**T91-12, T91-18, T91-24, T91-36, T91-48**  
Rigid Ceiling Pendant Stem Kit (12", 18", 24", 36", 48") - Use two for 2', 4', 6' of trac or three for 8' of trac. For electrical feed, order **T93** wireway cover. WH, BL, SL

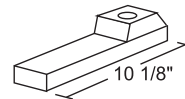

**T93WH, T93BL, T93SL**  
Wireway Cover for Pendant Stem Kits T90 and T91. Conceals electrical feed wires from stem to connector. One cover required for each trac feed.



**T94WH, T94BL, T94SL**  
Sloped Ceiling Adapter. Allows **T90** or **T91** pendant to hang straight down from sloped ceilings. Can be used to feed electrical wires to Trac at up to 60° angle.



**T96WH, T96BL, T96SL**  
Pendant Stem Threaded Coupling. Enables multiple pendant stems to be joined for higher ceiling applications.



**T56WH, T56BL, T56SL**  
Solid Rod Pendant Mounting Kit. Attaches solid 5/16" threaded rod to Trac. Includes: plastic cap, mounting bracket and hardware. Rod not supplied.

### Accessories



**R37F**  
15/16" T-bar Attachment Clip. To attach to inverted tee ceilings using flush tiles. Use two for 2' or 4' trac and three for 6' or 8' trac.

**R37D**  
Same as above with spacer for ceilings using drop tiles.

**R37-9-16**  
9/16" T-bar Attachment Clip. To attach Trac-Lites trac to inverted tee ceilings using flush or drop tiles. Use two for 2' or 4' trac and three for 6' or 8' trac.

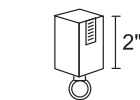

**T31WH, T31BL, T31SL**  
Pendant Adapter. Adapts swag or chain-hung fixture to trac. Supports up to 25 lbs. Not UL Listed.

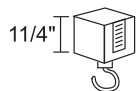

**T32WH, T32BL, T32SL**  
Plant or Utility Hook. Supports up to 25 lbs. Not UL Listed.



**T33WH, T33BL, T33SL**  
Outlet Adapter. Provides electrical receptacle. Not UL Listed.

Product specifications subject to change without notice.

‡ R24 and R25 may not be used as feed connectors in Canada due to special grounding requirements.

