

Wiremold

25DTC/AMTC & 25DTP/AMTP Series Tele-Power® Poles

INSTALLATION INSTRUCTIONS
Installation Instruction No.: 41573R3 - Updated March 2012

Legrand/Wiremold electrical systems conform to and should be properly grounded in compliance with requirements of the current National Electrical Code or codes administered by local authorities.

All electrical products may present a possible shock or fire hazard if improperly installed or used. Legrand/Wiremold electrical products may bear the mark of a Nationally Recognized Testing Laboratory (NRTL) and should be installed in conformance with current local and/or the National Electrical Code.

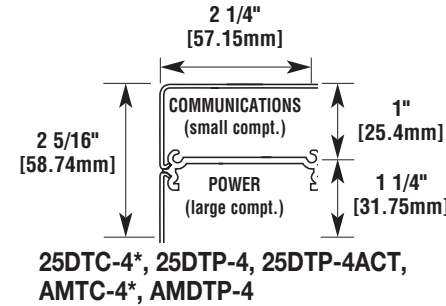

25DTC-4*, 25DTP-4, 25DTP-4ACT,
AMTC-4*, AMDTP-4

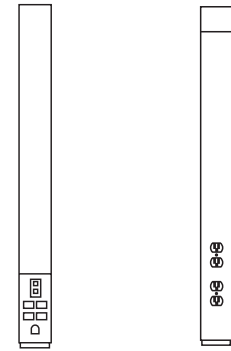

25DTC-4*
AMTC-4*

25DTP-4
AMDTP-4

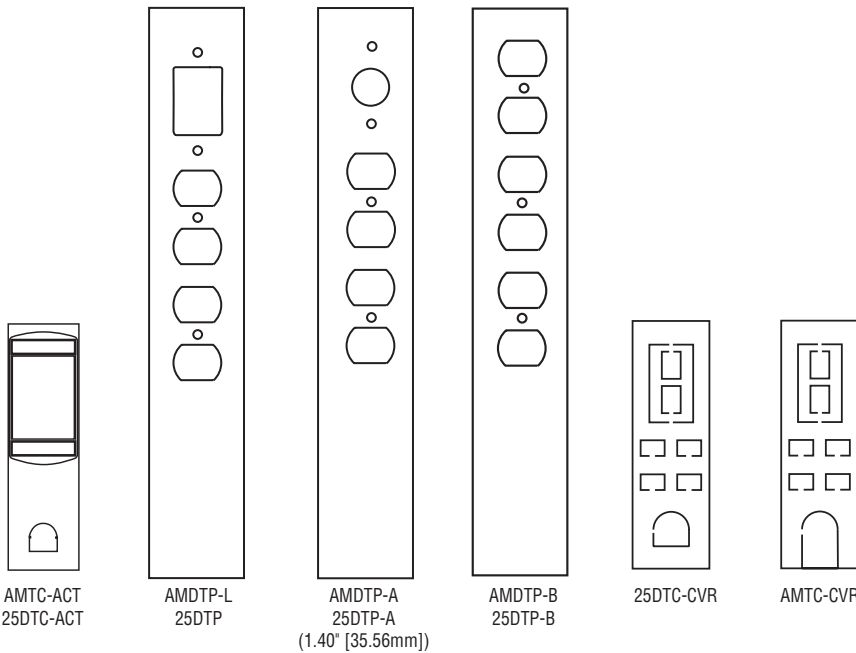

AMTC-ACT
25DTC-ACT

AMDTP-L
25DTP

AMDTP-A
25DTP-A
(1.40" [35.56mm])

AMDTP-B
25DTP-B

25DTC-CVR

AMTC-CVR

RACEWAY WIRE AND CABLE FILL CAPACITIES FOR TELE-POWER POLES - POWER							
Cable Type	Cable Wire/Size Description	O.D.		AMDTP Series	25DTP Series	AMTC & 25DTC Series*	
		(inches)	(mm)			Small Compt.	Large Compt.
THHN / THWN	10 Awg	0.16	4.17	10	10	34	44
	12 Awg	0.13	3.30	15	15	54	69

RACEWAY WIRE AND CABLE FILL CAPACITIES FOR TELE-POWER POLES - COMMUNICATIONS											
Cable Type	Cable Wire/Size Description	O.D.		AMDTP Series		25DTP Series		AMTC & 25DTC Series*			
		(inches)	(mm)	20% FILL	40% FILL	20% FILL	40% FILL	20% FILL	40% FILL	20% FILL	40% FILL
Unshielded Twisted Pair	Cat. 5 UTP	0.22	5.59	10	19	10	19	10	19	13	26
	Cat. 3 UTP	0.19	4.83	13	25	13	25	13	25	17	35
Telephone	2 Pair	0.14	3.56	23	47	23	47	23	47	32	64
	3 Pair	0.15	3.81	20	41	20	41	20	41	28	56
	4 Pair	0.19	4.83	13	25	13	25	13	25	17	35
	25 Pair	0.41	10.41	3	5	3	5	3	5	4	7
Coaxial	RG58/U	0.20	4.95	12	24	12	24	12	24	17	33
	RG59/U	0.24	6.15	8	16	8	16	8	16	11	21
	RG62/U	0.24	6.15	8	16	8	16	8	16	11	21
	RG6/U	0.27	6.86	6	13	6	13	6	13	9	17
TwinAxial	100 Ohm	0.33	8.38	4	8	4	8	4	8	6	12
Shielded Twisted Pair	Type 1 STP	0.39	9.91	3	6	3	6	3	6	4	8
	Type 2 STP	0.47	11.81	2	4	2	4	2	4	3	6
	Type 3 STP	0.25	6.22	8	15	8	15	8	15	10	21
Fiber Optic	Fiber ZipCord	0.11	2.79	38	76	38	76	38	76	52	104
	Round Fiber 2 Strand	0.18	4.57	14	28	14	28	14	28	19	39
	Round Fiber 4 Strand	0.19	4.83	13	25	13	25	13	25	17	35
	Round Fiber 6 Strand	0.21	5.33	10	21	10	21	10	21	14	29

* 25DTC/AMTC Series not intended for combining power and communications in the same channel.



Wiremold

WIREMOLD

U.S. and International:

60 Woodlawn Street • West Hartford, CT 06110
1-800-621-0049 • FAX 860-232-2062 • Outside U.S.: 860-233-6251

Canada:

570 Applewood Crescent • Vaughan, Ontario L4K 4B4
1-800-723-5175 • FAX 905-738-9721

1

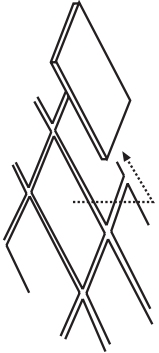

2a

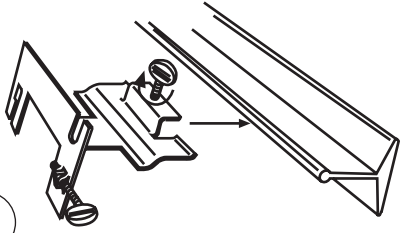

2b

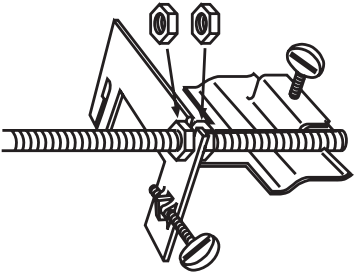

3

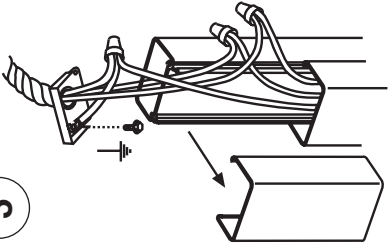

4

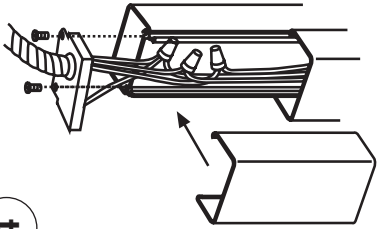

5

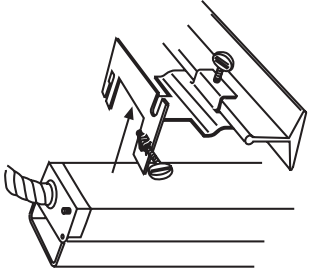

6a

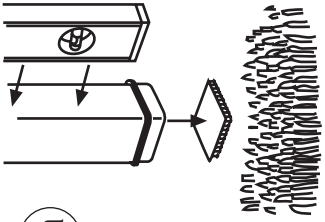

6b

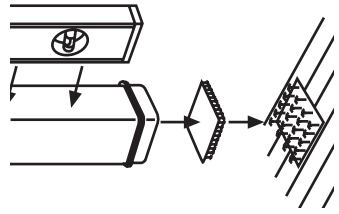

7

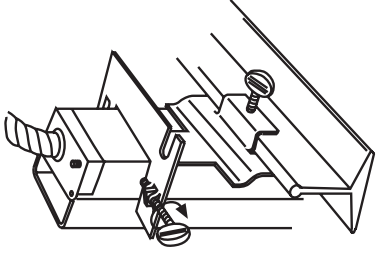

8

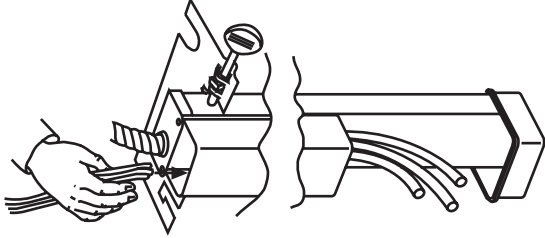

9a

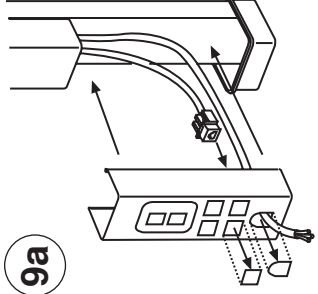

9b

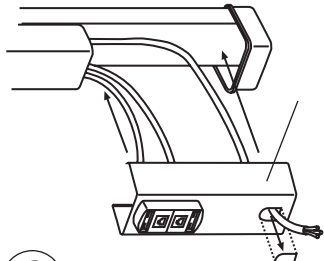

10a

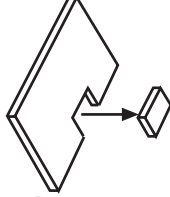

10b



11a

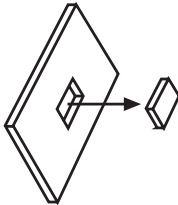

11b

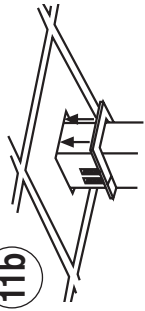

12

