

3777



**UPC Code:** 07847733185

**Country of Origin:** Mexico - \*Eligible for ARRA funded projects > \$7,443,000

**Configuration:**



## Locking Wiring Devices

### Brand Features

Leviton's Industrial Grade Locking Devices are built to provide unparalleled quality and superior performance in the most severe industrial settings. Leviton combines the best materials available with superior production standards to produce a broad selection of Locking Devices of unmatched flexibility and dependability.

### Item Description

50 Amp, 250 Volt DC/600 Volt AC, Non-NEMA, 2P, 3W, Black & White Locking Flanged Inlet, Industrial Grade, Grounding - GRAY METAL

### Technical Information

#### Electrical Specifications

**Grounding:** Grounding

**Amperage:** 50 Amp

**Voltage:** 250 Volt DC/600 Volt AC

**Pole:** 2

**Wire:** 3

**Dielectric Voltage:** Withstands 2000V per UL498

**Maximum Working Voltage:** 250V DC/600V AC as rated

**Temperature Rise:** Max 30°C temp rise at full-rated current after 150 cycles of OL at 150% rated DC current

**Current Interrupting:** Certified for current interrupting at full rated current

#### Environmental Specifications

**Flammability:** Rated V-2 per UL94

**Operating Temperature:** -40deg.C to 75deg.C (-40deg.F to 167deg.F)

#### Material Specifications

**Face Module:** Nylon

**Body & Contract Carrier:** Reinforced Nylon

**Flanged Casing:** Zinc Plated Steel

**Inlet Blade:** 0.100inch thick Brass

**Terminal Block:** 0.062inch thick Copper

**Terminal Set Screw:** SS 302/304

**Ground Shunt:** Bronze

**Grounding Shunt Rivet:** Brass

**Color:** Gray Metal

#### Mechanical Specifications

**Terminal ID:** X, W, Y, Z and Green for ground

**Terminal Accom.:** #10 min to #4max AWG Solid or Stranded Wire

**Product ID:** Ratings and Catalogue No. molded into face

#### Product Features

**NEMA:** Non-NEMA

**Color:** Gray Metal

#### Standards and Certifications

**UL498:** File E13399

**CSA C22.2 No. 42:** File 152105

**NOM:** 057

**RoHS:** Compliant

**Warranty:** Lifetime Limited

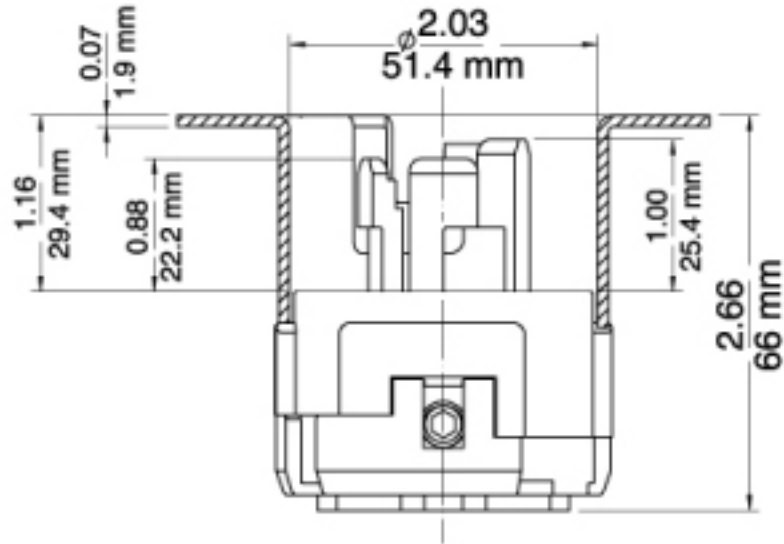
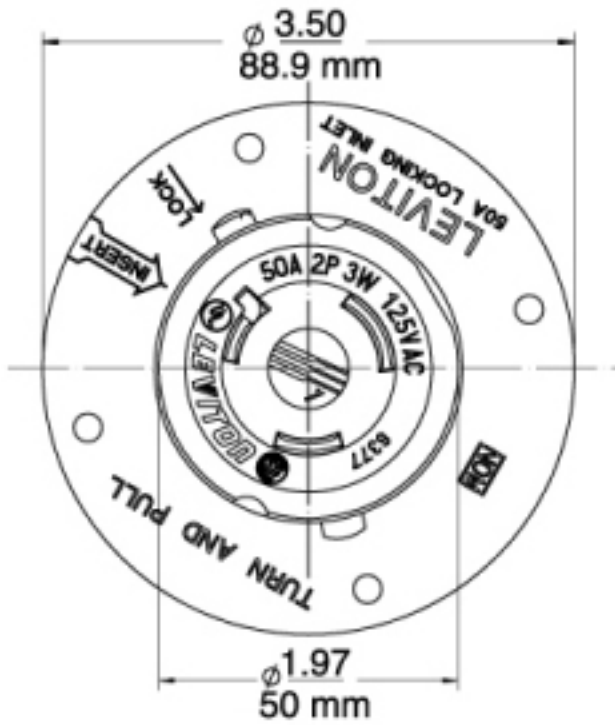

**SPECIFICATION SUBMITTAL**

JOB NAME:	CATALOG NUMBERS:	
JOB NUMBER:		

**Leviton Manufacturing Co., Inc.**  
 201 North Service Road, Melville, NY 11747  
 Telephone: 1-800-323-8920 · FAX: 1-800-832-9538 · Tech Line (8:30AM-7:30PM E.S.T. Monday-Friday): 1-800-824-3005

**Leviton Manufacturing of Canada, Ltd.**  
 165 Hymus Boulevard, Pointe Claire, Quebec H9R 1E9 · Telephone: 1-800-469-7890 ·  
 FAX: 1-800-824-3005 · www.leviton.com/canada

**Leviton S. de R.L. de C.V.**  
 Lago Tana 43, Mexico DF, Mexico CP 11290 · Tel.: (+52)55-5082-1040 · FAX: (+52)5386-1797 · www.leviton.com.mx

Visit our Website at: [www.leviton.com](http://www.leviton.com)  
 © 2012-2014 Leviton Manufacturing Co., Inc. All rights reserved. Subject to change without notice.



**Leviton has a global presence.**  
 If you would like to know where your local Leviton office is located please go to: [www.leviton.com/international/contacts/](http://www.leviton.com/international/contacts/)

*\*Buy American Compliant Logo -- The American Recovery And Reinvestment Act of 2009 ("ARRA") provides federal grants and loans for projects throughout the country. Section 1605 of the Act, named the "Buy American" provision, requires that certain materials and manufactured products used in projects funded by the Act be manufactured in the United States. The appearance of the Recovery Act Logo in relation to a Leviton product is only intended to reflect that such product may be used in an ARRA funded project. It does not mean that such product or Leviton is sponsored or endorsed by, or that Leviton receives funds from, the federal government or the Recovery Accountability and Transparency Board. Nothing in Leviton's use of the logo is intended to suggest anything regarding the requirements for funding under ARRA.*