

L70QS SERIES HIGH-SPEED ROUND BODY FUSES

700 Vac/dc • 35-800 A • Traditional Round Body Bolted Style



Specifications

Voltage Rating	AC: 700V DC: 700V
Amperage Rating	35 - 800 A
Interrupting Rating	AC: 200 kA DC: 50 kA
Time Constant	10ms
Material	Body: Melamine Caps: Copper Alloy (Silver Plated)
Approvals	UL Recognized (E71611) c-UR-us (E71611)
Environmental	RoHS Compliant, REACH
Country of Origin	Mexico

Description

The L70QS Series is a next generation High-Speed Fuse for the protection of power semiconductor devices and is designed in the Traditional North American Bolted Style package.

L70QS Series High-Speed Fuses are extremely current limiting and are used to protect power converters, drives and control circuit applications. Designed with lower I²t performance characteristics, these fuses provide balanced performance to extend longevity while lowering potentially damaging heat energy to the devices being protected.

In addition L70QS Series fuses have been designed with a universal mounting option to meet customer requirements for installation into a variety of application configurations

Littelfuse POWR-SPEED™ products offer optimized circuit protection at the extremely fast speed required to protect modern day, sensitive, high-power semiconductor devices. Such products are commonly found in various industries including pulp and paper industries, cranes and heavy-lifting equipment, processing industries, wastewater treatment plants and large factories and MRO facilities.

Features

- Compliance with US and Canadian Requirements
- Traditional North American Bolted Style dimensions
- Class aR performance
- Direct bus-bar mount or stud mount design
- Halogen Free, RoHS and REACH Compliant

Applications

- Power Converters (Inverters, Rectifiers)
- Power Supplies
- UPS
- Variable Speed Drives
- Control Circuits
- Soft Starters

Part Numbering System

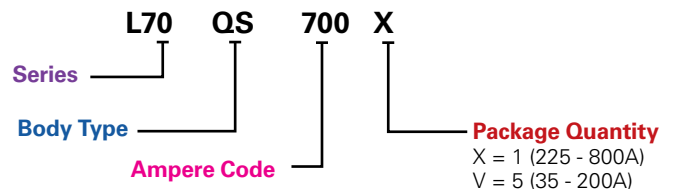

SERIES	BODY TYPE	AMPERE CODE	PACKAGE QUANTITY	CATALOG NUMBER	ORDERING NUMBER
L70	QS	700	1	L70QS700	L70QS700.X

Recommended Fuse Blocks

LSCR001 (35-100A)
LSCR002 (125-800A)



Web Resources

Download technical documents: littelfuse.com/L70QS

L70QS SERIES HIGH-SPEED ROUND BODY FUSES

Electrical Specifications

CATALOG NUMBER	AMPERAGE RATING	VOLTAGE RATING		INTERRUPT RATING		MELTING (PRE-ARC) I ² T (A ² s)	TOTAL CLEARING I ² T (A ² s)	TOTAL CLEARING I ² T (A ² s)	WATTS LOSS AT 80% RATED CURRENT	WATTS LOSS AT 100% RATED CURRENT
		AC	DC	AC	DC		200 kA @ 700 Vac	50 kA @ 700 Vdc	(W)	(W)
L70QS035	35	700	700	200kA	50kA	129	332	308	5	8
L70QS040	40	700	700	200kA	50kA	153	599	416	6	9
L70QS050	50	700	700	200kA	50kA	196	711	588	6	12
L70QS060	60	700	700	200kA	50kA	269	1,233	678	9	15
L70QS070	70	700	700	200kA	50kA	359	1,575	1,075	10	20
L70QS080	80	700	700	200kA	50kA	452	2,755	1,415	12	22
L70QS090	90	700	700	200kA	50kA	625	3,365	1,920	13	25
L70QS100	100	700	700	200kA	50kA	966	3,747	2,347	15	30
L70QS125	125	700	700	200kA	50kA	2,208	8,795	5,570	13	24
L70QS150	150	700	700	200kA	50kA	3,026	13,650	8,195	17	32
L70QS175	175	700	700	200kA	50kA	4,219	19,550	11,650	20	38
L70QS200	200	700	700	200kA	50kA	5,529	22,067	16,100	22	42
L70QS225	225	700	700	200kA	50kA	9,226	34,900	25,400	22	40
L70QS250	250	700	700	200kA	50kA	10,999	43,750	31,650	27	46
L70QS300	300	700	700	200kA	50kA	16,296	64,400	45,500	31	57
L70QS350	350	700	700	200kA	50kA	24,778	91,500	65,250	35	67
L70QS400	400	700	700	200kA	50kA	34,225	110,667	94,666	41	79
L70QS450	450	700	700	200kA	50kA	38,946	145,500	113,500	45	81
L70QS500	500	700	700	200kA	50kA	42,747	173,000	125,500	56	112
L70QS600	600	700	700	200kA	50kA	67,363	220,333	179,667	67	138
L70QS700	700	700	700	200kA	50kA	99,387	368,000	298,000	72	138
L70QS800	800	700	700	200kA	50kA	156,137	466,333	415,333	76	142

Ordering Information

SERIES	AMPERAGE RATING	AMPERE CODE	CATALOG NUMBER	ORDERING NUMBER	PACK QUANTITY	UPC
L70QS	35	035	L70QS035	L70QS035.V	5 Pcs/ Box	07945886015
L70QS	40	040	L70QS040	L70QS040.V	5 Pcs/ Box	07945886016
L70QS	50	050	L70QS050	L70QS050.V	5 Pcs/ Box	07945886017
L70QS	60	060	L70QS060	L70QS060.V	5 Pcs/ Box	07945886018
L70QS	70	070	L70QS070	L70QS070.V	5 Pcs/ Box	07945886019
L70QS	80	080	L70QS080	L70QS080.V	5 Pcs/ Box	07945886020
L70QS	90	090	L70QS090	L70QS090.V	5 Pcs/ Box	07945886021
L70QS	100	100	L70QS100	L70QS100.V	5 Pcs/ Box	07945886022
L70QS	125	125	L70QS125	L70QS125.V	5 Pcs/ Box	07945886023
L70QS	150	150	L70QS150	L70QS150.V	5 Pcs/ Box	07945886024
L70QS	175	175	L70QS175	L70QS175.V	5 Pcs/ Box	07945886025
L70QS	200	200	L70QS200	L70QS200.V	5 Pcs/ Box	07945886026
L70QS	225	225	L70QS225	L70QS225.X	1 Pc/ Box	07945886027
L70QS	250	250	L70QS250	L70QS250.X	1 Pc/ Box	07945886028
L70QS	300	300	L70QS300	L70QS300.X	1 Pc/ Box	07945886029
L70QS	350	350	L70QS350	L70QS350.X	1 Pc/ Box	07945886030
L70QS	400	400	L70QS400	L70QS400.X	1 Pc/ Box	07945886031
L70QS	450	450	L70QS450	L70QS450.X	1 Pc/ Box	07945886032
L70QS	500	500	L70QS500	L70QS500.X	1 Pc/ Box	07945886033
L70QS	600	600	L70QS600	L70QS600.X	1 Pc/ Box	07945886034
L70QS	700	700	L70QS700	L70QS700.X	1 Pc/ Box	07945886035
L70QS	800	800	L70QS800	L70QS800.X	1 Pc/ Box	07945886036

L70QS SERIES HIGH-SPEED ROUND BODY FUSES

Dimensions Millimeters [inches]

Document Number: OL-L70QS000

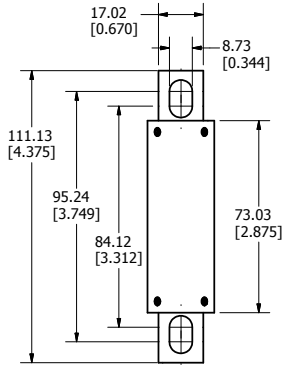

35-100A

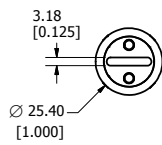

Stud Size: M8 (5/16")
Recommended Torque: 15 Nm (132.76 in-lb)

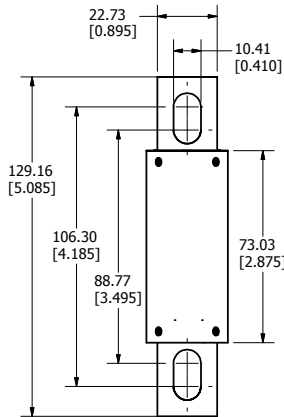

125-200A

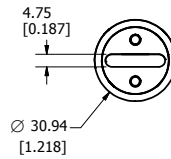

Stud Size: M8 (5/16")
Recommended Torque: 15 Nm (132.76 in-lb)

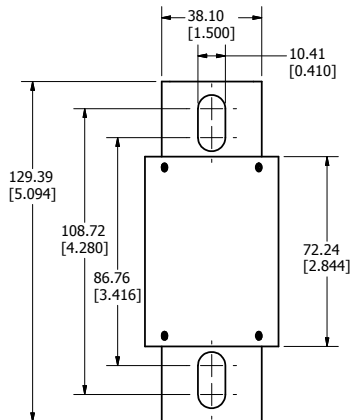

225-400A

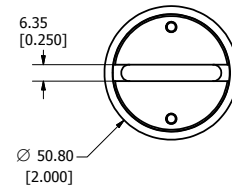

Stud Size: M8 (5/16")
Recommended Torque: 15 Nm (132.76 in-lb)

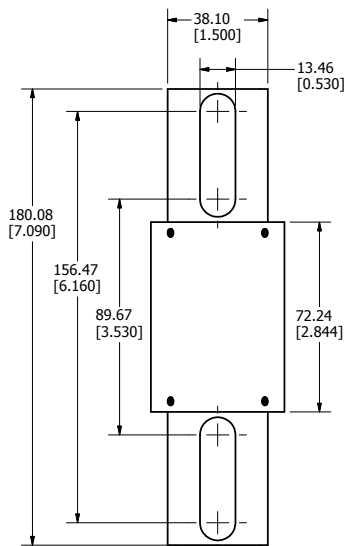

450-600A

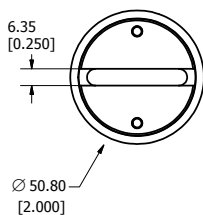

Stud Size: M12 (1/2")
Recommended Torque: 54 Nm (477.94 in-lb)

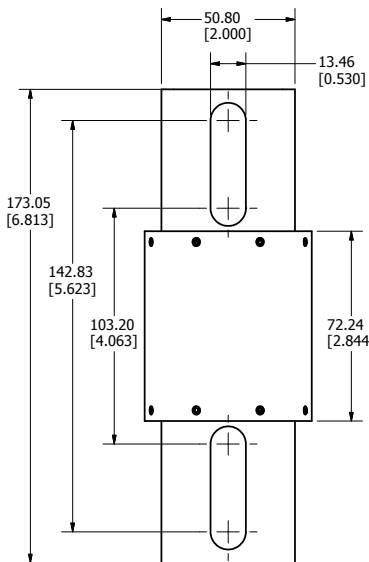

700-800A

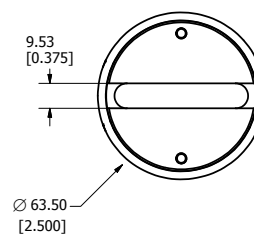

Stud Size: M12 (1/2")
Recommended Torque: 54 Nm (477.94 in-lb)

L70QS SERIES HIGH-SPEED ROUND BODY FUSES

Time Current Curve L70QS Series

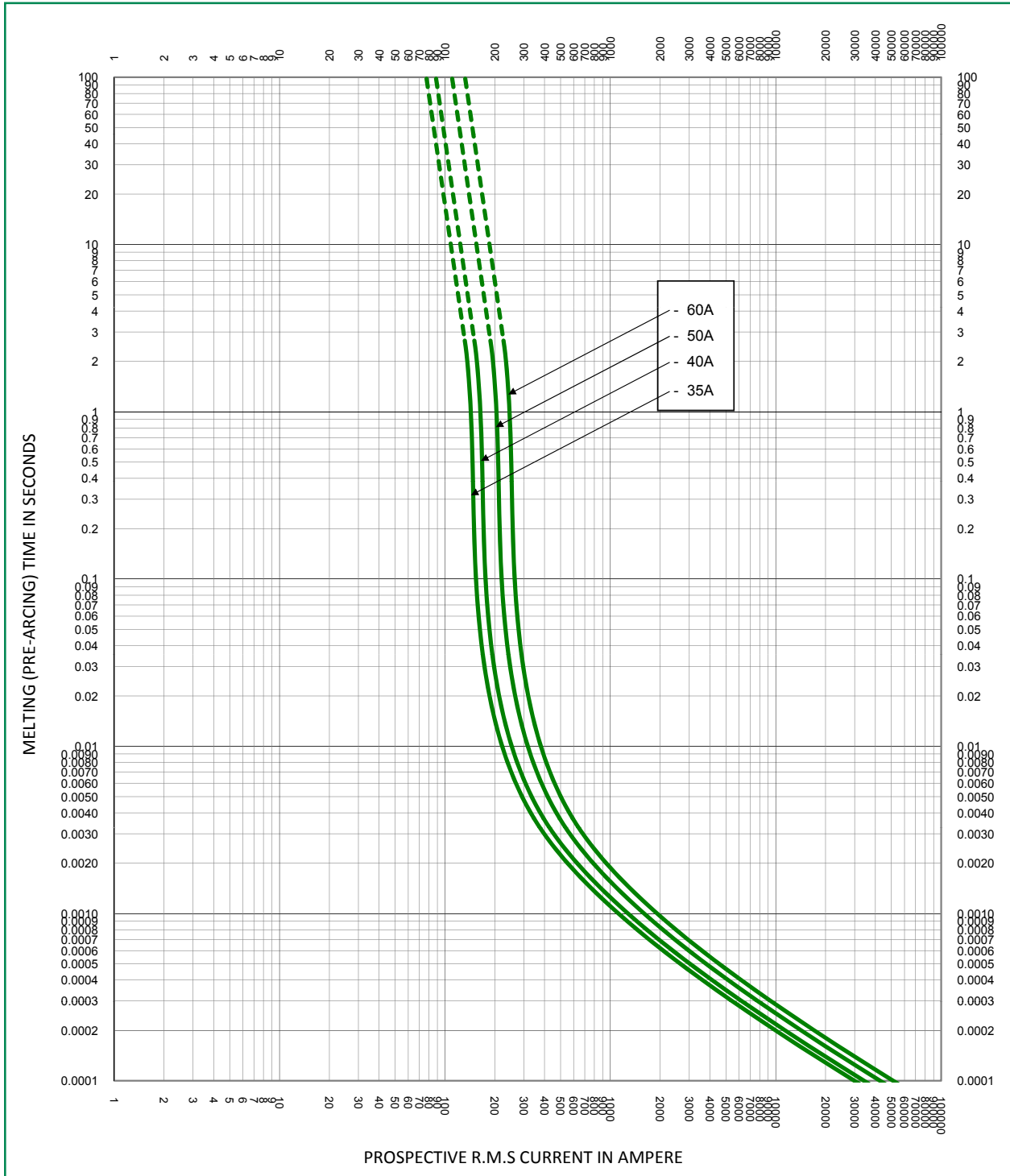

L70QS SERIES HIGH-SPEED ROUND BODY FUSES

Time Current Curve L70QS Series

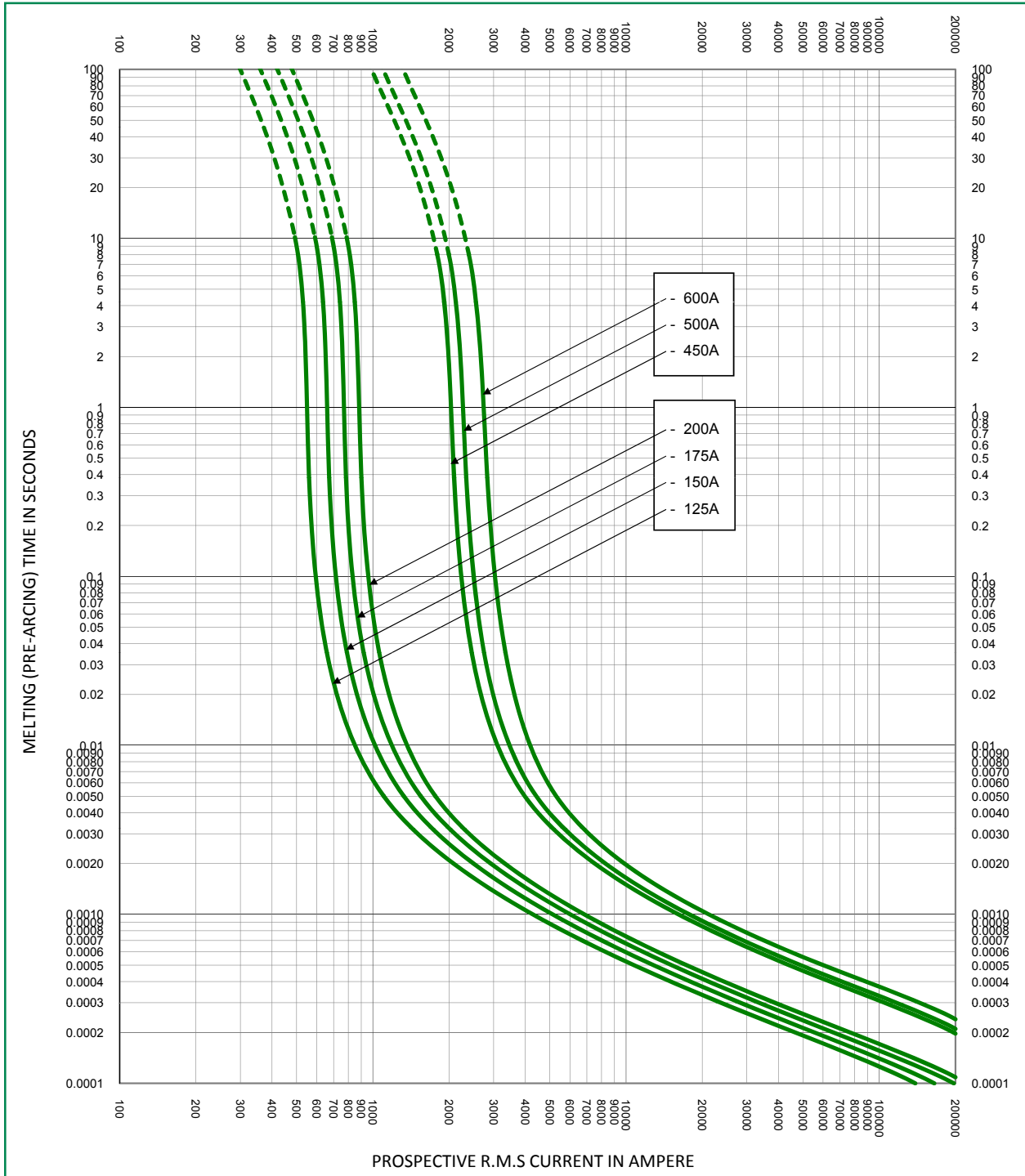

L70QS SERIES HIGH-SPEED ROUND BODY FUSES

Time Current Curve L70QS Series

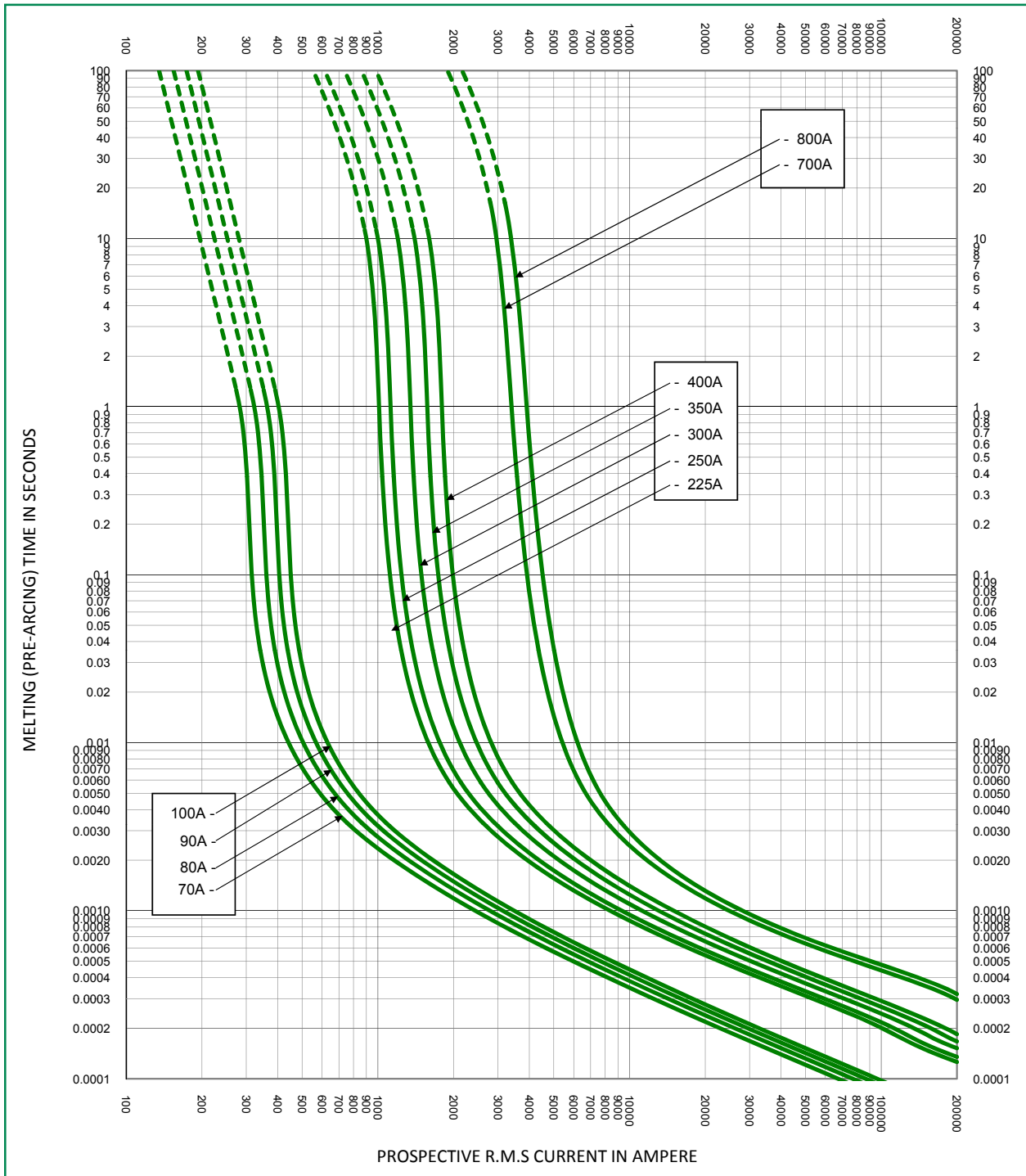

L70QS SERIES HIGH-SPEED ROUND BODY FUSES

Peak Let-Through Curve L70QS Series

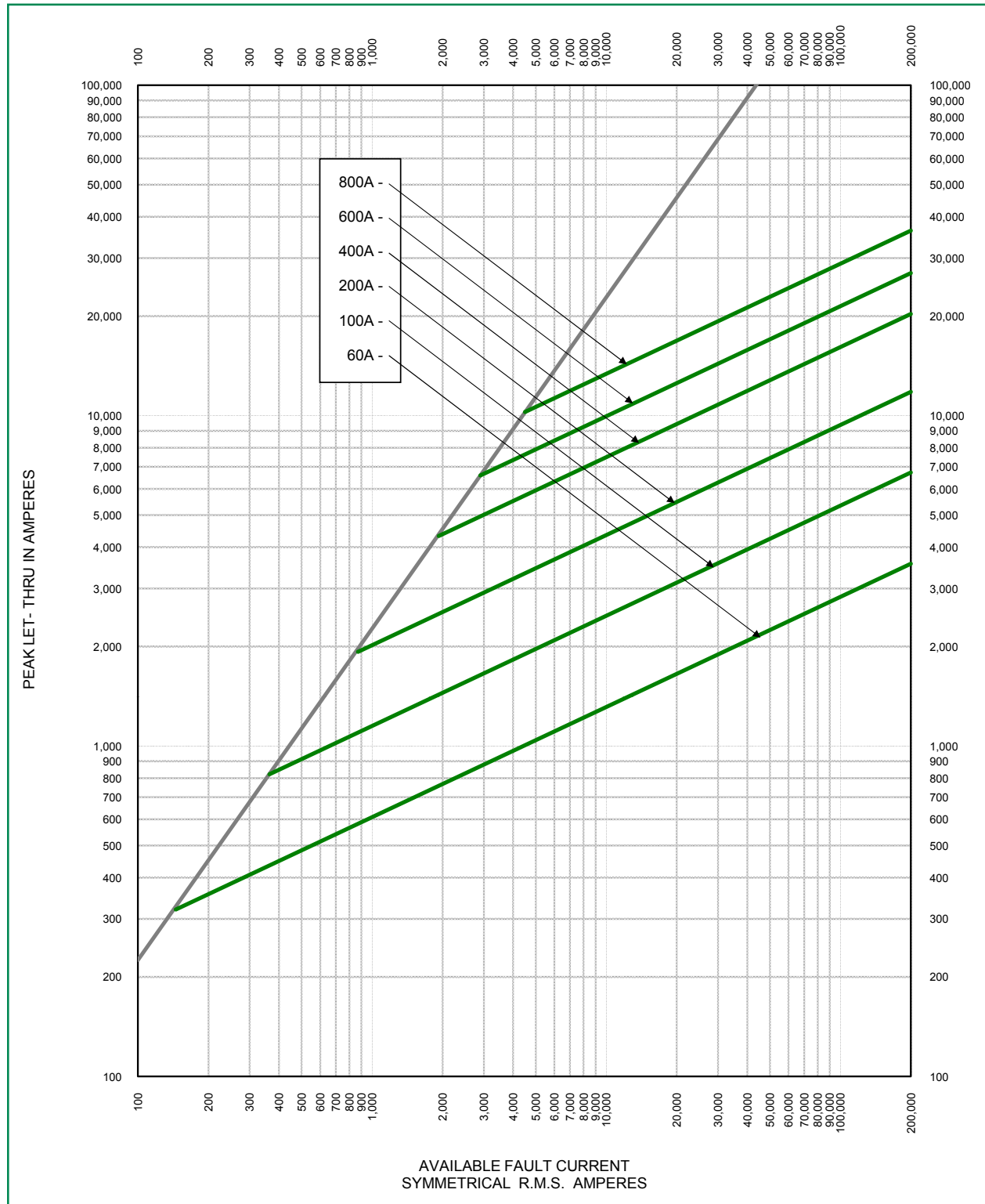

L70QS SERIES HIGH-SPEED ROUND BODY FUSES

Temperature De-rating Curve (Temperature of Air Immediately Surrounding Fuse)
L70QS Series

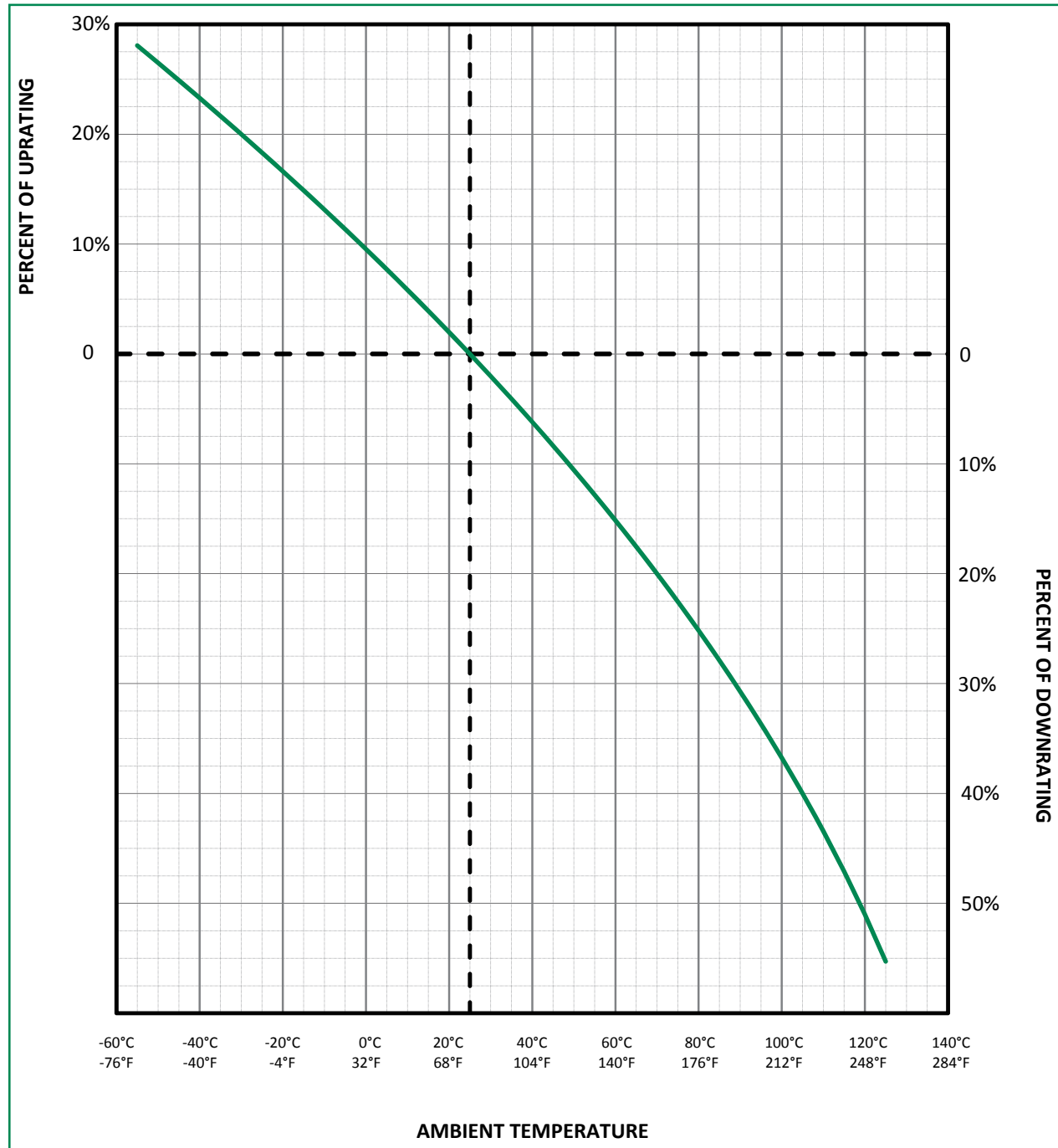

L70QS SERIES HIGH-SPEED ROUND BODY FUSES

Total Clearing I²t Correction Factor Curve

L70QS Series

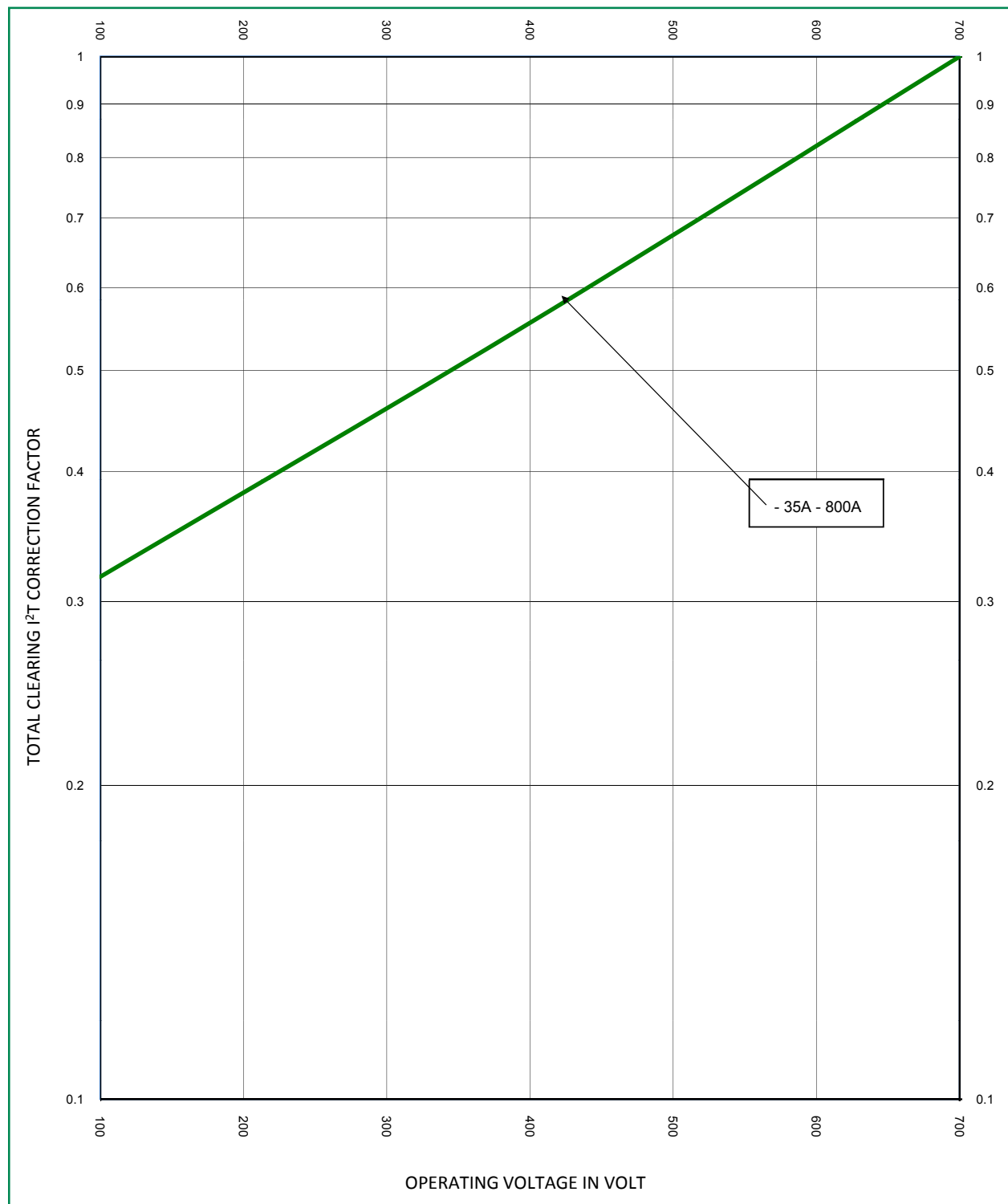

L70QS SERIES HIGH-SPEED ROUND BODY FUSES

Watts Loss Correction Factor Curve

L70QS Series

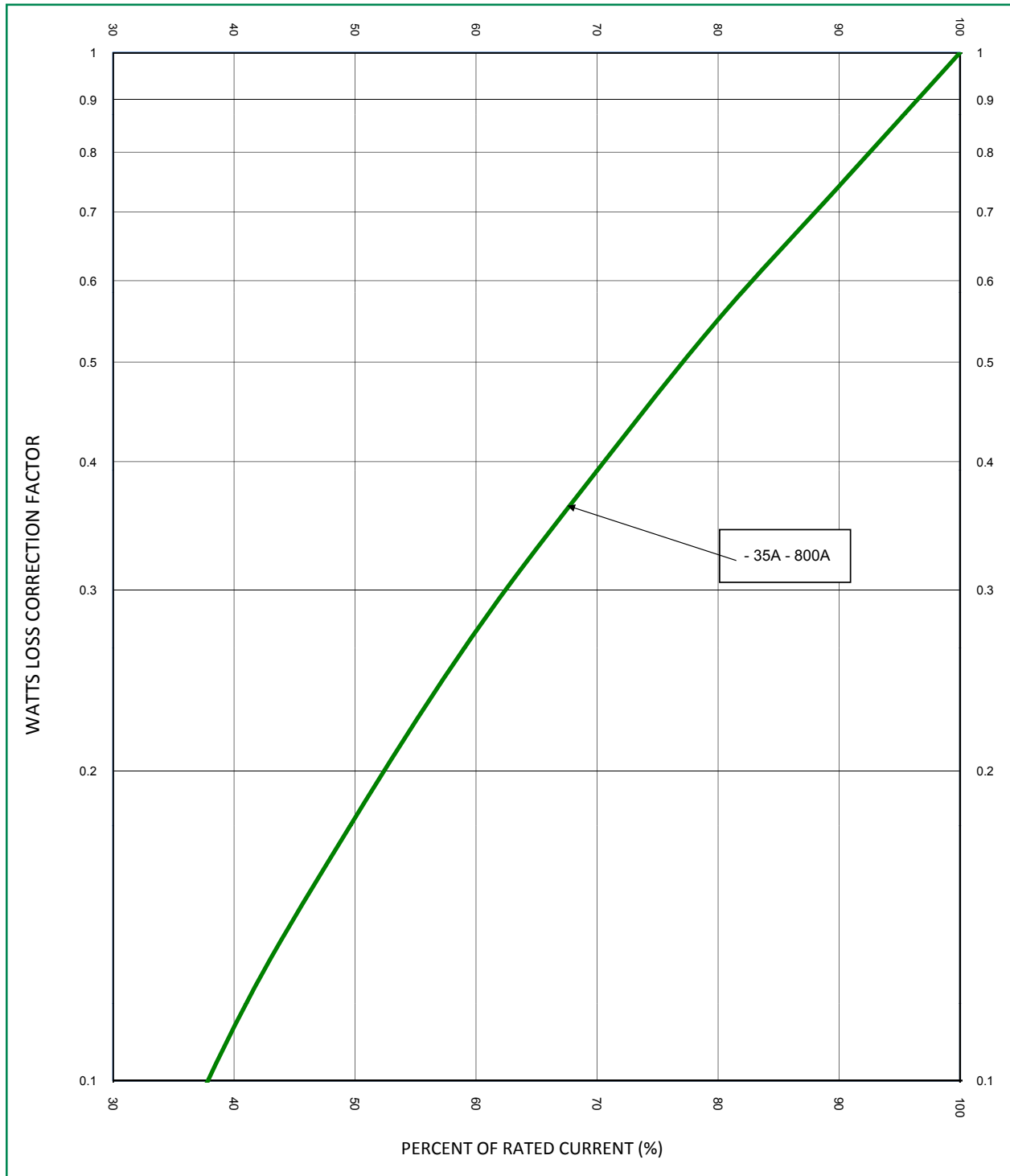

L70QS SERIES HIGH-SPEED ROUND BODY FUSES

Peak Arc Voltage Curve

L70QS Series

