

# FITTINGS

Finish: Painted Green or Electro-galvanized Order By: No., Size and Finish

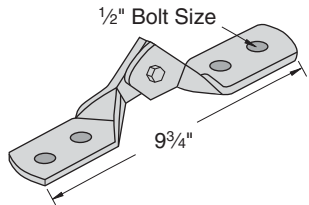

## PS 9404 – Four-Hole Hinge Connector



| Part No.     | Wt./100 pcs |
|--------------|-------------|
| PS 9404-1/2" | 126         |

## PS 692 – 1 5/8" Offset Zee Connector

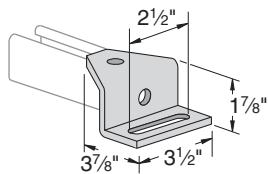

Weight/100 pcs: 102 lbs.

## PS 2523 – Offset Adjustable Zee Connector

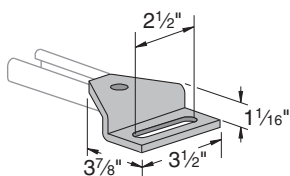

Use With: PS 500, PS 520, & PS 560

Weight/100 pcs: 70 lbs.

## PS 2532 – Shelf Attachment Zee

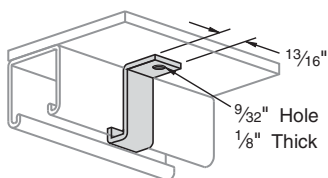

Stock Thickness: 1/8"

Use With: PS 200, PS 210

Weight/100 pcs: 9 lbs.

## PS 9403 – Three-Hole Hinge Connector

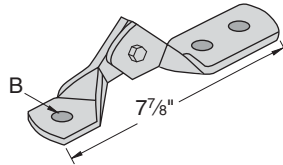

| "B" Bolt Size | Wt./100 pcs |
|---------------|-------------|
| 1/2"          | 108         |
| 5/8"          | 107         |
| 3/4"          | 106         |

Hinge Connect or Auto-Alignment Guides -

The unique edges of the two hinges have been designed to provide an alignment guide for 0°, 45° and 90° as shown in the drawings below.

This eliminates the need for measuring gages.

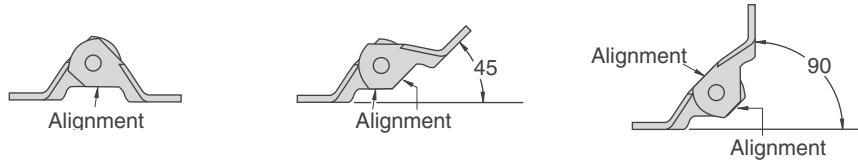

- Each half of the hinge is formed and welded for maximum strength.
- Hinged with Grade 5 bolt for superior strength.
- The nylon insert locknut prevents loosening of the hinge.

## PS 812 – 45° Diagonal Tube Brace

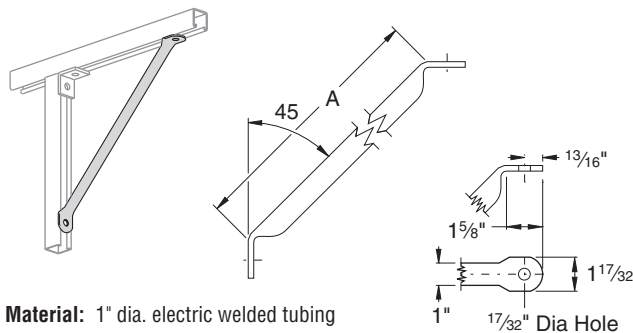

Material: 1" dia. electric welded tubing

Stock Thickness: (.075) 14 ga.

| A Size | Wt./100 pcs |
|--------|-------------|
| 12"    | 88          |
| 18"    | 116         |
| 24"    | 149         |
| 30"    | 181         |
| 36"    | 214         |

Design Load:  
Tension = 300 lbs.  
Comp. = 1,500 lbs.

## PS 3060 – Offset Connector

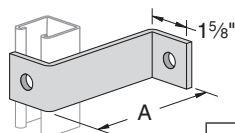

| A  | Wt./100 pcs |
|----|-------------|
| 4" | 81          |
| 5" | 92          |
| 6" | 104         |
| 7" | 115         |
| 8" | 127         |

## PS 647 – 1 7/8" Offset Zee Connector

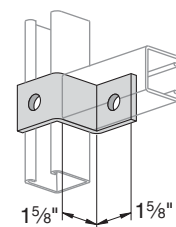

Use With: PS 200, PS 210

Weight/100 pcs: 55 lbs.