

ELECTROMAGNETIC FLUORESCENT BALLASTS

Supply Voltage and Frequency

Each ballast is designed to operate at the nominal voltage shown on the Philips Advance ballast label. Abnormal deviation from these values will result in damage to either the ballast or lamp or both. It is therefore necessary that the voltage applied to ballasts be maintained within the respective limits shown in the adjoining table.

A ballast subjected to higher than nominal voltages will typically operate at increased temperatures. This will result in reduced ballast life. Low voltage can cause premature lamp failures as well as unreliable lamp starting.

All ballasts are designed for single frequency operation. Therefore, best results will be obtained when that ballast is used on the frequency shown on the ballast label. Frequency limitations are as follows:

Nominal	Frequency Limits
60HZ	57.5 to 62.5
50HZ	47.5 to 52.5

Prefix Code Letters	Normal Voltage	Applied Voltage Limits	Color Label Identification
H	120	112-127	Yellow
R	120	112-127	Yellow
L	120	112-127	Yellow
S	120	112-127	Yellow
X	220	210-230	Green
M	220/250	210-230 / 235-260	—
Y	240	225-250	Orange
V	277	255-290	Red
G	347	322-365	Gray

Safety

The National Electrical Code requires grounding of fluorescent fixtures. The fluorescent ballast case must be grounded either to the fluorescent fixture or, if remote mounted, by other means such as a wire from the ballast case to ground. Without proper fixture and ballast grounding, a shock hazard may exist due to the fluorescent fixture becoming energized by an internal ballast failure to case. Also, all ballasts have normal leakage current. When the ballast is properly grounded, the leakage current should not pose a problem.

Ballast Date Codes

Philips Advance electromagnetic fluorescent lamp ballasts are date stamped on the ballast cover to designate month and year of manufacture. The month is indicated first, followed by the year. In the example shown 0100, the manufacturing date is January, 2000. In 2006 a new date stamp was implemented. The year is indicated first, followed by the calendar day of year and closes with an internal number (06 300 ###). For warranty information go to www.philips.com/advancewarranty.

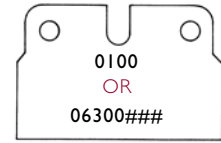

Indicates ballast is listed with Underwriters Laboratories, Inc. and complies with UL935 Standard for Fluorescent -Lamp Ballasts (File No. E14927).



Indicates ballast is component recognized with UL and complies with UL935 Standard for Fluorescent Lamp Ballasts (File No. E14927).

Visit www.ul.com to find a current listing of Philips Advance ballasts under File No. E14927.



Indicates ballast is certified by Canadian Standards Association and complies with CSA-22.2 File No. 74 for Fluorescent-Lamp Ballasts (File No. 007310).

Visit www.csa-international.org to find a current listing of Philips Advance ballasts under File No. 007310



Indicates ballast complies with U.S. Energy Standards.



Indicates ballast complies with Canadian Energy Standards.



Philips Advance fluorescent ballasts are designed and manufactured in accordance with the American National Standards Institute standard for fluorescent ballasts, ANSI C82.1.

Starting

The metal of a fluorescent fixture is a starting aid when properly grounded. T12 fluorescent lamps rated at 40W or less used for rapid or trigger start operation must be mounted within 1/2" of a grounded metal surface. T8 lamps must be mounted within 3/4" of a grounded metal surface. All other lamps must be mounted within 1" of a grounded metal surface.

An important additional factor for proper lamps starting is polarity. The white ballast lead must be connected to the ground of the power supply (neutral) and the black lead to the hot line wire. A reversal of polarity may result in lamp damage or improper lamp starting.

ELECTROMAGNETIC FLUORESCENT BALLASTS

Ballast Sound

The slight hum present in fluorescent lighting installations originates from the inherent magnetic action in the core & coil assembly of the ballasts. This hum may be amplified by the method of mounting the ballast in the fixture...the fixture design...and, more often than not, this hum is amplified by the resonant qualities of the ceiling, walls, floors and furniture. In planning a lighting installation, careful consideration must be given to the selection of the fluorescent lamp ballast, the lighting fixture and room components. These precautions will help to achieve the quietest installation possible.

The choice of fluorescent lamp ballast should be made on the basis of selecting the one rated quietest for a specific location or interior as some ballast have a more discernable hum due to basic construction features and electrical ratings.

Sound Ratings

For Any Installation in:	Average Ambient Noise Level Of Interior	Sound Level Rating*
TV or Radio Station, Library, Reception or Reading Room, Church, School Study Hall	20-24 Decibels	A
Residence, Quiet Office, Night School Classroom	25-30 Decibels	B
General Office Area, Commercial Building, Storeroom	31-36 Decibels	C
Manufacturing Facility, Retail Store, Noisy Office	37-42 Decibels	D

*These sound ratings are based on measurements of Average Ambient noise levels during conditions of normal occupancy. Audible ballast hum may appear amplified during exceptionally quiet periods and at times when area is unoccupied.

Radio Interference Filter



Radio interference is caused by the action of the arc at the lamp electrodes which creates a series of radio waves. This energy may interfere with radio reception by:

1. Direct radiation from the fluorescent lamp to the aerial circuit.
2. Line feedback from the lamp through the power line to the radio.
3. Direct radiation from the electrical supply line to the aerial circuit.

To correct the first cause, it is recommended the radio and aerial circuit be separated at least 10 feet from the fluorescent lamp and the radio provided with a positive ground.

The second and third causes can generally be corrected by the addition of an external capacitor-reactor filter. It is also desirable that the radio and fluorescent lamp fixture be provided a supply voltage from separate branch circuits.

SOUND RATED A

Input Volts	Catalog Number	Certifications		Line Current (Amps)	Dimensions (inches)				Wiring Diagram
					Length	Width	Height	Mounting	
120-277	RIF-1	✓	✓	4.25 max.	4 ³ / ₄	2 ⁷ / ₃₂	1 ⁵ / ₈	4 ³ / ₈	118

For bottom leads with studs, add suffix -BLS

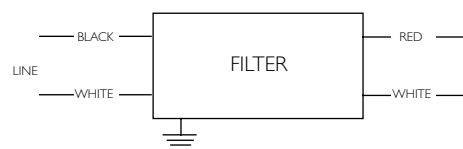

Diag. 118

Circline Lamps

NORMAL POWER FACTOR SOUND RATED A

Rapid Start Ballasts

Lamp Data		Min. Starting Temp. (F)	Input Volts	Catalog Number	Certifications				Line Current (Amps)	Input Power ANSI (Watts)	Ballast Factor	THD %	Power Factor	Dim.	Wiring Dia.
Number	Watts				UL	SF	E	IEC							
FC6T9 (20W Circline)															
1	20	50	120	RLQS-122-TP-W	✓	✓		0.56	24	0.76	<10	0.36	R-4	32	
FC8T9 (22W Circline)															
1	22	50	120	RLQS-122-TP-W	✓	✓		0.53	25	0.75	<10	0.39	R-4	32	
FC12T9 (32W Circline)															
1	32	50	120	RL-140-TP	✓	✓		0.59	32	0.68	<15	0.45	R-4	31	
				RLCS-140-TP-W	✓	✓		0.57	31	0.63	<10	0.45	R-4	32	
FC16T9 (40W Circline)															
1	40	50	120	RL-140-TP	✓	✓		0.46	29	0.55	<15	0.53	R-4	31	
				RLCS-140-TP-W	✓	✓		0.44	28	0.50	<15	0.53	R-4	32	
(1)FC8T9 & (1)FC12T9 ((1)22W & (1)32W Circline)															
2	22 & 32	50	120	RS-22-32-TP-W	✓	✓		0.40	46	0.70	<15	0.96	T-1	105	
(1)FC12T9 & (1)FC16T9 ((1)32W & (1)40W Circline)															
2	32 & 40	50	120	RS-32-40-TP-W	✓	✓		0.76	56	0.60	<20	0.61	T-1	105	

+ Mounting dimensions refer to slots only
Note: All Ballasts supplied with Circline sockets in white can except RL-140-TP

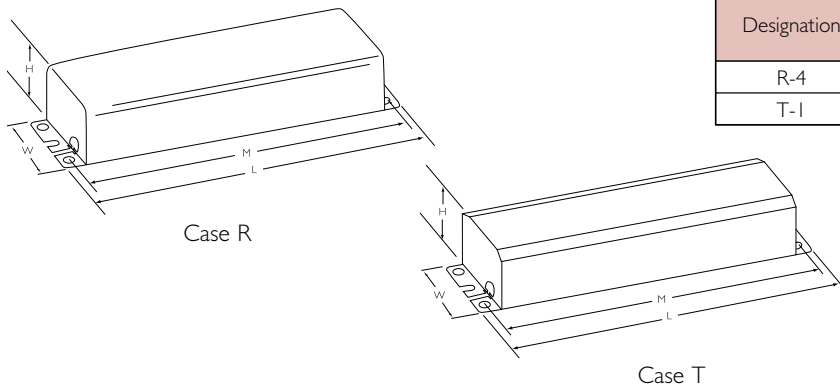

DIMENSIONS

Designation	Length (L) (inches)	Width (W) (inches)	Height (H) (inches)	Mounting (M) (inches)
R-4	6½	1 ⁵ / ₁₆	1 ³ / ₈	6+
T-1	6½	2 ³ / ₈	1½	6+

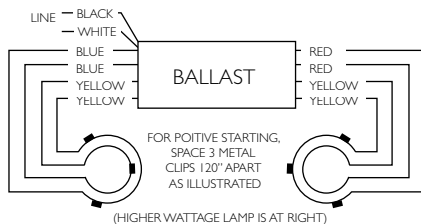

Diag. 105

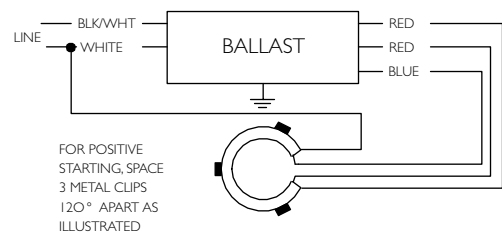

Diag. 31

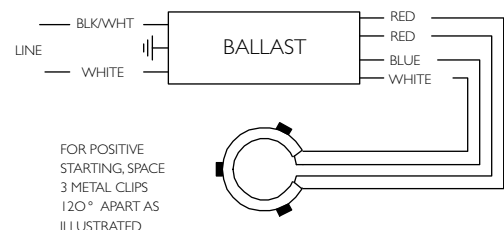

Diag. 32

Refer to pages 9-23 to 9-27 for lead lengths and shipping data