

SCHEDULE 40 AND SCHEDULE 80 ETL LISTED PVC RIGID NONMETALLIC CONDUIT AND ELBOWS



Schedule 40 Standard Radius

Schedule 40 Special Radius

Schedule 80 Standard Radius

Schedule 80 Special Radius

Schedule 40 Conduit

Schedule 80 Conduit



Prime Conduit® manufactures the most complete line of nonmetallic conduits in the electrical industry. Prime Conduit Schedule 40 and Schedule 80 conduits are designed for use aboveground and underground as described in the National Electrical Code. Specify only Prime Conduit conduits to insure raceway system quality.

Features

- **Ease of Installation** Nonmetallic conduits are $\frac{1}{4}$ to $\frac{1}{5}$ the weight of metallic systems, can be installed in less than half the time, and are easily fabricated on the job.
- **Safety** Nonmetallic conduits are nonconductive, assuring a safe system.
- **Impact Resistant** Prime Conduit Schedule 40 and Schedule 80 nonmetallic conduits are resistant to sunlight and are listed for exposed or outdoor usage.
- **Corrosion Resistant** Prime Conduit conduits are nonmetallic and will not rust or corrode.
- **Standards** Prime Conduit nonmetallic Schedule 40 and Schedule 80 conduit is manufactured to NEMA TC-2, Federal specification W-C-1094A and UL 651 specifications. The conduit carries respective ETL Listings and ETL labels.

Support of Prime Conduit Rigid Nonmetallic Conduit in Aboveground Installations

Table 352.30(B) NEC shows the support requirements for Schedule 40 and Schedule 80 rigid PVC nonmetallic conduit.

Plastic conduit should always be installed away from steam lines, etc. Support straps should allow for lineal movement caused by expansion and contraction.

Maximum ambient temperature is 122°F (50°C).

Table 352.30(B)

Conduit Trade Size	Maximum Spacing Between Supports (feet)
$\frac{1}{2}$ " - 1"	3
$1\frac{1}{4}$ " - 2"	5
$2\frac{1}{2}$ " - 3"	6
$3\frac{1}{2}$ " - 5"	7
6"	8

Acceptable Dimensions in Inches of Integral Bell per UL651.

Trade Size	A		B		C
	At Entrance (in.)		At Bottom (in.)		Nominal Bell Depth (in.)
	Maximum	Minimum	Maximum	Minimum	
$\frac{1}{2}$ "	0.860	0.844	0.844	0.828	1.875
$\frac{3}{4}$ "	1.074	1.054	1.056	1.036	2.125
1"	1.340	1.320	1.320	1.300	2.375
$1\frac{1}{4}$ "	1.689	1.665	1.667	1.643	2.625
$1\frac{1}{2}$ "	1.930	1.906	1.906	1.882	2.875
2"	2.405	2.381	2.381	2.357	3.500
$2\frac{1}{2}$ "	2.905	2.875	2.883	2.853	3.500
3"	3.530	3.500	3.507	3.477	4.375
$3\frac{1}{2}$ "	4.065	3.965	4.007	3.977	4.375
4"	4.565	4.465	4.506	4.476	4.875
5"	5.643	5.543	5.583	5.523	5.875
6"	6.708	6.608	6.644	6.584	6.500

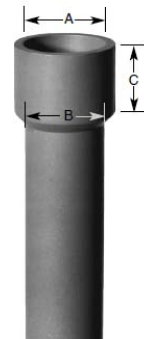

Schedule 40 PVC Rigid Nonmetallic Conduit

- ETL Listed to UL651 in compliance with the NEC
- Heavy Wall EPC
- Listed for underground applications encased in concrete or direct burial.
- Also for use in exposed or concealed applications aboveground.
- Sunlight resistant
- Rated for use with 90°C conductors
- Superior weathering characteristics
- Made in USA



Part Number		Trade Size	Std. Crate Qty.		Wt. Per 100'	Dimensions		
10'	20'		10'	20'		O.D.	I.D.	Wall
49005-010	-	1/2"	6000'	-	17	0.840	0.622	0.109
49007-010	49007-020	3/4"	4400'	8800'	23	1.050	0.824	0.113
49008-010	49008-020	1"	3600'	7200'	34	1.315	1.049	0.133
49009-010	49009-020	1 1/4"	3300'	6600'	46	1.660	1.380	0.140
49010-010	49010-020	1 1/2"	2250'	4500'	55	1.900	1.610	0.145
49011-010	49011-020	2"	1400'	2800'	73	2.375	2.067	0.154
49012-010	49012-020	2 1/2"	930'	1860'	124	2.875	2.469	0.203
49013-010	49013-020	3"	880'	1760'	163	3.500	3.068	0.216
49014-010	49014-020	3 1/2"	630'	1260'	196	4.000	3.548	0.226
49015-010	49015-020	4"	570'	1140'	232	4.500	4.026	0.237
49016-010	49016-020	5"	380'	760'	315	5.563	5.047	0.258
49017-010	49017-020	6"	260'	520'	409	6.625	6.065	0.280

*With Integral Bell



Notes:

1. Rigid nonmetallic conduit is normally supplied in standard 10' lengths, with one belled end per length. For specific requirements, it may be produced in lengths shorter or longer than 10', with or without belled ends
2. Special conduit sizes will be quoted on request.
3. DON'T FORGET TO ORDER CEMENT.
4. Use RNC Fittings with Schedule 40 and Schedule 80 Conduit
5. Prime Conduit reserves the right to ship to the nearest unitized quantity.

Schedule 80 PVC Rigid Nonmetallic Conduit

- ETL Listed to UL651 in compliance to the NEC
- Extra Heavy Wall EPC-80
- Listed for use in aboveground and belowground applications including areas subject to physical damage.
- Sunlight resistant
- Rated for use with 90°C conductors
- Superior weathering characteristics
- Identified for use in areas subject to physical damage in accordance to 352.12(C)
- Made in the USA



Part Number		Trade	Std. Crate Qty.		Wt. Per	Dimensions		
10'	20'	Size	10'	20'	100'	O.D.	I.D.	Wall
49405-010	49405-020	1/2"	6000'	12000'	21	0.840	0.546	0.147
49407-010	49407-020	3/4"	4400'	8000'	30	1.050	0.742	0.154
49408-010	49408-020	1"	3600'	7200'	44	1.315	0.957	0.179
49409-010	49409-020	1 1/4"	3300'	6600'	60	1.660	1.278	0.191
49410-010	49410-020	1 1/2"	2250'	3600'	72	1.900	1.500	0.200
49411-010	49411-020	2"	1400'	2800'	101	2.375	1.939	0.218
49412-010	49412-020	2 1/2"	930'	1880'	154	2.875	2.323	0.276
49413-010	49413-020	3"	880'	1760'	210	3.500	2.900	0.300
49415-010	49415-020	4"	570'	1140'	308	4.500	3.826	0.337
49416-010	—	5"	380'	—	428	5.563	4.813	0.375
49417-010	49417-020	6"	260'	520'	588	6.625	5.761	0.432

*With Integral Bell



Notes:

1. Rigid nonmetallic conduit is normally supplied in standard 10' lengths, with one belled end per length. For specific requirements, it may be produced in lengths shorter or longer than 10', with or without belled ends
2. Special conduit sizes will be quoted on request.
3. DON'T FORGET TO ORDER CEMENT.
4. Use RNC Fittings with Schedule 40 and 80 Conduit
5. Prime Conduit reserves the right to ship to the nearest unitized quantity.

Prime Conduit PVC Elbows and Sweeps Part Numbering System

Prime Conduit Elbows and Sweeps Part Numbering System					
Position:	1	2	3	4	5
Letter/Number:	UA	7	A	K	
Description:	Sch. 40	45°	Std. Radius	2 ½"	Non-Belled

1: Product Line

- UA = Schedule 40 Heavy Wall EPC
- UB = Schedule 80 Extra Heavy Wall EPC
- UC = Schedule 40 Heavy Wall Utility Conduit*
- PE = DB-100 Sweeps*
- PF = DB-60 Sweeps*
- PH = DB-120 Sweeps*
- TP = Telephone Duct "C" Sweeps*
- TW = White Telephone Duct "C" Sweeps*



* Non-ETL Listed

2: Angle

- 9 = 90° Elbow
- 7 = 45° Elbow
- 6 = 30° Elbow
- 5 = 22 ½° Elbow
- 3 = 11 ¼° Elbow

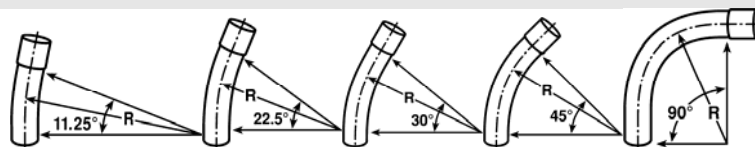

3: Radius

- A = Standard Radius
- B = 12"
- C = 18"
- D = 24"
- E = 30"
- F = 36"
- H = 48"
- I = 60"
- J = 72"
- N = 120"
- R = 144"
- S = 150"
- T = 180"
- U = 240"
- V = 300"

4: Diameter

- | | |
|----------|----------|
| D = ½" | L = 3" |
| E = ¾" | M = 3 ½" |
| F = 1" | N = 4" |
| G = 1 ¼" | P = 5" |
| H = 1 ½" | R = 6" |
| J = 2" | T = 8" |
| K = 2 ½" | |



5: Belled Elbow

- B = Belled; All DB-100, DB-60, DB-120, and Telephone Duct sweeps are belled and do not have the "B" in position 5.
- S = Segmented



Schedule 40 and 80 PVC Rigid Nonmetallic Elbows

Sales Information:

- ETL Listed to UL 651 in compliance with the NEC.
- Meets NEMA TC3 - *Polyvinyl Chloride (PVC) Fittings for Use with Rigid PVC Conduit and Tubing.*
- Not all configurations are stocked.
- Elbows 72" and larger may be shipped in segments.
- Contact your local Rep for more information.
- Consult factory for additional sizes/configurations.

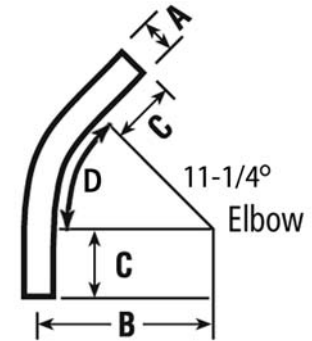

Dimensional Information:

- Dimensions are nominal.
- Average outer diameter per UL651, Table 4.1
- Minimum standard radius per UL 651, Table 4.10
- Minimum tangent length per UL651, Table 4.10

Trade Size	Average OD "A"	Min. Standard Radius "B"	Special Radius "B"	Min. Tangent Length "C"	Arc Length "D"
1/2"	0.840"	4"	See part number list on the special radius elbow pages.	1 1/2"	*See calculation below.
3/4"	1.050"	4 1/2"		1 1/2"	
1"	1.315"	5 3/4"		1 7/8"	
1 1/4"	1.660"	7 1/4"		2"	
1 1/2"	1.900"	8 1/4"		2"	
2"	2.375"	9 1/2"		2"	
2 1/2"	2.875"	10 1/2"		3"	
3"	3.500"	13"		3 1/8"	
3 1/2"	4.000"	15"		3 1/4"	
4"	4.500"	16"		3 3/8"	
5"	5.563"	24"		3 5/8"	
6"	6.625"	30"		3 3/4"	

*Arc Length "D" = $[2 * \text{Radius}] * \pi * [\text{Angle}/360]$

Example: Arc Length_{UA3AD} = $[2 * 4] * 3.14 * [11.25/360] = 0.79"$

Schedule 40 and 80 Integral Belled End Dimensions for Elbows (Per UL651, Table 4.4):

Trade Size	A		B		C
	At Entrance (in.)		At Bottom (in.)		Minimum Bell Depth (in.)
	Maximum	Minimum	Maximum	Minimum	
1/2"	0.860	0.844	0.844	0.828	0.652
3/4"	1.074	1.054	1.056	1.036	0.719
1"	1.340	1.320	1.320	1.300	0.875
1 1/4"	1.689	1.665	1.667	1.643	0.938
1 1/2"	1.930	1.906	1.906	1.882	1.062
2"	2.405	2.381	2.381	2.357	1.125
2 1/2"	2.905	2.875	2.883	2.853	1.469
3"	3.530	3.500	3.507	3.477	1.594
3 1/2"	4.065	3.965	4.007	3.977	1.687
4"	4.565	4.465	4.506	4.476	1.750
5"	5.643	5.543	5.583	5.523	1.937
6"	6.708	6.608	6.644	6.584	2.125

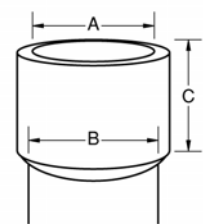

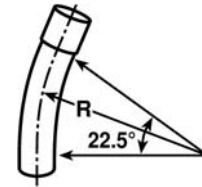
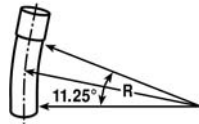

Part Number	Trade Size	Type	Carton Quantity	EACH UPC
UA3AD	1/2"	PLAIN END	50	670648079838
UA3AE	3/4"	PLAIN END	25	670648079845
UA3AF	1"	PLAIN END	25	670648079920
UA3AG	1-1/4"	PLAIN END	20	670648079937
UA3AH	1-1/2"	PLAIN END	25	670648337716
UA3AJ	2"	PLAIN END	20	670648337730
UA3AK	2-1/2"	PLAIN END	10	670648337754
UA3AL	3"	PLAIN END	25	670648337761
UA3AM	3-1/2"	PLAIN END	16	670648079944
UA3AN	4"	PLAIN END	16	670648224481
UA3ANB	4"	BELL END	16	670648224498
UA3AP	5"	PLAIN END	1	670648337778
UA3AR	6"	PLAIN END	1	670648224511

Part Number	Trade Size	Type	Carton Quantity	EACH UPC
UA5AD	1/2"	PLAIN END	50	670648079913
UA5AE	3/4"	PLAIN END	25	670648225204
UA5AF	1"	PLAIN END	20	670648225211
UA5AG	1-1/4"	PLAIN END	25	670648338331
UA5AH	1-1/2"	PLAIN END	20	670648225242
UA5AJ	2"	PLAIN END	25	670648225266
UA5AJB	2"	BELL END	25	670648225273
UA5AK	2-1/2"	PLAIN END	20	670648225280
UA5AL	3"	PLAIN END	20	670648225303
UA5ALB	3"	BELL END	12	670648225310
UA5AM	3-1/2"	PLAIN END	8	670648338355
UA5AN	4"	PLAIN END	12	670648225334
UA5ANB	4"	BELL END	12	670648225341
UA5AP	5"	PLAIN END	1	670648225358
UA5APB	5"	BELL END	1	670648079616
UA5AR	6"	PLAIN END	1	670648225372
UA5ARB	6"	BELL END	1	670648225389

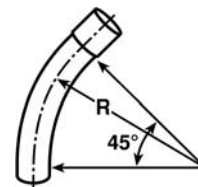
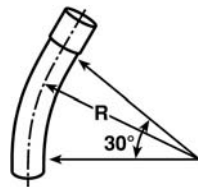

Part Number	Trade Size	Type	Carton Quantity	EACH UPC
UA6AD	1/2"	PLAIN END	50	670648060812
UA6ADB	1/2"	BELL END	50	670648054538
UA6AE	3/4"	PLAIN END	25	670648060829
UA6AEB	3/4"	BELL END	25	670648054545
UA6AF	1"	PLAIN END	20	670648060836
UA6AFB	1"	BELL END	20	670648054569
UA6AG	1-1/4"	PLAIN END	25	670648060843
UA6AGB	1-1/4"	BELL END	20	670648196382
UA6AH	1-1/2"	PLAIN END	50	670648060850
UA6AHB	1-1/2"	BELL END	25	670648196399
UA6AJ	2"	PLAIN END	20	670648060867
UA6AJB	2"	BELL END	20	670648196405
UA6AK	2-1/2"	PLAIN END	20	670648060874
UA6AKB	2-1/2"	BELL END	20	670648196412
UA6AL	3"	PLAIN END	18	670648060881
UA6ALB	3"	BELL END	18	670648196429
UA6AM	3-1/2"	PLAIN END	12	670648060898
UA6AMB	3-1/2"	BELL END	10	670648196436
UA6AN	4"	PLAIN END	10	670648060904
UA6ANB	4"	BELL END	10	670648196443
UA6AP	5"	PLAIN END	1	670648060928
UA6APB	5"	BELL END	1	670648196450
UA6AR	6"	PLAIN END	1	670648060942
UA6ARB	6"	BELL END	1	670648196467

Part Number	Trade Size	Type	Carton Quantity	EACH UPC
UA7AD	1/2"	PLAIN END	50	670648060614
UA7ADB	1/2"	BELL END	50	670648039009
UA7AE	3/4"	PLAIN END	25	670648060621
UA7AEB	3/4"	BELL END	25	670648039016
UA7AF	1"	PLAIN END	20	670648060638
UA7AFB	1"	BELL END	20	670648039023
UA7AG	1-1/4"	PLAIN END	25	670648060645
UA7AGB	1-1/4"	BELL END	25	670648196290
UA7AH	1-1/2"	PLAIN END	20	670648060652
UA7AHB	1-1/2"	BELL END	30	670648196306
UA7AJ	2"	PLAIN END	20	670648060669
UA7AJB	2"	BELL END	20	670648196320
UA7AK	2-1/2"	PLAIN END	20	670648226102
UA7AKB	2-1/2"	BELL END	20	670648226119
UA7AL	3"	PLAIN END	1	670648060683
UA7ALB	3"	BELL END	12	670648196337
UA7AM	3-1/2"	PLAIN END	1	670648060690
UA7AMB	3-1/2"	BELL END	1	670648196344
UA7AN	4"	PLAIN END	1	670648060607
UA7ANB	4"	BELL END	1	670648196351
UA7AP	5"	PLAIN END	1	670648060720
UA7APB	5"	BELL END	1	670648196368
UA7AR	6"	PLAIN END	1	670648060744
UA7ARB	6"	BELL END	1	670648196375

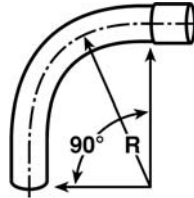

Part Number	Trade Size	Type	Carton Quantity	EACH UPC
UA9AD	1/2"	PLAIN END	50	670648060416
UA9ADB	1/2"	BELL END	50	670648226980
UA9AE	3/4"	PLAIN END	35	670648060423
UA9AEB	3/4"	BELL END	35	670648227017
UA9AF	1"	PLAIN END	20	670648060430
UA9AFB	1"	BELL END	20	670648227048
UA9AG	1-1/4"	PLAIN END	30	670648060447
UA9AGB	1-1/4"	BELL END	30	670648196207
UA9AH	1-1/2"	PLAIN END	30	670648060454
UA9AHB	1-1/2"	BELL END	30	670648196214
UA9AJ	2"	PLAIN END	20	670648060461
UA9AJB	2"	BELL END	20	670648196221
UA9AK	2-1/2"	PLAIN END	10	670648060478
UA9AKB	2-1/2"	BELL END	10	670648196238
UA9AL	3"	PLAIN END	1	670648060485
UA9ALB	3"	BELL END	1	670648196245
UA9AM	3-1/2"	PLAIN END	1	670648060492
UA9AMB	3-1/2"	BELL END	1	670648196252
UA9AN	4"	PLAIN END	1	670648060508
UA9ANB	4"	BELL END	1	670648196269
UA9AP	5"	PLAIN END	1	670648060522
UA9APB	5"	BELL END	1	670648196276
UA9AR	6"	PLAIN END	1	670648060546
UA9ARB	6"	BELL END	1	670648196283

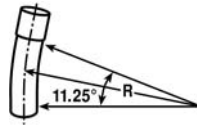

Part Number	Trade Size	Type	Radius "B"	EACH UPC
UA3DJ	2"	PLAIN END	24"	670648224535
UA3DJB	2"	BELL END	24"	670648080766
UA3FJ	2"	PLAIN END	36"	670648337860
UA3FJB	2"	BELL END	36"	670648081053
UA3HJ	2"	PLAIN END	48"	670648081183
UA3HK	2-1/2"	PLAIN END	48"	670648081206
UA3DL	3"	PLAIN END	24"	670648337822
UA3DLB	3"	BELL END	24"	670648080797
UA3FL	3"	PLAIN END	36"	670648337884
UA3FLB	3"	BELL END	36"	670648081084
UA3HL	3"	PLAIN END	48"	670648081220
UA3DM	3-1/2"	PLAIN END	24"	670648080803
UA3HM	3-1/2"	PLAIN END	48"	670648079869
UA3DN	4"	PLAIN END	24"	670648224542
UA3DNB	4"	BELL END	24"	670648080827
UA3FN	4"	PLAIN END	36"	670648224603
UA3FNB	4"	BELL END	36"	670648224610
UA3HN	4"	PLAIN END	48"	670648337938
UA3HNB	4"	BELL END	48"	670648079883
UA3RNB	4"	BELL END	144"	670648967180
UA3SNB	4"	BELL END	150"	670648338119
UA3TNB	4"	BELL END	180"	670648967197
UA3FP	5"	PLAIN END	36"	670648224634
UA3FPB	5"	BELL END	36"	670648081114
UA3HP	5"	PLAIN END	48"	670648145984
UA3RPB	5"	BELL END	144"	670648214819
UA3UPB	5"	BELL END	240"	670648184877
UA3FR	6"	PLAIN END	36"	670648224641
UA3FRB	6"	BELL END	36"	670648081121
UA3HR	6"	PLAIN END	48"	670648224689
UA3HRB	6"	BELL END	48"	670648967173
UA3JR	6"	PLAIN END	72"	670648141535
UA3NR	6"	PLAIN END	120"	670648141528
UA3RRB	6"	BELL END	144"	670648356229
UA3SRB	6"	BELL END	150"	670648126198
UA3TRB	6"	BELL END	180"	670648967203

Carton Quantity = 1

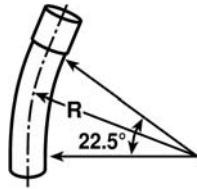

Part Number	Trade Size	Type	Radius "B"	EACH UPC
UA5FF	1"	PLAIN END	36"	670648054637
UA5FG	1-1/4"	PLAIN END	36"	670648054880
UA5FH	1-1/2"	PLAIN END	36"	670648054910
UA5FHB	1-1/2"	BELL END	36"	670648055672
UA5CJ	2"	PLAIN END	18"	670648068634
UA5CJB	2"	BELL END	18"	670648198003
UA5DJ	2"	PLAIN END	24"	670648068696
UA5DJB	2"	BELL END	24"	670648198058
UA5EJ	2"	PLAIN END	30"	670648338416
UA5EJB	2"	BELL END	30"	670648055696
UA5FJ	2"	PLAIN END	36"	670648068870
UA5FJB	2"	BELL END	36"	670648197822
UA5HJ	2"	PLAIN END	48"	670648054941
UA5HJB	2"	BELL END	48"	670648214871
UA5VJ	2"	PLAIN END	300"	670648111491
UA5CK	2-1/2"	PLAIN END	18"	670648068641
UA5DK	2-1/2"	PLAIN END	24"	670648068702
UA5DKB	2-1/2"	BELL END	24"	670648967210
UA5EK	2-1/2"	PLAIN END	30"	670648054958
UA5FK	2-1/2"	PLAIN END	36"	670648068887
UA5HK	2-1/2"	PLAIN END	48"	670648054965
UA5CLB	3"	BELL END	18"	670648198027
UA5DL	3"	PLAIN END	24"	670648068719
UA5DLB	3"	BELL END	24"	670648198072
UA5EL	3"	PLAIN END	30"	670648054972
UA5ELB	3"	BELL END	30"	670648004625
UA5FL	3"	PLAIN END	36"	670648068900
UA5FLB	3"	BELL END	36"	670648197846
UA5HL	3"	PLAIN END	48"	670648068894
UA5VL	3"	PLAIN END	300"	670648121063
UA5DM	3-1/2"	PLAIN END	24"	670648068726
UA5EM	3-1/2"	PLAIN END	30"	670648054989
UA5FM	3-1/2"	PLAIN END	36"	670648068917
UA5HM	3-1/2"	PLAIN END	48"	670648054996
UA5DN	4"	PLAIN END	24"	670648068733
UA5DNB	4"	BELL END	24"	670648197716
UA5EN	4"	PLAIN END	30"	670648068825
UA5ENB	4"	BELL END	30"	670648197785
UA5FN	4"	PLAIN END	36"	670648068924
UA5FNB	4"	BELL END	36"	670648197860
UA5HN	4"	PLAIN END	48"	670648069013
UA5HNB	4"	BELL END	48"	670648197952
UA5IN	4"	PLAIN END	60"	670648225556
UA5JN	4"	PLAIN END	72"	670648176087
UA5RNB	4"	BELL END	144"	670648214932
UA5SN	4"	PLAIN END	150"	670648225716
UA5SNB	4"	BELL END	150"	670648225723
UA5TNB	4"	BELL END	180"	670648967227
UA5UNB	4"	BELL END	240"	670648225815
UA5VNB	4"	BELL END	300"	670648225907

Part Number	Trade Size	Type	Radius "B"	EACH UPC
UA5DPB	5"	BELL END	24"	670648225440
UA5EP	5"	PLAIN END	30"	670648068832
UA5EPB	5"	BELL END	30"	670648197792
UA5FP	5"	PLAIN END	36"	670648068931
UA5FPB	5"	BELL END	36"	670648197877
UA5HP	5"	PLAIN END	48"	670648069044
UA5HPB	5"	BELL END	48"	670648197969
UA5IP	5"	PLAIN END	60"	670648338577
UA5RPB	5"	BELL END	144"	670648214925
UA5SP	5"	PLAIN END	150"	670648225754
UA5UPB	5"	BELL END	240"	670648140286
UA5VPB	5"	BELL END	300"	670648225921
UA5FR	6"	PLAIN END	36"	670648068948
UA5FRB	6"	BELL END	36"	670648197884
UA5HR	6"	PLAIN END	48"	670648069020
UA5HRB	6"	BELL END	48"	670648197976
UA5IR	6"	PLAIN END	60"	670648225587
UA5JR	6"	PLAIN END	72"	670648141573
UA5NR	6"	PLAIN END	120"	670648141566
UA5RR	6"	PLAIN END	144"	670648089646
UA5RRB	6"	BELL END	144"	670648000696
UA5SR	6"	PLAIN END	150"	670648120820
UA5TRB	6"	BELL END	180"	670648967234
UA5VR	6"	PLAIN END	300"	670648338737

Carton Quantity = 1

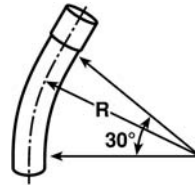

Part Number	Trade Size	Type	Radius "B"	EACH UPC
UA6CJ	2"	PLAIN END	18"	670648068207
UA6DJ	2"	PLAIN END	24"	670648067262
UA6DJB	2"	BELL END	24"	670648055320
UA6FJ	2"	PLAIN END	36"	670648068184
UA6FJB	2"	BELL END	36"	670648055351
UA6HJ	2"	PLAIN END	48"	670648068191
UA6HJB	2"	BELL END	48"	670648055368
UA6CK	2-1/2"	PLAIN END	18"	670648068214
UA6DK	2-1/2"	PLAIN END	24"	670648081367
UA6CL	3"	PLAIN END	18"	670648068221
UA6DL	3"	PLAIN END	24"	670648067767
UA6DLB	3"	BELL END	24"	670648197693
UA6FL	3"	PLAIN END	36"	670648068283
UA6FLB	3"	BELL END	36"	670648197440
UA6HL	3"	PLAIN END	48"	670648068290
UA6HLB	3"	BELL END	48"	670648197532
UA6DM	3-1/2"	PLAIN END	24"	670648054835
UA6FM	3-1/2"	PLAIN END	36"	670648054859
UA6HM	3-1/2"	PLAIN END	48"	670648054866
UA6DN	4"	PLAIN END	24"	670648067866
UA6FN	4"	PLAIN END	36"	670648068382
UA6FNB	4"	BELL END	36"	670648197464
UA6HN	4"	PLAIN END	48"	670648068399
UA6HNB	4"	BELL END	48"	670648197556
UA6IN	4"	PLAIN END	60"	670648967241
UA6INB	4"	BELL END	60"	670648967258
UA6FP	5"	PLAIN END	36"	670648068436
UA6FPB	5"	BELL END	36"	670648055573
UA6HP	5"	PLAIN END	48"	670648068443
UA6HPB	5"	BELL END	48"	670648197563
UA6VP	5"	PLAIN END	300"	670648142686
UA6FR	6"	PLAIN END	36"	670648068481
UA6FRB	6"	BELL END	36"	670648055580
UA6HR	6"	PLAIN END	48"	670648068498
UA6HRB	6"	BELL END	48"	670648055597

Carton Quantity =1

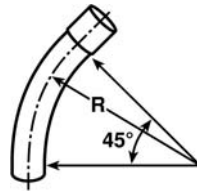

Part Number	Trade Size	Type	Radius "B"	EACH UPC
UA7CF	1"	PLAIN END	18"	670648067606
UA7DF	1"	PLAIN END	24"	670648067705
UA7EF	1"	PLAIN END	30"	670648054576
UA7FF	1"	PLAIN END	36"	670648067910
UA7HF	1"	PLAIN END	48"	670648054583
UA7CG	1-1/4"	PLAIN END	18"	670648067613
UA7DG	1-1/4"	PLAIN END	24"	670648067712
UA7EG	1-1/4"	PLAIN END	30"	670648054651
UA7FG	1-1/4"	PLAIN END	36"	670648067583
UA7HG	1-1/4"	PLAIN END	48"	670648067972
UA7CH	1-1/2"	PLAIN END	18"	670648067620
UA7DH	1-1/2"	PLAIN END	24"	670648067750
UA7EH	1-1/2"	PLAIN END	30"	670648054668
UA7FH	1-1/2"	PLAIN END	36"	670648067958
UA7FHB	1-1/2"	BELL END	36"	670648197112
UA7HH	1-1/2"	PLAIN END	48"	670648054675
UA7BJB	2"	BELL END	12"	670648174717
UA7CJ	2"	PLAIN END	18"	670648067637
UA7CJB	2"	BELL END	18"	670648196924
UA7DJ	2"	PLAIN END	24"	670648067668
UA7DJB	2"	BELL END	24"	670648196979
UA7EJ	2"	PLAIN END	30"	670648067675
UA7EJB	2"	BELL END	30"	670648197044
UA7FJ	2"	PLAIN END	36"	670648067682
UA7FJB	2"	BELL END	36"	670648197129
UA7HJ	2"	PLAIN END	48"	670648067699
UA7HJB	2"	BELL END	48"	670648226355
UA7SJ	2"	PLAIN END	150"	670648114560
UA7CK	2-1/2"	PLAIN END	18"	670648067651
UA7DK	2-1/2"	PLAIN END	24"	670648067811
UA7DKB	2-1/2"	BELL END	24"	670648196986
UA7EK	2-1/2"	PLAIN END	30"	670648054682
UA7FK	2-1/2"	PLAIN END	36"	670648067736
UA7FKB	2-1/2"	BELL END	36"	670648197136
UA7HK	2-1/2"	PLAIN END	48"	670648067743
UA7CL	3"	PLAIN END	18"	670648067644
UA7CLB	3"	BELL END	18"	670648196948
UA7DL	3"	PLAIN END	24"	670648226263
UA7DLB	3"	BELL END	24"	670648196993
UA7EL	3"	PLAIN END	30"	670648067774
UA7ELB	3"	BELL END	30"	670648197068
UA7FL	3"	PLAIN END	36"	670648067781
UA7FLB	3"	BELL END	36"	670648197143
UA7HL	3"	PLAIN END	48"	670648193527
UA7HLB	3"	BELL END	48"	670648197235
UA7DM	3-1/2"	PLAIN END	24"	670648054699
UA7EM	3-1/2"	PLAIN END	30"	670648054705
UA7FM	3-1/2"	PLAIN END	36"	670648067804

Part Number	Trade Size	Type	Radius "B"	EACH UPC
UA7DN	4"	PLAIN END	24"	670648226270
UA7DNB	4"	BELL END	24"	670648197013
UA7EN	4"	PLAIN END	30"	670648067873
UA7ENB	4"	BELL END	30"	670648197082
UA7FN	4"	PLAIN END	36"	670648067880
UA7FNB	4"	BELL END	36"	670648197167
UA7HN	4"	PLAIN END	48"	670648067897
UA7HNB	4"	BELL END	48"	670648197259
UA7IN	4"	PLAIN END	60"	670648967265
UA7INB	4"	BELL END	60"	670648967272
UA7JN	4"	PLAIN END	72"	670648142693
UA7NNB	4"	BELL END	120"	670648339581
UA7RN	4"	PLAIN END	144"	670648142716
UA7SN	4"	PLAIN END	150"	670648226751
UA7SNB	4"	BELL END	150"	670648226768
UA7EP	5"	PLAIN END	30"	670648067927
UA7EPB	5"	BELL END	30"	670648055269
UA7FP	5"	PLAIN END	36"	670648067934
UA7FPB	5"	BELL END	36"	670648197174
UA7HP	5"	PLAIN END	48"	670648067941
UA7HPB	5"	BELL END	48"	670648197266
UA7IPB	5"	BELL END	60"	670648182682
UA7JP	5"	PLAIN END	72"	670648142709
UA7NPB	5"	BELL END	120"	670648226607
UA7RP	5"	PLAIN END	144"	670648142730
UA7SPB	5"	BELL END	150"	670648226782
UA7UP	5"	PLAIN END	240"	670648142723
UA7FR	6"	BELL END	36"	670648067989
UA7FRB	6"	BELL END	36"	670648197181
UA7HR	6"	PLAIN END	48"	670648067996
UA7HRB	6"	BELL END	48"	670648197273
UA7IR	6"	PLAIN END	60"	670648967289
UA7JR	6"	PLAIN END	72"	670648179514
UA7NR	6"	PLAIN END	120"	670648179521
UA7RRB	6"	BELL END	144"	670648356274

Carton Quantity = 1

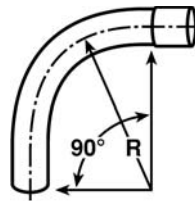

Part Number	Trade Size	Type	Radius "B"	EACH UPC
UA9CF	1"	PLAIN END	18"	670648067101
UA9CFB	1"	BELL END	18"	670648227239
UA9DF	1"	PLAIN END	24"	670648067415
UA9DFB	1"	BELL END	24"	670648227314
UA9EF	1"	PLAIN END	30"	670648067255
UA9EFB	1"	BELL END	30"	670648079470
UA9FF	1"	PLAIN END	36"	670648067323
UA9HF	1"	PLAIN END	48"	670648067453
UA9CG	1-1/4"	PLAIN END	18"	670648227253
UA9CGB	1-1/4"	BELL END	18"	670648196504
UA9DG	1-1/4"	PLAIN END	24"	670648068061
UA9DGB	1-1/4"	BELL END	24"	670648196559
UA9EG	1-1/4"	PLAIN END	30"	670648067309
UA9EGB	1-1/4"	BELL END	30"	670648055009
UA9FG	1-1/4"	PLAIN END	36"	670648067507
UA9FGB	1-1/4"	BELL END	36"	670648196702
UA9HG	1-1/4"	PLAIN END	48"	670648067460
UA9BHB	1-1/2"	BELL END	12"	670648967296
UA9CH	1-1/2"	PLAIN END	18"	670648067125
UA9CHB	1-1/2"	BELL END	18"	670648196511
UA9DH	1-1/2"	PLAIN END	24"	670648067118
UA9DHB	1-1/2"	BELL END	24"	670648196566
UA9EH	1-1/2"	PLAIN END	30"	670648067316
UA9EHB	1-1/2"	BELL END	30"	670648055184
UA9FH	1-1/2"	PLAIN END	36"	670648068139
UA9FHB	1-1/2"	BELL END	36"	670648196719
UA9HH	1-1/2"	PLAIN END	48"	670648067477
UA9CJ	2"	PLAIN END	18"	670648067408
UA9CJB	2"	BELL END	18"	670648196528
UA9DJ	2"	PLAIN END	24"	670648967166
UA9DJB	2"	BELL END	24"	670648196573
UA9EJ	2"	PLAIN END	30"	670648067170
UA9EJB	2"	BELL END	30"	670648196641
UA9FJ	2"	PLAIN END	36"	670648067187
UA9FJB	2"	BELL END	36"	670648196726
UA9HJ	2"	PLAIN END	48"	670648067194
UA9HJB	2"	BELL END	48"	670648196818
UA9JJ	2"	PLAIN END	72"	670648227741
UA9CK	2-1/2"	PLAIN END	18"	670648067149
UA9CKB	2-1/2"	BELL END	18"	670648196535
UA9DK	2-1/2"	PLAIN END	24"	670648167214
UA9DKB	2-1/2"	BELL END	24"	670648196580
UA9EK	2-1/2"	PLAIN END	30"	670648067224
UA9EKB	2-1/2"	BELL END	30"	670648196658
UA9FK	2-1/2"	PLAIN END	36"	670648067231
UA9FKB	2-1/2"	BELL END	36"	670648196733
UA9HK	2-1/2"	PLAIN END	48"	670648067248
UA9HKB	2-1/2"	BELL END	48"	670648196825
UA9CL	3"	PLAIN END	18"	670648067156
UA9CLB	3"	BELL END	18"	670648196542
UA9DL	3"	PLAIN END	24"	670648227383
UA9DLB	3"	BELL END	24"	670648196597
UA9EL	3"	PLAIN END	30"	670648227420
UA9ELB	3"	BELL END	30"	670648196665
UA9FL	3"	PLAIN END	36"	670648067286

Part Number	Trade Size	Type	Radius "B"	EACH UPC
UA9FLB	3"	BELL END	36"	670648196740
UA9HL	3"	PLAIN END	48"	670648067293
UA9HLB	3"	BELL END	48"	670648196832
UA9IL	3"	PLAIN END	60"	670648183269
UA9DM	3-1/2"	PLAIN END	24"	670648067200
UA9DMB	3-1/2"	BELL END	24"	670648196603
UA9EM	3-1/2"	PLAIN END	30"	670648067354
UA9EMB	3-1/2"	BELL END	30"	670648055191
UA9FM	3-1/2"	PLAIN END	36"	670648067330
UA9FMB	3-1/2"	BELL END	36"	670648196757
UA9HM	3-1/2"	PLAIN END	48"	670648067347
UA9HMB	3-1/2"	BELL END	48"	670648196849
UA9CNB	4"	BELL END	18"	670648186970
UA9DN	4"	PLAIN END	24"	670648067361
UA9DNB	4"	BELL END	24"	670648196610
UA9EN	4"	PLAIN END	30"	670648067378
UA9ENB	4"	BELL END	30"	670648196689
UA9FN	4"	PLAIN END	36"	670648067385
UA9FNB	4"	BELL END	36"	670648196764
UA9HN	4"	PLAIN END	48"	670648067392
UA9HNB	4"	BELL END	48"	670648196856
UA9IN	4"	PLAIN END	60"	670648227666
UA9INB	4"	BELL END	60"	670648227673
UA9JN	4"	PLAIN END	72"	670648227789
UA9MN	4"	PLAIN END	108"	670648967319
UA9RN	4"	PLAIN END	144"	670648142761
UA9SNB	4"	BELL END	150"	670648967333
UA9VN	4"	PLAIN END	300"	670648142778
UA9EP	5"	PLAIN END	30"	670648067422
UA9EPB	5"	BELL END	30"	670648196696
UA9FP	5"	PLAIN END	36"	670648067439
UA9FPB	5"	BELL END	36"	670648196771
UA9HP	5"	PLAIN END	48"	670648067446
UA9HPB	5"	BELL END	48"	670648196863
UA9IP	5"	PLAIN END	60"	670648227680
UA9IPB	5"	BELL END	60"	670648227697
UA9JP	5"	PLAIN END	72"	670648142754
UA9TP	5"	PLAIN END	180"	670648193817
UA9VP	5"	PLAIN END	300"	670648142785
UA9FR	6"	PLAIN END	36"	670648067484
UA9FRB	6"	BELL END	36"	670648196788
UA9HR	6"	PLAIN END	48"	670648067491
UA9HRB	6"	BELL END	48"	670648196870
UA9IR	6"	PLAIN END	60"	670648227703
UA9IRB	6"	BELL END	60"	670648227710
UA9JRB	6"	BELL END	72"	670648145199
UA9LRB	6"	BELL END	96"	670648967302
UA9MR	6"	PLAIN END	108"	670648967326
UA9RRB	6"	BELL END	144"	670648356236
UA9SR	6"	PLAIN END	150"	670648126334
UA9TRB	6"	BELL END	180"	670648120134
UA9VR	6"	PLAIN END	300"	670648967340

Carton Quantity = 1

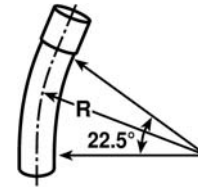
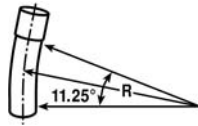

Part Number	Trade Size	Type	Carton Quantity	EACH UPC
UB3AL	3"	PLAIN END	25	670648179194
UB3AR	6"	PLAIN END	1	670648173512

Part Number	Trade Size	Type	Carton Quantity	EACH UPC
UB5AL	3"	PLAIN END	20	670648177015
UB5AN	4"	PLAIN END	12	670648179392
UB5AP	5"	PLAIN END	1	670648182644
UB5APB	5"	BELL END	1	670648187137

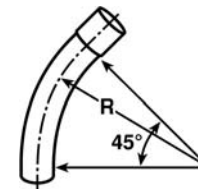
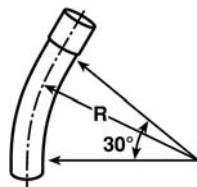

Part Number	Trade Size	Type	Carton Quantity	EACH UPC
UB6AD	1/2"	PLAIN END	50	670648063615
UB6AE	3/4"	PLAIN END	25	670648063622
UB6AF	1"	PLAIN END	25	670648063639
UB6AG	1-1/4"	PLAIN END	20	670648063646
UB6AH	1-1/2"	PLAIN END	25	670648063653
UB6AJ	2"	PLAIN END	20	670648063660
UB6AK	2-1/2"	PLAIN END	20	670648063677
UB6AL	3"	PLAIN END	18	670648063684
UB6AN	4"	PLAIN END	10	670648063707
UB6AP	5"	PLAIN END	1	670648063721
UB6AR	6"	PLAIN END	1	670648063745

Part Number	Trade Size	Type	Carton Quantity	EACH UPC
UB7AD	1/2"	PLAIN END	50	670648063417
UB7AE	3/4"	PLAIN END	25	670648063424
UB7AF	1"	PLAIN END	20	670648063431
UB7AG	1-1/4"	PLAIN END	20	670648063448
UB7AH	1-1/2"	PLAIN END	20	670648063455
UB7AJ	2"	PLAIN END	20	670648063462
UB7AK	2-1/2"	PLAIN END	20	670648063479
UB7AL	3"	PLAIN END	1	670648063486
UB7AN	4"	PLAIN END	1	670648063509
UB7AP	5"	PLAIN END	1	670648063523
UB7APB	5"	BELL END	1	670648187120
UB7AR	6"	PLAIN END	1	670648063738

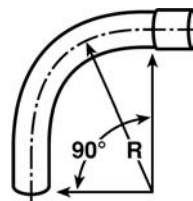

Part Number	Trade Size	Type	Carton Quantity	EACH UPC
UB9AD	1/2"	PLAIN END	50	670648063219
UB9AE	3/4"	PLAIN END	35	670648063226
UB9AF	1"	PLAIN END	20	670648063233
UB9AG	1-1/4"	PLAIN END	30	670648063240
UB9AH	1-1/2"	PLAIN END	30	670648063257
UB9AJ	2"	PLAIN END	20	670648063264
UB9AK	2-1/2"	PLAIN END	10	670648063271
UB9AL	3"	PLAIN END	1	670648063288
UB9AN	4"	PLAIN END	1	670648063301
UB9AP	5"	PLAIN END	1	670648063325
UB9APB	5"	BELL END	1	670648187113

Schedule 80 PVC Elbows – Special Radius

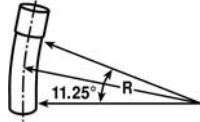

Part Number	Trade Size	Type	Radius	Carton Quantity	EACH UPC
UB3FP	5"	PE	36"	1	670648183993

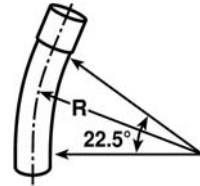

Part Number	Trade Size	Type	Radius	Carton Quantity	EACH UPC
UB5DHB	1-1/2"	BE	24"	20	670648185003
UB5DJB	2"	BE	24"	20	670648185010
UB5FJB	2"	BE	36"	25	670648187069
UB5HJ	2"	PE	48"	20	670648223361
UB5DKB	2-1/2"	BE	24"	15	670648185027
UB5DL	3"	PE	24"	1	670648161663
UB5DLB	3"	BE	24"	10	670648185034
UB5FLB	3"	BE	36"	1	670648187083
UB5DN	4"	PE	24"	1	670648173505
UB5DNB	4"	BE	24"	5	670648185041
UB5FN	4"	PE	36"	1	670648967357
UB5FNB	4"	BE	36"	1	670648187106
UB5HN	4"	PE	48"	1	670648223347
UB5FP	5"	PE	36"	1	670648184006
UB5HP	5"	PE	48"	1	670648223354

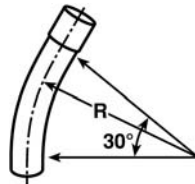

Part Number	Trade Size	Type	Radius	Carton Quantity	EACH UPC
UB6FN	4"	PE	36"	1	670648180305
UB6FR	6"	PE	36"	1	670648180312

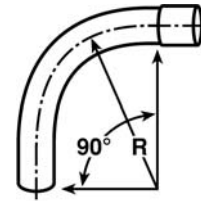
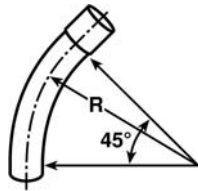

Part Number	Trade Size	Type	Radius	Carton Quantity	EACH UPC
UB7CF	1"	PE	18"	1	670648055832
UB7DF	1"	PE	24"	1	670648055849
UB7FF	1"	PE	36"	1	670648055863
UB7HF	1"	PE	48"	1	670648055870
UB7DG	1-1/4"	PE	20"	1	670648055894
UB7FG	1-1/4"	PE	36"	1	670648055917
UB7HG	1-1/4"	PE	48"	1	670648055924
UB7CH	1-1/2"	PE	18"	1	670648055931
UB7DH	1-1/2"	PE	24"	1	670648055948
UB7DHB	1-1/2"	BE	24"	1	670648185058
UB7FH	1-1/2"	PE	36"	1	670648193732
UB7HH	1-1/2"	PE	48"	1	670648055962
UB7CJ	2"	PE	18"	1	670648193800
UB7DJ	2"	PE	24"	1	670648193855
UB7DJB	2"	BE	24"	1	670648185065
UB7FJ	2"	PE	36"	1	670648193954
UB7FJB	2"	BE	36"	1	670648187052
UB7HJ	2"	PE	48"	1	670648055986
UB7DK	2-1/2"	PE	24"	1	670648056006
UB7DKB	2-1/2"	BE	24"	1	670648185072
UB7FK	2-1/2"	PE	36"	1	670648193749
UB7HK	2-1/2"	PE	48"	1	670648056020
UB7CL	3"	PE	18"	1	670648341126
UB7DL	3"	PE	24"	1	670648194357
UB7DLB	3"	BE	24"	1	670648185089
UB7FL	3"	PE	36"	1	670648194456
UB7FLB	3"	BE	36"	1	670648187076
UB7HL	3"	PE	48"	1	670648194500
UB7DN	4"	PE	24"	1	670648194852
UB7DNB	4"	BE	24"	1	670648185096
UB7FN	4"	PE	36"	1	670648194951
UB7FNB	4"	BE	36"	1	670648187090
UB7HN	4"	PE	48"	1	670648195002
UB7FP	5"	PE	36"	1	670648195200
UB7HP	5"	PE	48"	1	670648195255
UB7FR	6"	PE	36"	1	670648056075
UB7HR	6"	PE	48"	1	670648193848
UB7IR	6"	PE	60"	1	670648176018

Part Number	Trade Size	Type	Radius	Carton Quantity	EACH UPC
UB9CF	1"	PE	18"	1	670648190533
UB9DF	1"	PE	24"	1	670648191066
UB9FF	1"	PE	36"	1	670648191219
UB9HF	1"	PE	48"	1	670648191257
UB9CG	1-1/4"	PE	18"	1	670648190540
UB9DG	1-1/4"	PE	24"	1	670648191073
UB9FG	1-1/4"	PE	36"	1	670648191226
UB9HG	1-1/4"	PE	48"	1	670648191264
UB9CH	1-1/2"	PE	18"	1	670648190557
UB9DH	1-1/2"	PE	24"	1	670648190601
UB9DHB	1-1/2"	BE	24"	1	670648185102
UB9FH	1-1/2"	PE	36"	1	670648190700
UB9HH	1-1/2"	PE	48"	1	670648191271
UB9CJ	2"	PE	18"	1	670648190809
UB9DJ	2"	PE	24"	1	670648190854
UB9DJB	2"	BE	24"	1	670648158861
UB9FJ	2"	PE	36"	1	670648190953
UB9FJB	2"	BE	36"	1	670648187045
UB9HJ	2"	PE	48"	1	670648191004
UB9CK	2-1/2"	PE	18"	1	670648190816
UB9DK	2-1/2"	PE	24"	1	670648191103
UB9DKB	2-1/2"	PE	24"	1	670648341515
UB9FK	2-1/2"	PE	36"	1	670648191202
UB9FKB	2-1/2"	BE	36"	1	670648111637
UB9HK	2-1/2"	PE	48"	1	670648191295
UB9CL	3"	PE	18"	1	670648191301
UB9DL	3"	PE	24"	1	670648191356
UB9DLB	3"	BE	24"	1	670648341522
UB9FL	3"	PE	36"	1	670648191455
UB9FLB	3"	BE	36"	1	670648229196
UB9HL	3"	PE	48"	1	670648191509
UB9DN	4"	PE	24"	1	670648191851
UB9DNB	4"	BE	24"	1	670648185119
UB9FN	4"	PE	36"	1	670648191950
UB9FNB	4"	BE	36"	1	670648229219
UB9HN	4"	PE	48"	1	670648192001
UB9HNB	4"	BE	48"	1	670648229271
UB9NN	4"	PE	120"	1	670648213782
UB9FP	5"	PE	36"	1	670648192209
UB9HP	5"	PE	48"	1	670648192254
UB9IP	5"	PE	60"	1	670648189490
UB9FR	6"	PE	36"	1	670648191240
UB9HR	6"	PE	48"	1	670648229318
UB9IR	6"	PE	60"	1	670648176025