

800 Series Floor Box, An Economical Single Service Solution

The 800 Series Semi-Adjustable Floor Box provides an excellent and economical activation solution for the low density power or communication requirements in open space areas. The 800 Series Floor Box is available in stamped steel and cast iron construction and is suitable for both on or above grade applications. The 800 Series gives an aesthetic, low profile appearance that allows you to activate your wiring without obstructions. Typical applications would be in any large open space area. Activations for these boxes can be flush or pedestal type. The flush activation option offers an aesthetic brass look. The 525 Series Service Fitting can be used with the 800 Series Floor Box to offer a die-cast aluminum pedestal activation. All activation covers are interchangeable for stamped steel and cast iron boxes.



800 Series steel and cast iron floor boxes.

Features & Benefits

- **Stamped steel construction.** Meets requirements for above grade applications. Lower cost alternative to cast iron boxes on above grade applications.
- **Activation flush or pedestal.** Flexibility to meet power or data wiring requirements. Variety of aesthetically pleasing cover options.
- **Single power receptacles available.** An inexpensive option for low density power requirements for open space areas.
- **Covers are interchangeable for cast iron and stamped steel.** More activations to meet any decor.

800 Series Floor Box Order Information

Catalog No./Item

Description/Specifications

800LCK

Steel Floor Box – Adjustable before and after the concrete pour. Sold without conversion kit. 4 3/16" W x 3" H [106mm x 76mm].

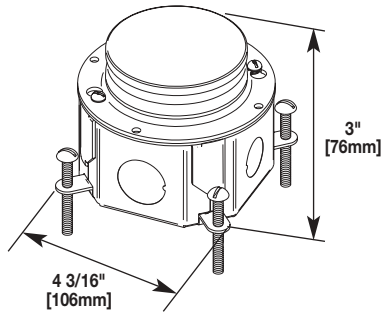

Technical Specifications

Conduit Knockouts	Adjustment Before Pour	Adjustment After Pour	Cubic Inch Capacity
Sides Two 1/2" & Two 3/4" Trade Size KOs Bottom Two 1/2" & Two 3/4" Trade Size KOs	2 3/4" [70mm] vertical	1/2" [12.7mm] vertical	23.6 cu in. [387 cu cm]

800CILCK

Cast Iron Floor Box – Adjustable before and after the concrete pour. Sold without conversion kit. 4 3/16" W x 3 3/8" H [106mm x 86mm].

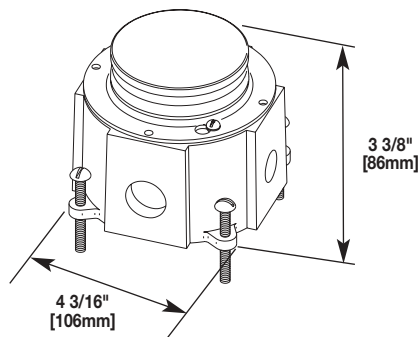

Technical Specifications

Conduit Knockouts	Adjustment Before Pour	Adjustment After Pour	Cubic Inch Capacity
Sides Two 1/2" & Two 3/4" Trade Size KOs	2 3/4" [70mm] vertical	1/2" [12.7mm] vertical	28.3 cu in. [464 cu cm]

800 Series Floor Box Cover Plates and Accessories

Catalog No./Item

Description/Specifications

825CK

Brass or Brushed Aluminum Conversion Kit Cover – Includes one 825A 2 1/4" [57mm] diameter plug, one 825C, one 825L, and one 825N. Total diameter of cover is 2 5/8" [67mm].

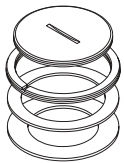

825CK-1

Brass or Brushed Aluminum Conversion Kit Cover – Includes one 825A-1 1" [25mm] diameter plug, one 825C-1, one 825L, and one 825N. Total diameter of cover is 2 5/8" [67mm].

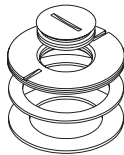

825CK-3/4

Brass or Brushed Aluminum Conversion Kit Cover – Includes one 825A-3/4 3/4" [219.1mm] diameter plug, one 825C-3/4, one 825L, and one 825N. Total diameter of cover is 2 5/8" [67mm].

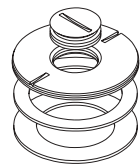

Catalog No./Item

Description/Specifications

825CK-1/2

Brass or Brushed Aluminum Conversion Kit Cover – Includes one 825A-1/2 1/2" [12.7mm] diameter plug, one 825C-1/2, one 825L, and one 825N. Total diameter of cover is 2 5/8" [67mm].

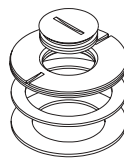

825CP

Brass Carpet Plate Assembly – Includes the 825A. Total diameter of cover is 2 5/8" [67mm].







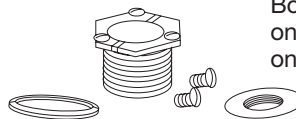





825SFCK

Conversion Kit – To fit 525 Series Service Fitting on 800 Series Boxes. Includes one 825C, one 825P-1, and one 1124L-1.

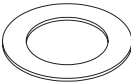
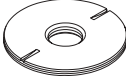

800 Series Floor Box Component and Replacement Parts

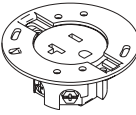
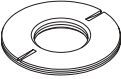
Catalog No./Item	Description/Specifications	Catalog No./Item	Description/Specifications
825A	Brass Abandon Plug – 2 1/4" [57mm] diameter. Use with 825CK brass conversion kit cover. 	825D	Adjusting Ring – For floor box. Allows 1/2" [12.7mm] of adjustment. 
825A-1/2	Brass Abandon Plug – 1/2" [12.7mm] diameter. Use with 825CK-1/2 brass conversion kit cover. 	825DE	Adjusting Ring Extension – Threads into 825D to provide additional 1" [25mm] height. 
825A-3/4	Brass Abandon Plug – 3/4" [19.1mm] diameter. Use with 825CK-3/4 brass conversion kit cover. 	825K	Cement Protector Cap 
825A-1	Brass Abandon Plug – 1" [25mm] diameter. Use with 825CK-1 brass conversion kit cover. 	825L	Gasket – For use with 825CK conversion kits. 
825C	Brass Floor Plate – With 2 1/4" [57mm] threaded opening. Use with 825CK brass conversion kit cover. 	825N	Support Disc – For use with 825CK conversion kits. 
825C-1/2	Brass Floor Plate – With 1/2" [12.7mm] threaded opening. Use with 825CK-1/2 brass conversion kit cover. 	825P-1	Service Fitting Adapter – Disc adapter for floor boxes to mount service fittings or stand pipes. 
825C-3/4	Brass Floor Plate – With 3/4" [19.1mm] threaded opening. Use with 825CK-3/4 brass conversion kit cover. 	825R15	Receptacle – 20 amp, 125 volt, three-wire grounded. 5-20R NEMA configuration. 
825C-1	Brass Floor Plate – With 1" [25mm] threaded opening. Use with 825CK-1 brass conversion kit cover. 		

WIREMOLD



Wiremold / Legrand

U.S. and International:

60 Woodlawn Street • West Hartford, CT 06110

1-800-621-0049 • FAX 860-232-2062 • Outside U.S. 860-233-6251

Canada:

570 Applewood Crescent • Vaughan, Ontario L4K 4B4

1-800-723-5175 • FAX 905-738-9721

