

Open System Communication Connectivity Solutions

Mounting industry standard communication devices in Wiremold Wire and Cable Management Systems has never been easier. The Wiremold Communication Module Series supports open system architecture by providing a variety of unloaded modules to accept devices from other manufacturers. These open system modules provide a flexible and aesthetically pleasing way to connect communication cabling at the point-of-use.



Shown: Dual and Single Unloaded Keystone Jack Modules.

Features & Benefits

- **Open system capabilities.** Unloaded modules are available to accept a wide range of industry standard keystone jacks, SC & ST fiber optic adapters, as well as, select proprietary solutions from AMP NET CONNECT, Avaya/Lucent and NORDX.
- **Wire management compatible.** Modules snap securely into Wiremold communication ready device brackets featuring 2A & 6A openings for an aesthetically pleasing look.
- **Installation and configuration ease.** Modules feature a front load snap-in design for ease of installation and allowing outlet configuration changes to be made quickly.
-  Listed.



*Communication modules provide a seamless point-of-use interface in Wiremold Wire and Cable Management Systems.
Shown: WallSource Multiservice Box, FloorSource Raised Floor Box and 5400 Series Raceway.*

6A Communication Opening

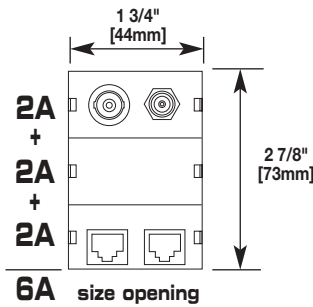

Open System Modules

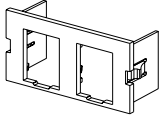
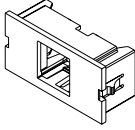
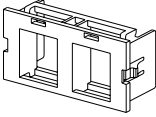
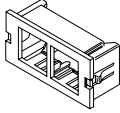
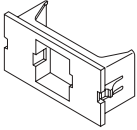
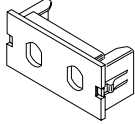
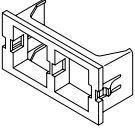
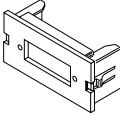
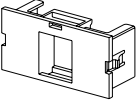
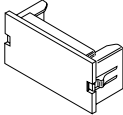
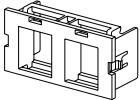
Catalog No./Item	Description/Specifications	Catalog No./Item	Description/Specifications
CM2-U2TJ 	2A, Dual Flushmount Unloaded Ortronics® TracJack® Module – For mounting two TracJack devices.	CM2-U1NOR 	2A, Single Flushmount NORDX/ CDT Unloaded Module – For use with MDVOFlex Jacks and Fiber Modules.
CM2-U2AMP 	2A, Single Unloaded AMP NETCONNECT Module – For mounting two AMP NETCONNECT SL Series devices.	CM2-U2NOR 	2A, Dual Flushmount NORDX/ CDT Unloaded Module – For use with MDVOFlex Jacks and Fiber Modules.
CM2-U1ATT 	2A, Single Unloaded Avaya/Lucent Module – For use with M-Series Jacks and LC Adapters.	CM2-U2ST 	2A, Dual Unloaded ST Adapter Module
CM2-U2ATT 	2A, Dual Unloaded Avaya/Lucent Module – For use with M-Series Jacks and LC Adapters.	CM2-U2SC 	2A, Unloaded Duplex SC Adapter Module
CM2-U1KEYA 	2A, Single Flushmount Unloaded Keystone Module – For mounting jacks with a latching area of 0.57" x 0.76" [14.5mm x 19.3mm].	CM2-BL 	Blank Insert
CM2-U2KEYA 	2A, Dual Flushmount Unloaded Keystone Module – For mounting jacks with a latching area of 0.57" x 0.76" [14.5mm x 19.3mm].		

NOTE: Standard color is Ivory, for other colors add suffix: "-WH" for White, "-GY" for Light Gray (matches aluminum and nonmetallic raceways), "-BK" for Black, and "-G" for Gray (matches Gray steel raceways).

Communication Module Mounting Bezels and Adapters

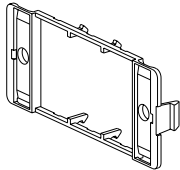
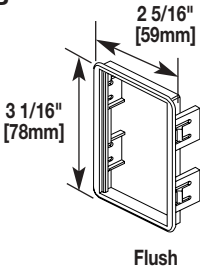
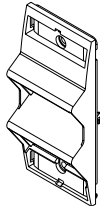
Catalog No./Item	Description/Specifications
CM-EPLA* 	End Plates – Includes two outlet identification labels with clear covers and two matching screw covers. Required for mounting Pass & Seymour Activate™ and Wiremold Open System communication modules into 4050, 5450, 5550, 2344SD-2A, 2344D-2A, WSX07-X, 40N2, 60N2, and CXN Series device brackets.
CM-MAB 	6A Mini Adapter Bezel 6A Opening – Must be purchased separately for mounting modules into Walker Systems where it is indicated they are not included. Available in ivory.
CM-ARA* 	Angled Raceway Adapter – With two outlet identification labels with clear covers and two matching screw covers. Provides angled exit in multichannel raceway systems and WallSource™ Boxes. Accepts two 2A size modules. Snaps into standard device mounting brackets.

* Standard color is Ivory, for other colors add suffix: "-WH" for White, or "-G" for Gray (matches Gray steel raceways).

CM Series Faceplates

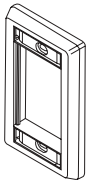
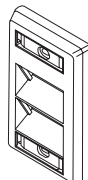
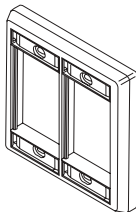
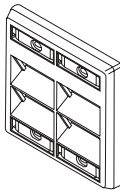
Catalog No./Item	Description/Specifications	Catalog No./Item	Description/Specification
CM-SFP 	Single Gang Faceplate – For mounting three CM2 Series modules or Pass & Seymour Activate Series device modules. <div style="float: right; text-align: right;"> ORT P&S OPEN </div>	CM-SAP 	Single Gang Angled Faceplate – For mounting three CM2 Series modules or Pass & Seymour Activate Series device modules. <div style="float: right; text-align: right;"> ORT P&S OPEN </div>
CM-DFP 	Double Gang Faceplate – For mounting six CM2 Series modules or Pass & Seymour Activate Series device modules. <div style="float: right; text-align: right;"> ORT P&S OPEN </div>	CM-DAP 	Double Gang Angled Faceplate – For mounting four CM2 Series modules or Pass & Seymour Activate Series device modules. <div style="float: right; text-align: right;"> ORT P&S OPEN </div>

NOTE: Add suffix "-WH" to indicate White finish.

WIREMOLD



Wiremold / Legrand

U.S. and International:

60 Woodlawn Street • West Hartford, CT 06110

1-800-621-0049 • FAX 860-232-2062 • Outside U.S. 860-233-6251

Canada:

570 Applewood Crescent • Vaughan, Ontario L4K 4B4

1-800-723-5175 • FAX 905-738-9721

